

COMETIC
GASKET



**POWERSPORT & V-TWIN
PERFORMANCE
GASKETS**



Cometic Gasket, Inc. - An Exclusive NASCAR Performance Product

COMETIC Custom Gaskets

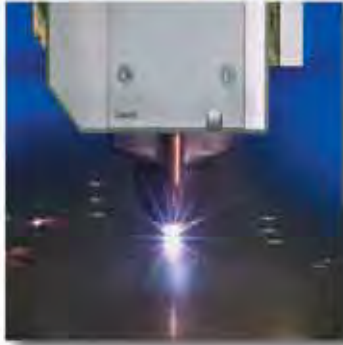
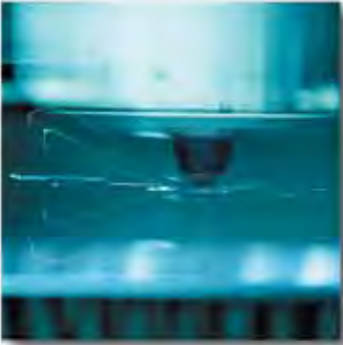

Cometic's custom gaskets can accommodate virtually any engine configuration from naturally aspirated, to the most exotic turbo and nitrous injected engines. Our commitment is to provide innovative, quality gaskets while maximizing your engine's power and performance. When customization is key, Cometic delivers!

Cometic has the ability to customize any gasket to meet your specific application. Need to change the bore size and/or thickness of a gasket? Or do you need a complete gasket design and execution? The process starts with a simple phone call. After Cometic's in-house Technical Sales Team understands your needs, they work directly with our design engineers to insure the gasket is drawn with state-of-the-art software and manufacture with the best materials possible with the most current and efficient manufacturing processes. If special tooling is required, we'll provide a pre-production estimate for approval. Your gasket is then made and shipped. The lead-time on bore and thickness changes is just three days. A complete gasket design takes just two weeks.

The passion for racing runs deep in our Technical Sales and Engineering Teams. We understand the importance of perfection in your next engine build because we are right there with you racing on weekends.

Call our Technical Sales Team today @ (440) 354-0777

visit www.cometic.com for listing of gasket materials and available thicknesses



Cometic Gasket, Inc., is a leading worldwide supplier of gaskets and engine sealing solutions for the Automotive Performance, Powersports, Original Equipment and Remanufactured Engine Industries.

All Cometic products are made in the United States with materials manufactured on American soil.

Launched by four partners including current Founder and CEO Bob Gorman in 1989, Cometic was originally dedicated exclusively to the powersports industry. Operating from a tiny 1,500 square foot manufacturing facility, the company produced a mere 900 SKUs in its first year.

Fast-forward to Cometic's 25th Anniversary in 2014. The company is now wholly owned by the Gorman family - and has grown into a global leader and innovator in the highly competitive engine supplier marketplace.

Housed in a 70,000 square-foot, state-of-the-art R&D and manufacturing center in Concord, Ohio, Cometic Gasket has maintained its deep roots in the powersports industry while expanding to service the Domestic Automotive, Sport Compact, V-twin, Marine, Diesel, Agricultural, Industrial and Stationary Power markets.

Today, Cometic Gasket offers over 85,000 SKUs, shipping gaskets and engine sealing solutions across the globe. Cometic is dedicated to customer satisfaction and provides quality products, delivered on time at a competitive price, designed for each customer's specific application. Cometic is an industry leader in manufacturing processes and committed to pairing the highest possible

quality materials with knowledgeable personnel. Cometic is also dedicated to continually improving all areas of its operations through employee development and involvement, as well as continual and comprehensive reviews of customer feedback.

To ensure superior performance across a wide variety of engine types and sizes, Cometic manufactures gaskets from a comprehensive range of materials. Whether the situation calls for the latest in advanced technology like the MLS (Multi-Layer Steel) Gasket, or a synthetic blend such as Aramid Fiber, Cometic finds a solution. Cometic stays on the forefront of gasket design technology by utilizing in-house dynamometers and engine assembly rooms to bring its distributors, retailers and ultimately the end-user, the most reliable gaskets available today.

Cometic combines advanced materials with the most current manufacturing processes to provide custom-tailored solutions to meet the needs of each individual customer. Engineers analyze the environment in which the gasket will perform, select the proper material, and apply the appropriate technology to offer the best-performing gaskets available in today's ever-changing marketplace. Cometic gaskets are the industry standard for championship-winning teams across multiple disciplines of both professional and amateur motorsports.



WATCH OUR NEW VIDEOS

YouTube Channel: [CometicGasket](https://www.youtube.com/CometicGasket)



Cometic Gasket Corporate Video



Cometic Gasket Performance Video



Cometic Gasket- "I'm a sore loser"

www.cometic.com

[facebook.com/cometic](https://www.facebook.com/cometic)

[@CometicGasket](https://www.instagram.com/CometicGasket)

Performance Powersports & V-Twin Products Available for:

Artic Cat
Bombardier
Cobra
Gas Gas

Honda
Husaberg
Husqvarna
Kawasaki

Cometic Products

Dirt | ATV | UTV | PWC

Top-End Kits | Bottom-End Kits | Clutch and Mag Kits | Crank Seals | Individual Gaskets | Engine Seal Kits

Today's lightweight engines are producing more horsepower, higher cylinder pressures, clamp loads and extreme temperatures. Our commitment is to provide innovative, quality gaskets while maximizing your engine's power and performance. Cometic's gaskets are proudly made in the USA with materials manufactured on American soil. We are constantly updating and adding models to our ever growing library of gaskets.

Be sure to check out our NEW Clutch and Mag Kits made from AFM Material. AFM will not stick to the engine case making replacement quick and easy, no more scraping. The aluminum core gives the gasket strength for a superior seal and prevents the gasket from weeping or crawling out. All gasket kits (Top-End, Bottom-End, Clutch and Mag) are sold with the proper amount of gaskets for one application. Need just one gasket, not the entire kit? No problem, we offer individual gaskets.

Cometic is a proud sponsor of Ricky Carmichael, Team Green, The Orange Brigade & Kawasaki Factory Motocross to name a few.

Cycle Street

Head Gaskets | Base Gaskets | Engine Case Kits

For today's hi-horse power streetbikes, Cometic offers MLS head gaskets, base gaskets and engine case rebuild kits utilizing our best materials available! We have a complete line of streetbike applications from new to old.

Cometic is an industry leader in manufacturing processes and committed to pairing the highest possible quality materials with knowledgeable personnel. Cometic stays on the forefront of gasket design technology by utilizing in-house dynamometers and engine assembly rooms to bring its distributors, retailers and ultimately the end-user, the most reliable gaskets available today.



Top-End Kit

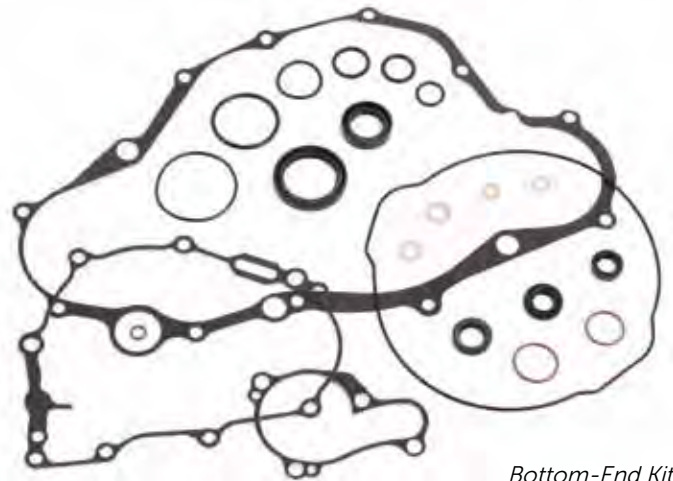

Bottom-End Kit



MLS Head Gasket cross section

KTM
LEM
Polaris
Suzuki

Yamaha
Can-Am Bombardier UTV
Aprilia
Ducati

Triumph
Harley-Davidson
Arctco
Sea Doo

Ski-Doo
John Deere
Rotax

Engine Seal Kits



V-Twin Kit



Clutch and Mag Kit

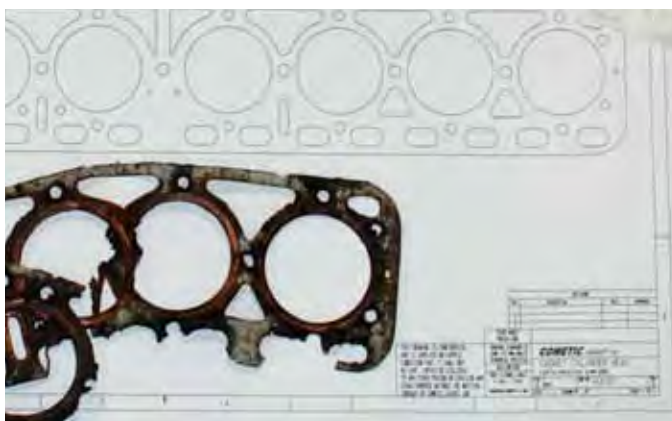
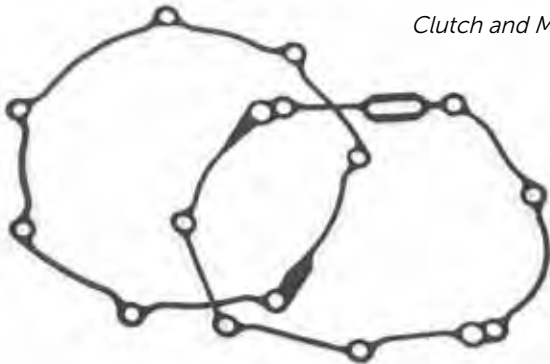

Harley-Davidson® | V-Twin

**Head Gaskets | Base Gaskets | Engine Only Kits | Rocker Box Kits
| Primary Kits | Transmission Kits**

Cometic Gasket has been servicing the American V-Twin Industry for over 25 years. Cometic offers a full line of gaskets for models from 1936 through current day models. Our gaskets can be ordered individually or as complete kits to do the entire job. Cometic also offers full on custom gaskets as well for shelf stock prices. So whether it's a stock bike or a fire breathing all out race machine Cometic has you covered.

All of Cometic's gaskets and seals have been tested on both the street and the track as well as vigorous Dyno shakedown. Rest assured every gasket has been methodically thought out before it is used in any application. Cometic uses it's EST "Extreme Sealing Technology" philosophy while making every gasket. Demand the best, Cometic to seal your engine.

Snowmobile

**Complete Kits | Top-End Kits | Exhaust Kits | Intake Kits | Power
Valve Kits | Crank Seal Kits**

Cometic's Snowmobile gaskets and gasket kits are used by professionals in high-performance machines and as OE replacements worldwide.

Cometic combines advanced materials with the most current manufacturing processes to provide custom-tailored solutions to meet the needs of each individual customer. Engineers analyze the environment in which the gasket will perform, select the proper material, and apply the appropriate technology to offer the best-performing gaskets available in today's ever-changing marketplace.

Custom Gaskets

Need to change the bore size and/or thickness of a gasket? Or do you need a complete gasket design and execution?

The process starts with a simple phone call. After Cometic's in-house Technical Sales Team understands your needs, they work directly with our design engineers to insure the gasket is drawn with state-of-the-art software and manufactured with the best materials possible with the most current and efficient manufacturing processes. If special tooling is required, we'll provide a pre-production estimate for approval. Your gasket is then made and shipped. The lead-time on bore and thickness changes is just three days. A complete gasket design takes just two weeks.

Start with a simple phone call:
(440) 354-0777 or (800) 752-9850



GASKET MATERIALS

MLS® Multi Layer Steel Gaskets

The Cometic MLS gasket is comprised of three to five layers of Stainless Steel. Cometic uses Stainless steel for increased strength, its ability to rebound and corrosion resistance. The outer layers of the gasket are embossed and coated on both sides with a Viton rubber material designed to meet the demands of a variety of harsh sealing environments, load conditions and surface finishes. The Viton coating is heat resistant to 250C or 482F.

The center or shim layer of the gasket is comprised of an uncoated Stainless Steel layer, which can be varied to accommodate multiple thickness requirements. The MLS gasket is ideal for any kind of head and block combination.

By design the MLS gasket promotes an even torque load across the sealing surface allowing for measurable reduced bore distortion.

AFM (Aluminum Foam Material)

AFM is a chemically blown, compounded nitrile synthetic rubber bonded to an aluminum core with temperature resistance of over 250F. AFM material has an 85% recovery while maintaining strong torque retention. AFM does not require gasket sealers or re-tightening.

Available thickness: .018", .032", .060"

Rubber Coated Stainless Steel

A stainless steel core with a .001" thick coating of viton rubber on both sides.

Available thickness: .010", .014", .020"

Aramid Fiber

Is a premium hi-temperature, hi-density creep resistant material that requires no re-torquing and is fuel resistant. All Cometic fiber materials are asbestos free and require no additional sealants.

Available thickness: .012", .015", .020", .031", .039", .047", .060", .094", .125", .188

Copper (Dead Soft)

Available thickness: .005", .010", .016", .020", .027", .032", .043", .050", .063", .080", .094"

Aluminum

Solid material ideal for spacers and shims.

Available thickness: .010", .016", .020", .025", .032", .040", .050", .063", .080", .100", .125", .188", .250", .313", .375", .500"

Viton coated embossed outer layer

Stainless steel shim layer

Viton coated embossed outer layer

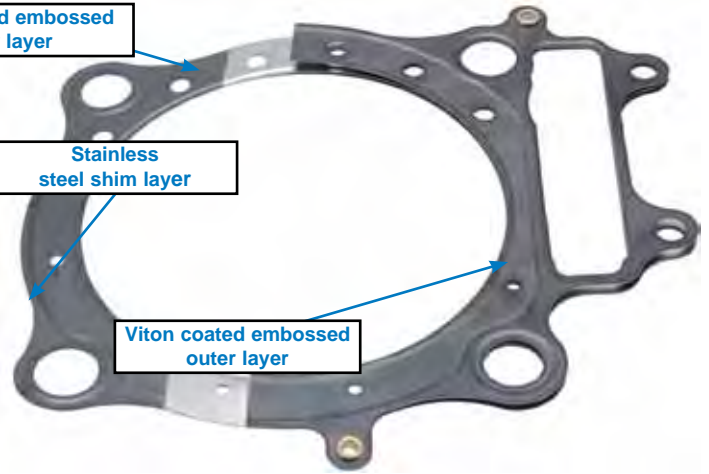

Available thickness:

.027", .030", .036", .040", .045", .051", .060", .066", .070", .075", .080", .086", .092", .098", 120"



The NASCAR Performance® logo and word mark are used under license by the National Association for Stock Car Auto Racing Inc.

Cometic Gasket - An Exclusive NASCAR Performance® Product

Top End Kits

Fit 2-Stroke and 4-Stroke applications and are supplied with the necessary gaskets and seals for a complete top end build. See your specific model for a detailed component listing. All components are also available individually.



Bottom End Kits

Fit 2-Stroke and 4-Stroke applications and are supplied with the necessary gaskets and seals for a complete bottom end build. Some applications will contain our new Oil Seal Kits. See your specific model for a detailed component listing. All components are also available individually.



Oil Seal Kits

Complete Oil Seal Kits fit 2-Stroke and 4-Stroke applications and contain all the required oil seals to rebuild a bottom end. All components are also available individually.



Clutch & Mag Kits

Fit 2-Stroke and 4-Stroke applications and use AFM gaskets and/or O-rings, for when a quick Clutch or Timing Inspection are needed, or just to have a spare for frequently damaged covers. All components are also available individually.



TABLE OF CONTENTS

| | Pg.# | | Pg.# | | Pg.# |
|-----------------------------|------|---|------|--|------|
| Arctic Cat UTV | 6 | Suzuki | 81 | EST Big Twin EVO Motor Kits | 147 |
| Can-Am Bombardier UTV | 6 | Yamaha | 98 | Replacement Gaskets, Seals, O-Rings | |
| Honda UTV | 7 | Aprilia | 123 | Transmission Kits | 152 |
| Kawasaki UTV | 7 | Ducati | 123 | EST Shovelhead & Panhead Motor Kits | 154 |
| Polaris UTV | 7 | Honda | 123 | Replacement Gaskets, Seals, O-Rings | |
| Yamaha UTV | 9 | Kawasaki | 125 | EST EVO Sportster Motors Sportster & Buell | 157 |
| Arctic Cat | 10 | KTM | 130 | Iron Sportster Motor Kits | 161 |
| Bombardier | 10 | Polaris | 130 | Replacement Gaskets, Seals, O-Rings | |
| Cobra | 11 | Suzuki | 130 | Rotax 600, Rotax 250 Gaskets | 164 |
| Gas Gas | 13 | Triumph | 134 | Polaris Victory V92C Head & Base Gaskets ... | 164 |
| Honda | 14 | Yamaha | 135 | HD Gasket Display Boards | 165 |
| Husaberg | 38 | Personal Watercraft | 137 | Ison Racing Engine Services | 173 |
| Husqvarna | 39 | HARLEY-DAVIDSON GASKETS | | | |
| Kawasaki | 41 | AFM Series Gaskets | 138 | Cometic Apparel & Promotional Items | 176 |
| KTM | 62 | MLS Head & Base Gaskets | 140 | | |
| LEM | 79 | EVO Rocker Cover Gaskets | 142 | | |
| Polaris | 79 | EST Twin Cam Hi-Performance Gasket Kits ... | 143 | | |
| | | Replacement Gaskets, Seals, O-Rings | | | |



UTV Gaskets



Cometic Gasket - An Exclusive NASCAR Performance® Product

ARCTIC CAT UTV PROWLER 650



Base Cam Chain Clutch Cover Head

| Model | Year | Bore Size | Top End Kit | List Price | Component Part# | Component Description | List Price | OEM Part # |
|----------------|-------|-----------|-------------|------------|-----------------|-------------------------------|------------|------------|
| Prowler 650 | 06-12 | 98 mm | C7220 | \$65.93 | H1735SP3027S | Head Gasket 98mm Bore | \$35.72 | 0830-124 |
| | | 100 mm | C7022 | \$65.93 | H1735SP4027S | Head Gasket 100mm Bore | \$35.72 | 0830-124 |
| | | | | | B0647014RC | Base Gasket | \$6.19 | 0830-084 |
| | | | | | EX657 | Exhaust Gasket | \$9.37 | 0412-338 |
| | | | | | EC377032AFM | Cam Chain Tens. Gasket | \$3.35 | 0830-018 |
| | | | | | OS020 | 2 Req.-Cam Chain Tens. O-ring | \$1.03 | 0830-107 |
| | | | | | R22X2.5V | Coolant Line O-ring | \$2.21 | 0830-007 |
| | | | | | R45X3V | Intake O-ring | \$2.71 | 0830-090 |
| | | | | | R54X2V | 2 Req.-Valve Cover O-rings | \$4.14 | 0830-004 |

Bottom End Gaskets Available Separately

| Component Part# | Component Description | List Price | OEM Part # |
|-----------------|-----------------------|------------|------------|
| EC1142032AFM | Clutch Cover Gasket | \$30.95 | 0830-116 |
| EC1143032AFM | Magneto Cover Gasket | \$24.98 | 0830-128 |
| EC1141032AFM | Primary Cover Gasket | \$35.72 | 0830-174 |

PROWLER 700XT LTD

| Model | Year | Bore Size | Top End Kit | List Price | Component Part# | Component Description | List Price | OEM Part # |
|-----------------------|-------|-----------|-------------|------------|-----------------|----------------------------|-------------|------------|
| Prowler 700 XT LTD | 08-15 | 103.5mm | C3597-EST | \$5.93 | H2223SP4027S | Head Gasket | \$26.52 | 0830-112 |
| | | | | | | B0760014RC | Base Gasket | \$5.54 |
| | | | | | EX657 | Exhaust Gasket | \$6.19 | 0412-338 |
| | | | | | OS020 | Cam Chain Tensioner Gasket | \$1.03 | 0830-107 |
| | | | | | EC377032AFM | Cam Chain Tens. Gasket | 3.35 | 0830-018 |
| | | | | | 3186V | Valve Seals | \$4.99 | 0830-186 |
| | | | | | R22X2.5V | Water Outlet O-ring | \$2.21 | 0830-007 |
| | | | | | R124V | Valve Cover O-rings 2 req. | \$1.19 | 0830-215 |
| | | | | | R008B | Intake O-ring | \$0.11 | 0423-182 |
| | | | | | R124V | Oil Fill Cap O-ring | \$1.19 | 0830-215 |
| | | | | | R54X2V | Inspection Cap O-ring | \$4.14 | 0830-004 |

Bottom End Gaskets Available Separately

| Component Part# | Component Description | List Price | OEM Part # |
|-----------------|-----------------------|------------|------------|
| EC1142032AFM | Clutch Cover Gasket | \$30.95 | 0830-116 |
| EC1143032AFM | Magneto Cover Gasket | \$24.98 | 0830-128 |
| EC1141032AFM | Primary Cover Gasket | \$35.72 | 0830-174 |

CAN-AM/BOMBARDIER UTV COMMANDER 1000



Head Base

| Model | Year | Bore Size | Top End Kit | List Price | Component Part# | Component Description | List Price | OEM Part # |
|-------------------|-------|-----------|-------------|------------|-----------------|-------------------------|------------|------------|
| Commander 1000 | 11-16 | 92mm | C3459-EST | \$155.00 | H2653018S | Head Gasket 92mm 2 Req. | \$44.55 | 420630195 |
| | | 93mm | C3460-EST | \$155.00 | H2653SP1018S | Head Gasket 93mm 2 Req. | \$44.55 | |
| | | 94mm | C3461-EST | \$155.00 | H2653SP2018S | Head Gasket 94mm 2 Req. | \$44.55 | |
| | | 96mm | C3462-EST | \$155.00 | H2653SP5018S | Head Gasket 95mm 2 Req. | \$44.55 | |

| | | | | | | | | |
|--|--|--|--|--|------------|----------------------------|------------|-----------|
| | | | | | 3186V | Valve Stem Seal 8 Req. | \$4.99 ea. | 420230515 |
| | | | | | R117V | Cam Chain Tensioner O-ring | \$1.19 | 420430370 |
| | | | | | R15X1.5V | Cam Adjuster O-ring | \$1.13 | 420250890 |
| | | | | | EX696 | Header Gasket 2 Req. | \$10.28 | 707600317 |
| | | | | | B0895010RC | Base Gasket 2 Req. | \$15.24 | 420630210 |

Bottom End Gaskets Available Separately

| Component Part# | Component Description | List Price | OEM Part # |
|-----------------|-----------------------|------------|------------|
| EC1142032AFM | Clutch Cover Gasket | \$30.95 | 0830-116 |
| EC1143032AFM | Magneto Cover Gasket | \$24.98 | 0830-128 |
| EC1141032AFM | Primary Cover Gasket | \$35.72 | 0830-174 |



UTV Gaskets



Cometic Gasket - An Exclusive NASCAR Performance® Product

HONDA UTV

FL250 ODYSSEY

| Model | Year | Bore Size | Top End Kit | List Price | Component Part# | Component Description | List Price | OEM Part # |
|---------|-------|-----------|-------------|------------|-----------------|-----------------------|------------|---------------|
| FL250 | 73-77 | 72 mm | C7140 | \$25.55 | H0182043F | Head Gasket 72mm | \$19.28 | 12251-358-306 |
| Odyssey | | | | | B0137020F | Base Gasket 73-76 | \$6.25 | 12191-357-306 |
| | | | | | B0395020F | Base Gasket 77-84 | \$5.34 | 12191-381-306 |

FL350R ODYSSEY

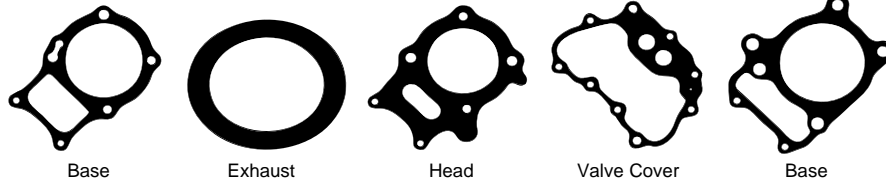

| Model | Year | Bore Size | Top End Kit | List Price | Component Part# | Component Description | List Price | OEM Part # |
|---------|------|-----------|-------------|------------|-----------------|-----------------------|------------|---------------|
| FL350R | 85 | 82 mm | C7229 | \$31.91 | B0204020F | Base Gasket | \$7.16 | 12191-VMO-772 |
| Odyssey | | | | | H0344043F | Head Gasket | \$22.32 | 12254-VMO-013 |

PILOT FL-400

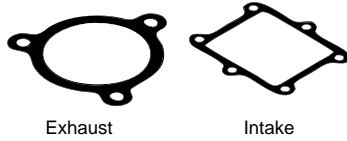

| Model | Year | Bore Size | Top End Kit | List Price | Component Part# | Component Description | List Price | OEM Part # |
|--------|-------|-----------|-------------|------------|-----------------|-----------------------|------------|-----------------------|
| Pilot | 89-91 | 82 mm | C7024 | \$35.72 | H0015043F | Head Gasket | \$22.32 | 12251-HE0-000 |
| FL-400 | | | | | B0020020F | Base Gasket | \$6.25 | 12191-HE0-000/010 |
| | | | | | EX009042AM | Exhaust Gasket | \$4.65 | 18291-HE0-000/010 |
| | | | | | IR004018AFM | Intake Gasket | \$3.80 | 14132-KAE-000/430-000 |

KAWASAKI UTV

KRF750 Teryx

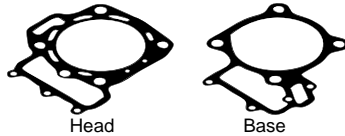

| Model | Year | Bore Size | Top End Kit | List Price | Component Part# | Component Description | List Price | OEM Part # |
|-------------|-------|-----------|-------------|------------|-----------------|----------------------------|------------|------------|
| KRF750 | 08-14 | 85mm | C3284-EST | \$122.60 | H2624SPA010S | Head Gasket 85mm | \$28.29 | 11004-0011 |
| Teryx (SXS) | | 90 mm | C3251-EST | \$122.60 | H2624SP1010S | Head Gasket 90mm | \$28.29 | 11004-0011 |
| | | | | | B0951020RC | Base Gasket | \$9.94 | 11061-0063 |
| | | | | | EX361 | Exhaust Gasket 2 req | \$5.50 | 11009-1894 |
| | | | | | WA114 | Coolant Drain Washer 2 Req | \$3.02 | |
| | | | | | R55X2V | Rocker Cap O-Ring 4 Req | \$2.34 | 92055-0112 |
| | | | | | R19X2V | Plug Cover O-Ring 2 Req | \$2.50 | 92055-1146 |
| | | | | | 3242V | Valve Stem Seals 8 Req | \$3.02 | 92049-1218 |

POLARIS UTV

RZR170

| Model | Year | Bore Size | Top End Kit | List Price | Component Part# | Component Description | List Price | OEM Part # |
|--------|-------|-----------|-------------|------------|-----------------|----------------------------|------------|------------|
| RZR170 | 09-16 | 61mm | C3596-EST | \$49.84 | B1318020RC | Cylinder Base Gasket | \$2.17 | 0454459 |
| | | | | | H4194010S | Cylinder Head Gasket | \$19.99 | 0454365 |
| | | | | | IR1308020F | Intake Manifold Gasket | \$2.95 | 0453451 |
| | | | | | R024V | Intake Manifold O-ring | \$1.19 | 0452459 |
| | | | | | R049B | Cylinder Head Cover O-ring | \$2.97 | 0454363 |
| | | | | | EC2131032AFM | Cylinder Head Breather | \$4.79 | 0454640 |
| | | | | | EC2132060AFM | Air Injection Gasket | \$2.39 | 0452808 |
| | | | | | EC2133060AFM | Air Injection Tube Gasket | \$2.39 | 0454454 |
| | | | | | EX886042AM | Exhaust Gasket | \$4.30 | 0453672 |
| | | | | | 3234V | Valve Seal | \$5.50 | 0452390 |
| | | | | | EC2134032AFM | Cam Chain Tensioner Gasket | \$1.24 | 0452417 |



UTV Gaskets



Cometic Gasket - An Exclusive NASCAR Performance® Product

POLARIS UTV RZR 570



| Model | Year | Bore Size | Exhaust Top End Kit | Head List Price | Component Part# | Component Description | List Price | OEM Part # |
|---------|------|-----------|---------------------|-----------------|-----------------|-----------------------|------------|------------|
| RZR 570 | 12 | 99mm | C3528-EST | \$79.02 | B1171014RC | Base Gasket | \$19.29 | 5254903 |
| | | | | | H3609021S | Head Gasket 99mm Bore | \$34.27 | 5813676 |
| | | | | | 3231V | Valve Seals 4 Req. | \$6.48 ea. | 3610161 |
| | | | | | EX817 | Exhaust Gasket | \$11.28 | 5253989 |
| | | | | | EC1654020RC | Cam Chain Tensioner | \$3.52 | 5813449 |

RANGER RZR 800

| Model | Year | Bore Size | Top End Kit | List Price | Component Part# | Component Description | List Price | OEM Part # |
|---------------|------|-----------|-------------|------------|-----------------|-----------------------|------------|------------|
| Ranger | 08 | 80 mm | C3250 | \$70.96 | H2761030S | Head Gasket 80mm Bore | \$51.73 | 5247359 |
| RZR 800 (SXS) | | 82 mm | C3507 | \$70.96 | H2761SP2030S | Head Gasket 82mm Bore | \$51.73 | |
| | | | | | B0940010RC | Base Gasket | \$11.60 | 5247360 |
| | | | | | EX452SP1064AM | Exhaust Gasket | \$15.51 | 5811511 |

RANGER RZR 800

| Model | Year | Bore Size | Top End Kit | List Price | Component Part# | Component Description | List Price | OEM Part # |
|---------------|-------|-----------|-------------|------------|-----------------|-----------------------|------------|------------|
| Ranger | 11-13 | 80 mm | C3506 | \$70.96 | H3657010S | Head Gasket 80mm Bore | \$51.73 | 5254357 |
| RZR 800 (SXS) | | 82 mm | C3508 | | H3657SP2010S | Head Gasket 82mm Bore | \$51.73 | |
| | | | | | B0940010RC | Base Gasket | \$11.60 | 5247360 |
| | | | | | EX452SP1064AM | Exhaust Gasket | \$15.51 | 5811511 |

XP900

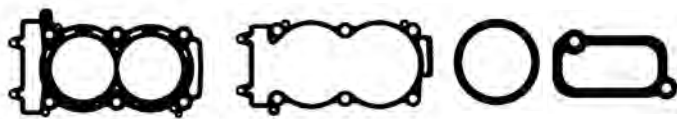

Head Base Cam Chain Tensioner Water Inlet

| Model | Year | Bore Size | Top End Kit | List Price | Component Part# | Component Description | List Price | OEM Part # |
|-------|-------|-----------|-------------|------------|-----------------|-------------------------|------------|------------|
| XP900 | 11-14 | 93.5mm | C3446-EST | \$85.66 | H3336018S | Head Gasket 93.5mm Bore | \$34.27 | 5813439 |
| | | 96mm | C3447-EST | \$85.66 | H3336SP1018S | Head Gasket 93.5mm Bore | \$34.27 | |
| | | | | | B1079014RC | Base Gasket | \$19.29 | 5253037 |
| | | | | | EC1654020RC | Cam Chain Tensioner | \$3.52 | 5813449 |
| | | | | | WP383032AFM | Water Inlet Gasket | \$3.74 | 5813521 |
| | | | | | EX817 | Exhaust Gasket 2 req. | \$11.28 | 5253989 |
| | | | | | 3231V | Valve Seals 8 Req. | \$6.48 ea. | 3610161 |

XP1000

| Model | Year | Bore Size | Top End Kit | List Price | Component Part# | Component Description | List Price | OEM Part # |
|--------|-------|-----------|-------------|------------|-----------------|-----------------------------|------------|------------|
| XP1000 | 14-15 | 94mm | C3546-EST | \$85.66 | H3892018S | Head Gasket 94mm Bore | \$34.27 | 5813737 |
| | | 96mm | C3563-EST | \$85.66 | H3892SP1018S | Head Gasket 96mm Bore | \$34.27 | 5813737 |
| | | | | | B1079014RC | Base Gasket | \$9.29 | 5253037 |
| | | | | | EC1654020RC | Cam Chain Tensioner Gasket | \$3.52 | 5813449 |
| | | | | | EX1408064AM | Header Gasket | \$12.20 | 3610184 |
| | | | | | 3254V | Valve Spring Seat With Seal | \$5.21 | 3610212 |
| | | | | | MR135 | Thermostat Seal | \$4.00 | 5413948 |
| | | | | | MR136 | Water Outlet O-ring | \$10.99 | 5813736 |



UTV Gaskets



Cometic Gasket - An Exclusive NASCAR Performance® Product

YAMAHA UTV RHINO 660

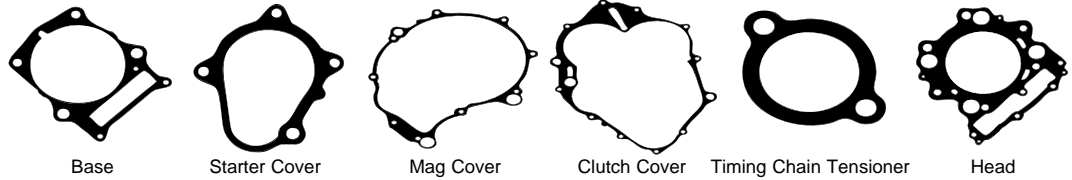

| Model | Year | Bore Size | Top End Kit | List Price | Component Part# | Component Description | List Price | OEM Part # | |
|-----------------|-------|-----------|-------------|------------|-----------------|-------------------------|--------------------------------|--------------|----------------------|
| RHINO 660 (SXS) | 04-07 | 100 mm | C7044-EST | \$89.44 | H1481SP2030S | Head Gasket 100mm | \$27.26 | 3YF-11181-00 | |
| | | 101 mm | C7900-EST | \$89.44 | H1481030S | Head Gasket 101mm | \$27.26 | | |
| | | 102 mm | C7798-EST | \$89.44 | H1191030S | Head Gasket 102mm | \$27.26 | | |
| | | 103 mm | C3042-EST | \$89.44 | H2174030S | Head Gasket 103mm | \$27.26 | | |
| | | | 105 mm | C7909-EST | \$89.44 | H1191SP1030S | Head Gasket 105mm | \$27.26 | |
| | | | | | | B0532010RC | Base Gasket | \$8.69 | 3YF-11351-00 |
| | | | | | | EX361 | Exhaust Gasket 2 Req. | \$5.50 | 3YF-14613-01-00 |
| | | | | | | EC584018AFM | Cam Chain Tensioner Gasket | \$3.58 | 4DW-12213-00 |
| | | | | | | 3187V | Valve Seal 5 Req. | \$3.02 | 5H0-12119-00-00 |
| | | | | | | R016B | Radiator Hose O-ring | \$0.74 | 93210-18417-00 |
| | | | | | | R113B | Valve Cover Plug O-ring | \$1.19 | 93210-13657-00 |
| | | | | | | R114S | Oil Tank O-ring | \$3.92 | 93210-16629-00 |
| | | | | | | R116B | Cam Chain Tensioner Cap O-ring | \$1.13 | 11101/93210-19522-00 |
| | | | | | | R117B | Dipstick O-ring | \$0.42 | 93210-21190-00 |
| | | | | | | R124B | Tappet Cover O-ring | \$3.92 | 93210-32172-00 |
| | | | | | | R155S | Cylinder Base O-ring | \$3.92 | 11256/93211-01467-00 |
| | | | | | | R71X2.5B | Intake Valve Adj. Cover O-ring | \$2.57 | 93210-71360-00 |
| | | | | | | WA081080C | Oil Line Washers 4 Req. | \$0.57 | 90430-08204 |
| | | | | | WA082063C | Oil line Washers 4 Req. | \$1.93 | 90430-10171 | |

RHINO 700



| Model | Year | Bore Size | Top End Kit | List Price | Component Part# | Component Description | List Price | OEM Part # | |
|-----------|-------|-----------|-------------|------------|-----------------|--------------------------|----------------------------|-----------------|-----------------|
| RHINO 700 | 06-13 | 103 mm | C3142-EST | \$89.44 | H2449027S | Head Gasket | \$40.55 | 3B4-11181-00-00 | |
| | | 104 mm | C3143-EST | \$89.44 | H2449SP2027S | Head Gasket 104mm Bore | \$40.55 | 3B4-11181-00-00 | |
| | | 105.5 mm | C3144-EST | \$89.44 | H2465027S | Head Gasket 105.5mm Bore | \$40.55 | 3B4-11181-00-00 | |
| | | | | | | B0855010RC | Base Gasket | \$9.47 | 1S3-11351-00-00 |
| | | | | | | EX361 | Exhaust Gasket 2 Req. | \$5.50 | 3YF-14613-01-00 |
| | | | | | | R034V | Throttle Body O-ring | \$3.00 | 4WV-14147-10-00 |
| | | | | | | R126V | Water Pump O-ring | \$1.19 | 93210-33786-00 |
| | | | | | | R131B | Thermostat O-ring | \$1.13 | 93210-41042-00 |
| | | | | | | R240V | Cam Cover O-ring | \$3.92 | 93210-96601-00 |
| | | | | | | R79X2.5V | Valve Cover O-rings 2 Req. | \$7.29 | 93210-78544-00 |
| | | | | | | 3187V | Valve Seal 4 Req. | \$3.02 | 5H0-12119-00-00 |
| | | | | | | EC584018AFM | Cam Chain Tensioner Gasket | \$3.58 | 4DW-12213-00 |

WOLVERINE R-SPEC YXE700

| Model | Year | Bore Size | Top End Kit | List Price | Component Part# | Component Description | List Price | OEM Part # |
|-----------------------|------|-----------|-------------|------------|-----------------|-----------------------------------|------------|-------------------|
| Wolverine Spec YXE700 | 2016 | 103mm | C3599-EST | \$64.58 | EC2098032AFM | Cam Chain Tensioner Gasket | \$2.46 | 2MB-E2213-00-R-00 |
| | | | | | MA0164 | Cam Chain Tensioner Crush Gasket | \$0.93 | 2MB-E21E2-00-00 |
| | | | | | B1306010RC | Cylinder Base Gasket | \$9.47 | 2MB-E1351-00-00 |
| | | | | | H4173023S | 103mm Bore Head Gasket | \$40.55 | 2MB-E1181-00-00 |
| | | | | | VC362018AFM | Valve Cover Breather Gasket | \$4.02 | 2MB-E131B-00-00 |
| | | | | | EX045 | Header Gasket | \$4.26 | 3EG-14613-00-00 |
| | | | | | WA117 | Oil Line Banjo Bolt Crush Gaskets | \$0.95 | 2MB-E1195-00-00 |
| | | | | | 3187V | Exhaust Valve Seal | \$1.48 | 2MB-E2129-00-00 |
| | | | | | 3187V | Intake Valve Seal | \$1.48 | 2MB-E2119-00-00 |
| | | | | | R125V | Water Outlet O-ring | \$1.19 | 2MB-E2843-00-00 |



MX/Dirt · Off-Road · ATV Gaskets



Cometic Gasket - An Exclusive NASCAR Performance® Product

ARCTIC CAT



| Model | Base Year | Cam Chain Bore Size | Clutch Cover EST | List Price | Head Component Part# | Component Description | List Price | OEM Part # |
|--------|-----------|---------------------|--------------------|------------|----------------------|------------------------|------------|------------|
| DVX400 | 03-08 | 92mm | Top End Kit | | H0949027S | Head Gasket 92mm | \$30.95 | 3402-841 |
| | | | C7978-EST | \$64.23 | H1045027S | Head Gasket 94mm | \$30.95 | |
| | | | C7979-EST | \$64.23 | H1045SP2027S | Head Gasket 96mm | \$30.95 | |
| | | | C3138-EST | \$64.23 | H1046027S | Head Gasket 97mm | \$30.95 | |
| | | 96mm | C7980-EST | \$64.23 | B0440027S | Base Gasket | \$28.51 | 3402-844 |
| | | | | | EC377032AFM | Cam Tensioner Gasket | \$3.35 | 3402-137 |
| | | | | | EX243 | Exhaust Gasket | \$2.79 | 3512-007 |
| | | | | | WA121 | Oil Drain Bolt Gasket | \$0.80 | 3003-290 |
| | | | | | 3160V | Valve Stem Seals 4 Req | \$5.50 | 3402-078 |
| | | | | | EC1030032AFM | Clutch Cover Gasket | 20.22 | 3446-357 |

Can-Am BOMBARDIER



| Model | Year | Bore Size | EST | List Price | Component Part# | Component Description | List Price | OEM Part # | |
|---------------|-------|-----------|--------------------|---------------------|-----------------|----------------------------|------------------------------|------------|-----------|
| DS450 | 10-13 | 97mm | Top End Kit | | H2858027S | Head Gasket 97mm | \$54.57 | 420650210 | |
| | | | C3266-EST | \$73.38 | H2858SP4027S | Head Gasket 99mm | \$54.57 | | |
| | | | C3453-EST | \$73.38 | H2858SP3027S | Head Gasket 100mm | \$54.57 | | |
| | | 99mm | | | B0970014RC | Base Gasket | \$18.12 | 420650390 | |
| | | | 100mm | | | WA117 | Temp Sensor Copper Seal ring | \$0.95 | 420250640 |
| | | | | | | 3225V | Valve Stem Seals | \$1.76 ea. | 420230510 |
| | | | | | WA165063A | Cam Chain Tens. Crush Seal | \$0.62 | 420430622 | |
| | | | | | EX1189043F | Exhaust Gasket | \$4.77 | 707600445 | |
| | | | | | | | | | |
| | | | | | | | | | |
| DS650 | 01-04 | 101 mm | Top End Kit | | H1155030S | Head Gasket 101mm | \$54.57 | 711650020 | |
| | | | C7711 | \$65.76 | H1830030S | Head Gasket 102mm | \$54.57 | 711650020 | |
| | | | C7721 | \$65.76 | H2403040S | Head Gasket 103mm | \$63.42 | 711650020 | |
| | | 102 mm | | | B0657020F | Base Gasket 101mm | \$11.18 | 711650010 | |
| | | | | | B0657020RC | Base Gasket 102mm | \$11.18 | | |
| 105.5 mm | | | B0657SP2031F | Base Gasket 105.5mm | \$11.18 | | | | |
| Outlander 400 | 03-14 | 92mm | Top End Kit | | H2653018S | 92mm Head Gasket | \$44.55 | 420630195 | |
| | | | C3489-EST | \$80.07 | H2653SP1018S | 93mm Head Gasket | \$44.55 | | |
| | | | C3490-EST | \$80.07 | H2653SP2018S | 94mm Head Gasket | \$44.55 | | |
| | | | C3491-EST | \$80.07 | H2653SP5018S | 95mm Head Gasket | \$44.55 | | |
| | | 93mm | | | 3186V | Valve Stem Seal 4 Required | \$4.99 ea. | 420230515 | |
| | | | 94mm | | | R117V | Cam Chain Tensioner O-ring | \$1.19 | 420430370 |
| | | | | | | R15X1.5V | Cam Adjuster O-ring | \$1.13 | 420250890 |
| | | | 96mm | | | EX696 | Header Gasket | \$10.28 | 707600317 |
| | | | | | | B0895010RC | Base Gasket | \$15.24 | 420630210 |



MX/Dirt · Off-Road · ATV Gaskets



Cometic Gasket - An Exclusive NASCAR Performance® Product

Can-Am BOMBARDIER

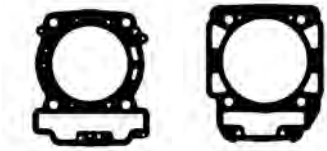

Head

Base

| Model | Year | Bore Size | EST Top End Kit | List Price | Component Part# | Component Description | List Price | OEM Part # |
|-----------------------------------|-------|-----------|--------------------|------------|--|----------------------------|------------|------------|
| Outlander STD, XT, MAX 1000 | 12-16 | 92mm | C3459-EST | \$155.00 | H2653018S | 92mm Head Gasket 2 Req. | \$44.55 | 420630195 |
| | | 93mm | C3460-EST | \$155.00 | H2653SP1018S | 93mm Head Gasket 2 Req. | \$44.55 | |
| | | 94mm | C3461-EST | \$155.00 | H2653SP2018S | 94mm Head Gasket 2 Req. | \$44.55 | |
| | | 96mm | C3462-EST | \$155.00 | H2653SP5018S | 95mm Head Gasket Req. | \$44.55 | |
| | | | | | 3186V | Valve Stem Seal 8 Required | \$4.99 | 420230515 |
| | | | | | R117V | Cam Chain Tensioner O-ring | \$1.19 | 420430370 |
| | | | | | R15X1.5V | Cam Adjuster O-ring | \$1.13 | 420250890 |
| | | | | | EX696 | Header Gasket 2 Required | \$10.28 | 707600317 |
| | | | | | B0895010RC | Base Gasket 2 Required | \$15.24 | 420630210 |
| | | | | | Bottom End Gaskets Available Separately | | | |
| | | | | | EC1652020F | Center Case Gasket | \$28.34 | 420651225 |
| | | | | | EC1651020F | PTO Cover Gasket | \$13.99 | 420651211 |
| | | | | | EC1171032AFM | Magneto Cover Gasket | \$16.98 | 420651200 |

COBRA

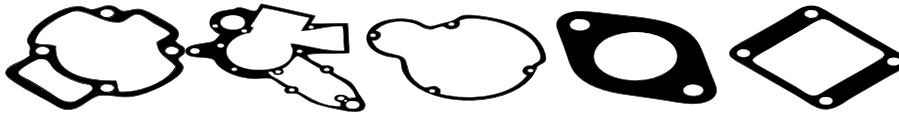

Base

Center Case

Ignition Cover

Exhaust

Intake

| Model | Year | Bore Size | Top End Kit | List Price | Component Part# | Component Description | List Price | OEM Part # | | | |
|--------------------------|-------|-----------|--------------|--------------------------|-----------------|---|-------------------|------------------------|------------------------------|-------------------|-------------------|
| KING 50 | 1998 | O-RING | C3254 | \$19.41 | R010V | Head Cover O-rings 4 req. | \$0.40 | ZCMUOR03 | | | |
| | | | | | R033B | Inner Head O-ring | \$2.86 | ZCMUOR05 | | | |
| | | | | | R105X2B | Outer Head O-ring | \$2.57 | ZCMUOR02 | | | |
| | | | | | B0848018AFM | Base Gasket | \$8.17 | ZCKG0002 | | | |
| | | | | | B0848012F | High Compression Base | \$7.10 | | | | |
| | | | | | EX916059F | Exhaust Gasket | \$3.93 | XCKG0001 | | | |
| | | | | | | Bottom End Kit w/o crank seals | List Price | Component Part# | Component Description | List Price | OEM Part # |
| | | | | | | C3307 | \$29.22 | EC1220060AFM | Clutch Cover Gasket | \$13.57 | ZCMU0030 |
| | | | | | | | | EC1301012F | Center Case Gasket | \$10.68 | ZCKG0012 |
| | | | | | | | | EC1302032AFM | Ignition Cover Gasket | \$8.69 | ZCKG0101 |
| | | | IR715032AFM | Intake Gasket | \$3.58 | ECMU0049 | | | | | |
| KING 50 W/2PC HEAD | 98-03 | O-RING | C3255 | \$19.41 | R010V | Head Cover O-rings 8 req. | \$0.40 | ECMU0049 | | | |
| | | | | | R033B | Inner Head O-ring | \$2.86 | ZCMUOR05 | | | |
| | | | | | R105X2B | Outer Head O-ring | \$2.57 | ZCMUOR02 | | | |
| | | | | | R121V | Head Cover Coolant Seal O-ring | \$1.25 | ZCMUOR08 | | | |
| | | | | | B0848018AFM | Base Gasket | \$8.17 | ZCMU0030 | | | |
| | | | | | B0848012F | High Compression Base | \$7.10 | ZCKG9902 | | | |
| | | | | | EX916059F | Exhaust Gasket | \$3.93 | ZCKG0101 | | | |
| | | | | | | Bottom End Kit w/o crank seals | List Price | Component Part# | Component Description | List Price | OEM Part # |
| | | | | | | C3308 | \$40.61 | EC1220060AFM | Clutch Cover Gasket | \$13.57 | ZCMU0030 |
| | | | | | | | | EC1301012F | 98 Center Case Gasket | \$10.68 | ZCKG0012 |
| | | | EC1304020F | 99-Up Center Case Gasket | \$14.25 | ZCKG9902 | | | | | |
| | | | EC1302032AFM | Ignition Cover Gasket | \$8.69 | ZCKG0101 | | | | | |
| | | | IR715032AFM | Intake Gasket | \$3.58 | ECMU0049 | | | | | |

All Component Parts can be purchased individually.



MX/Dirt · Off-Road · ATV Gaskets



Cometic Gasket - An Exclusive NASCAR Performance® Product

COBRA

| Model | Year | Bore Size | Top End Kit | List Price | Component Part# | Component Description | List Price | OEM Part # | | | | | |
|----------------------------------|-------|-----------|-------------|------------------------|----------------------------------|--------------------------------------|-------------------|-------------------|------------------------|--------------------|------------------------------|------------------|----------|
| CX50 | 13-15 | O-Ring | C3602 | \$36.18 | R105X2B | Outer Head O-ring | \$2.57 | ZCMUOR02 | | | | | |
| | | | | | R033B | Combustion Chamber O-ring | \$2.86 | ZCMUOR05 | | | | | |
| | | | | | R024V | Upper Dome O-ring | \$1.19 | ZCMUV024 | | | | | |
| | | | | | R010V | Stud O-rings 4 | \$0.40 | ZCMUOR10 | | | | | |
| | | | | | B0848031F | Base Gasket .031" | \$7.10 | ZCMU0708 | | | | | |
| | | | | | B0848020F | Base Gasket .020" | \$7.10 | ZCMU0705 | | | | | |
| | | | | | B0848015F | Base Gasket .015" | \$7.10 | ZCKG0501 | | | | | |
| | | | | | B0848012F | Base Gasket.012" | \$7.10 | ZCMU0703 | | | | | |
| | | | | | R026V | Exhaust Flange O-ring | \$1.19 | ZCMUOR07 | | | | | |
| | | | | | R125V | Header Flange O-ring 2 | \$1.19 | ZCMOTE11 | | | | | |
| | | | | | Bottom End Kit List Price | | | | Component Part# | Description | List Price | OEM Part# | |
| | | | | | | | | C3603 | \$37.27 | EC1982032AFM | Ignition Cover Gasket | \$8.69 | ZCCS0002 |
| | | | | | | | | | | EC1983020F | Crankcase Gasket | \$14.53 | ZCCS0005 |
| | | | | | | | | | | R018V | Sprocket Shaft Spacer O-ring | \$1.19 | ZCDCOR01 |
| | | | | | | | | | | WA116 | Drain Plug Gasket | \$1.06 | HCWC0000 |
| | | | | | EC1984060AFM | Clutch Cover Gasket | \$13.57 | ZCMU0030 | | | | | |
| | | | | | R12X2V | Kick Shaft O-ring | \$1.19 | ZCMUB014 | | | | | |
| | | | | | R12X2V | Oil Fil Plug O-ring | \$1.19 | ZCMUB014 | | | | | |
| CX65 | 13-14 | O-Ring | C3600 | \$54.99 | Component Part# | Component Description | List Price | OEM Part # | | | | | |
| | | | | | R010V | Cylinder Stud O-ring 5 | \$0.40 | ZCMUOR03 | | | | | |
| | | | | | R020V | Cylinder Dome Plug O-ring | \$1.19 | ZCMUOR23 | | | | | |
| | | | | | R033B | Combustion Chamber O-ring | \$2.86 | ZCMUOR05 | | | | | |
| | | | | | R88X2B | Outer Chamber O-ring | \$1.36 | ZCC60009 | | | | | |
| | | | | | R125V | Expansion Chamber to Flange O-ring 2 | \$1.19 | ZCMOTE11 | | | | | |
| | | | | | R126V | Pipe to flange O-ring | \$1.19 | ZCMUOR11 | | | | | |
| | | | | | R026V | Flange to Head O-ring | \$1.19 | ZCMUOR07 | | | | | |
| | | | | | B1106012F | Base Gasket .3mm .011" | \$10.88 | ZCC60303 | | | | | |
| | | | | | B1106015F | Base Gasket .4mm .015" | \$10.88 | ZCC60304 | | | | | |
| | | | | | B1106020F | Base Gasket .5mm .019" | \$10.88 | ZCC60305 | | | | | |
| | | | | | B1106031F | Base Gasket .8mm .031" | \$10.88 | ZCC60308 | | | | | |
| | | | | | PV148 | Power Valve Cover Gasket | \$2.97 | ZCC60012 | | | | | |
| | | | | | R122V | Power Valve Plunger O-ring | \$1.25 | ZCMUOR18 | | | | | |
| | | | | | R114V | Power Valve Solenoid Cap O-ring | \$1.19 | ZCMU0114 | | | | | |
| Bottom End Kit List Price | | | | Component Part# | Description | List Price | OEM Part# | | | | | | |
| | | | C3601 | \$52.25 | IR747018AFM | Intake Gasket | \$4.37 | ZCC60021 | | | | | |
| | | | | | R020V | Slave Cylinder Seal | \$1.19 | ZCMUOR25 | | | | | |
| | | | | | R105X3.5B | Clutch Cover O-ring | \$1.09 | ZCDCOR05 | | | | | |
| | | | | | R12X2V | Fill Plug O-ring | \$1.19 | ZCMUB014 | | | | | |
| | | | | | EC1985032AFM | Inner Clutch/Kick Cover Gasket | \$13.57 | ZCC60007 | | | | | |
| | | | | | R12X2V | Drain Plug O-ring | \$1.19 | ZCMUB014 | | | | | |
| | | | | | R018V | Output Shaft O-ring | \$1.19 | ZCMUOR21 | | | | | |
| | | | | | EC1673015F | Center Case Gasket | \$34.27 | ZCC60008 | | | | | |



MX/Dirt · Off-Road · ATV Gaskets



Cometic Gasket - An Exclusive NASCAR Performance® Product

GAS GAS

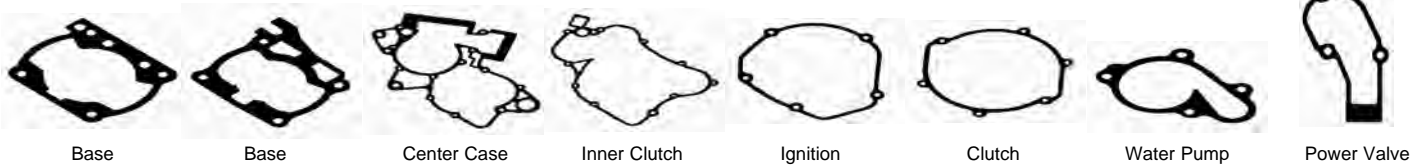

| Model | Year | Bore Size | Top End Kit | List Price | Component Part# | Component Description | List Price | OEM Part # | | | |
|---|--|-----------|-------------|-----------------------|-----------------|---|-------------------|------------------------|------------------------------|-------------------|------------------|
| 125 EC, XC, DE, MC | 01-11 | O-RING | C3260 | \$38.33 | B0537020F | Base Gasket | \$5.34 | ME120144000 | | | |
| | | | | | IR271020F | Intake Gasket | \$9.94 | ME120644005 | | | |
| | | | | | PV106020F | Center Power Valve Gasket | \$3.80 | ME120144006 | | | |
| | | | | | PV107039F | Right Side Power Valve Gasket | \$3.80 | ME120144007 | | | |
| | | | | | R63X2V | Inner Head O-ring | \$4.57 | ME120116065 | | | |
| | | | | | R90X2V | Outer Head O-ring | \$7.50 | ME120116060 | | | |
| | | | | | WA135 | Head Seal Washers 8 req. | \$0.80 | T4008516 | | | |
| | | | | | | Bottom End Kit w/o crank seals | List Price | Component Part# | Component Description | List Price | OEM Part# |
| | | | | | | C3309 | \$47.99 | EC561020F | Center Case Gasket | \$16.13 | ME120144001 |
| | | | | | | | | EC562032AFM | Inner Clutch Cover Gasket | \$16.13 | ME120144002 |
| | | | EC563020F | Ignition Cover Gasket | \$6.71 | ME120144004 | | | | | |
| | | | EC564031F | Clutch Cover Gasket | \$6.71 | ME120144004 | | | | | |
| | | | WP125020F | Water Pump Gasket | \$4.94 | ME120144008 | | | | | |
| 200/250/300 EC/MC/SM XC, EC200 XC, EC250 XC, EC300 EC200, DE200, EC200 Hobby, EC250, EC250 Race, DE250, MC250, EC300, DE300 | 98-UP 01-03 01-03 01-03 04-11 05-06 | O-RING | C3261 | \$45.99 | R045V | Outer Head O-Ring 200 | \$2.97 | M01619135 | | | |
| | | | | | B0403020F | Base Gasket | \$6.58 | ME25644000 | | | |
| | | | | | IR123032AFM | Intake Gasket | \$2.84 | 25644005 | | | |
| | | | | | PV089020F | Left Side Power Valve Gasket | \$4.65 | ME25644006 | | | |
| | | | | | PV090039F | Right Side Power Valve Gasket | \$1.99 | ME25644007 | | | |
| | | | | | | Right Power Valve Gasket | | ME25610002 | | | |
| | | | | | B0403015F | Base Gasket .38mm | \$6.58 | ME25644009 | | | |
| | | | | | B0403012F | Base Gasket .30mm | \$6.58 | ME25644010 | | | |
| | | | | | EX245043F | Exhaust Gasket | \$5.00 | ME25644012 | | | |
| | | | | | R046V | Outer Head O-Ring 250-300 | \$1.19 | ME25916060 | | | |
| | | | | | R040V | Inner Head O-Ring 200-250 | \$1.19 | ME25916065 | | | |
| | | | | | EC350031F | Thermostat Gasket | \$5.00 | ME25944011 | | | |
| | | | | | R041V | Inner Head O-Ring 300 | \$5.30 | ME30916065 | | | |
| | | | | | WA135 | Head Seal Washers 6 req. | \$0.80 | T4008516 | | | |
| | | | | | | Bottom End Kit w/o crank seals | List Price | Component Part# | Component Description | List Price | OEM Part# |
| | | | | | | C3310 | \$52.15 | EC345039F | Outer Clutch Cover Gasket | \$9.94 | ME25644003 |
| | | | | | | | | EC346031F | Mag Cover Gasket | \$8.69 | ME25644004 |
| | | | | | | | | EC348020F | Inner Clutch Cover | \$9.94 | ME25644002 |
| | | | EC349020F | Center Case Gasket | \$11.18 | ME25644001 | | | | | |
| | | | EC349031F | Center Case Gasket | \$11.18 | ME25644001 | | | | | |
| | | | R44X3S | Crank O-ring | \$2.82 | ME250112011 | | | | | |
| | | | WP082020F | Water Pump Gasket | \$2.38 | ME25644008 | | | | | |



MX/Dirt · Off-Road · ATV Gaskets



Cometic Gasket - An Exclusive NASCAR Performance® Product

GAS GAS

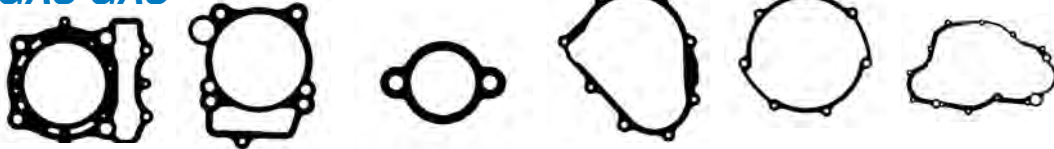

| Head | | Base | Cam Chain Tensioner | Mag Cover | Outer Clutch Cover | Inner Clutch Cover | | |
|------------------------|-------|-----------|---------------------------------------|------------|------------------------|----------------------------------|-------------------|-------------------------|
| Model | Year | Bore Size | EST | List Price | Component Part# | Component Description | List Price | OEM Part # |
| EC250F Yamaha Motor | 10-11 | 77 mm | C7905-EST | \$65.95 | H1168SP3027S | Head Gasket | \$41.72 | 5NL-11181-00-00 |
| | | 79 mm | C3057-EST | \$65.95 | H1168SP2027S | Head Gasket 79mm Bore | \$41.72 | |
| | | 81 mm | C3059-EST | \$65.95 | H1271027S | Head Gasket 81mm Bore | \$41.72 | |
| | | 83 mm | C3061-EST | \$65.95 | H1272SP3027S | Head Gasket 84mm Bore | \$41.72 | |
| | | 84 mm | C3120-EST | \$65.95 | B0503020RC | Base Gasket | \$20.25 | 5NL-11351-00-00 |
| | | | | | EX651 | Exhaust Gasket | \$8.98 | 5NL-14613-00-00 |
| | | | | | EC019032AFM | Cam Chain Tensioner Gasket | \$1.96 | 4FM-12213-00 |
| | | | | | 3179V | Exhaust Valve Seal 2 Req. | \$5.50 ea. | 4SV-12119-00-00 |
| | | | | | 3233 | VIntake Valve Seal 3 Req. | \$5.11 ea. | 4TV-12119-00-00 |
| | | | | | | | | |
| | | | Bottom End Kit w/Oil Seals | | | | | |
| | | | C3057BE | \$74.14 | EC554032AFM | Inner Clutch Cover Gasket | \$9.94 | 5NL-15462-00-00 |
| | | | | | R011B | Oil Delivery O-ring (SM) | \$1.08 | 93210-07003-00/07540-00 |
| | | | | | R013B | Oil Pump Seal O-Ring | \$1.19 | 93210-10197-00* |
| | | | | | R013B | Clutch Side Oil Feed Line O-Ring | \$1.19 | 93210-10197-00* |
| | | | | | R013B | Mag Side Oil Feed Line O-Ring | \$1.19 | 93210-10197-00* |
| | | | | | R014B | Oil Delivery Pipe O-Ring (Lg.) | \$1.08 | 93210-12759-00 |
| | | | | | R016V | Case Dowel O-ring | \$1.19 | 93210-16772-00 |
| | | | | | R109B | Oil Filter Cover O-Ring (Sm.) | \$1.13 | 93210-07135-00 |
| | | | | | R10X2V | Centercase Dowel O-ring | \$1.59 | 93210-10197-00* |
| | | | | | R113B | Timing Plug O-ring | \$1.19 | 93210-14369-00 |
| | | | | | R124B | Crank End Plug O-ring | \$3.92 | 93210-32172-00 |
| | | | | | R134B | Oil Filter O-Ring (LG) | \$1.13 | 93210-47675-00 |
| | | | | | R19X2V | Oil Fill Plug O-ring | \$2.50 | 93210-19123-00 |
| | | | | | R903V | Oil Delivery Pipe O-ring (Med.) | \$1.19 | 93210-09008-00 |
| | | | | | WA080043C | Coolant Drain Bolt Washer | \$0.57 | 90430-06014-00* |
| | | | | | WA082063C | Oil Drain Bolt Washer | \$1.93 | 90430-10188-00*/ |
| | | | | | Component Part# | Component Description | List Price | OEM Part# |
| | | | | | VC103 | Valve Cover Gasket | \$17.80 | |

HONDA CRF50/70



| Head | | Base | Clutch | Right Engine Cover | Left Engine Cover | Front Engine Cover | Exhaust | Head |
|-------|-------|-----------|-------------|---------------------|------------------------|-------------------------------|-------------------|------------------|
| Model | Year | Bore Size | EST | List Price | Component Part# | Component Description | List Price | OEM Part # |
| CRF50 | 04-16 | 39 mm | C7974-EST | \$57.15 | H1820040S | Head Gasket 39mm Bore | \$20.75 | 12251-GBJ-003 |
| XR50 | 88-03 | 41 mm | C7975-EST | \$57.15 | H1821040S | Head Gasket 41mm Bore | \$20.75 | |
| Z50R | 82-87 | | | | B0659020F | Base Gasket | \$7.16 | 12191-GW8-681 |
| | | | | | 3234V | Valve Stem Seals 2 Req. | \$5.50 ea. | 12209-GB4-681 |
| | | | | | EC1070018AFM | Right Side Head Cover Gasket | \$2.33 | 12394-GW8-680 |
| | | | | | EC1071018AFM | Left Side Head Cover Gasket | \$2.33 | 12395-GW8-680 |
| | | | | | EC1072018AFM | Center Head Cover Gasket | \$4.72 | 12391-GW8-680 |
| | | | | | EX690064AM | Exhaust Gasket | \$2.56 | 18291-HB2-900 |
| | | | | | R018B | Intake Runner O-Ring to Carb. | \$3.92 | 91302-001-020 |
| | | | | | R14X2.5V | Dowel Pin O-Ring | \$1.13 | 91301-GB0-911 |
| | | | | | R16X2V | Dowel Pin O-Ring | \$3.02 | 91303-035-000 |
| | | | | | R219V | Valve Adjustment Cap 2 Req. | \$3.92 | 91302-001-020 |
| | | | | | R27X2V | Intake Runner O-Ring to Head | \$1.86 | 91301-GK4-871 |
| | | | | | R9X2V | Valve Guide Seals 2 Req. | \$1.59 | 91305-028-158 |
| | | | | | Component Part# | Component Description | List Price | OEM Part# |
| | | | EC901032AFM | Clutch Cover Gasket | \$14.71 | 11394-GW8-680 | | |



MX/Dirt • Off-Road • ATV Gaskets



Cometic Gasket - An Exclusive NASCAR Performance® Product

HONDA

| Model | Year | Bore Size | Top End Kit | List Price | Component Part# | Component Description | List Price | OEM Part # |
|-------|-------|-----------|------------------------|-------------------|------------------------|-------------------------------|-------------------|-------------------|
| ATC70 | 78-85 | 49 mm | C7228 | | H0326043F | Head Gasket | \$20.99 | 12251-111-505 |
| TRX70 | 86-87 | 49 mm | | | B0193020F | Base Gasket | \$7.16 | 12191-GW8-681 |
| | | | | | Component Part# | Component Description | List Price | OEM Part # |
| | | | | | EC901032AFM | Clutch Side Engine Cover | \$14.71 | 11394-GW8-680 |
| | | | EST Top End Kit | List Price | Component Part# | Component Description | List Price | OEM Part # |
| XR70R | 97-03 | 50 mm | C7300-EST | \$62.41 | H2712040S | Head Gasket 50mm Bore | \$24.75 | 12200-GB5-931 |
| CRF70 | 04-12 | | | | B0659020F | Base Gasket | \$7.16 | 12191-GW8-681 |
| | | | | | 3234V | Valve Stem Seals 2 Req. | \$5.50 ea. | 12209-GB4-681 |
| | | | | | EC1070018AFM | Right Side Head Cover Gasket | \$2.33 | 12394-GW8-680 |
| | | | | | EC1071018AFM | Left Side Head Cover Gasket | \$2.33 | 12395-GW8-680 |
| | | | | | EC1072018AFM | Center Head Cover Gasket | \$4.72 | 12391-GW8-680 |
| | | | | | EX690064AM | Exhaust Gasket | \$2.56 | 18291-HB2-900 |
| | | | | | R018B | Intake Runner O-Ring to Carb. | \$3.92 | 91302-001-020 |
| | | | | | R14X2.5V | Dowel Pin O-Ring | \$1.13 | 91301-GB0-911 |
| | | | | | R16X2V | Dowel Pin O-Ring | \$3.02 | 91303-035-000 |
| | | | | | R219V | Valve Adjustment Cap 2 Req. | \$3.92 | 91302-001-020 |
| | | | | | Component Part# | Component Description | List Price | OEM Part # |
| | | | | | EC901032AFM | Clutch Side Engine Cover | \$14.71 | 11394-GW8-680 |

CR80

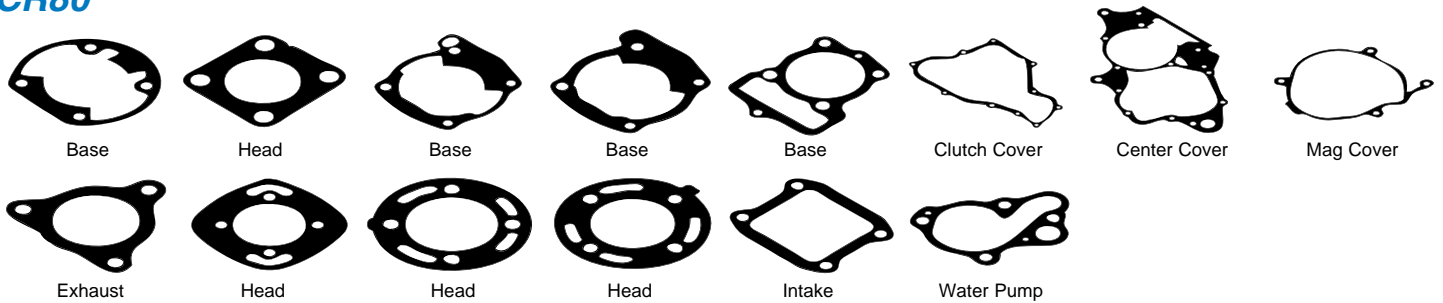

| Model | Year | Bore Size | Top End Kit | List Price | Component Part# | Component Description | List Price | OEM Part # |
|-------|-------|-----------|-----------------------|-------------------|------------------------|------------------------------|-------------------|-------------------|
| CR80 | 80-82 | 51.5 mm | C7334 | \$21.99 | H0469020C | Head Gasket | \$17.15 | 12251-169-000 |
| TC80 | 70-78 | | | | B0277020F | Base Gasket | \$4.65 | 12191-GC4-306 |
| | | | Top End Kit | List Price | Component Part# | Component Description | List Price | OEM Part # |
| CR80 | 83 | 51.5 mm | C7000 | \$21.99 | H0001020C | Head Gasket | \$17.15 | 12251-GC4-307 |
| | | | | | B0001020F | Base Gasket | \$4.65 | 12191-GC4-700 |
| | | | Crank Seal Kit | List Price | Kit Components | Component Description | List Price | OEM Part# |
| | | | C7653 | \$16.58 | OS103 | 20X32X7 Left Side Oil Seal | \$9.47 | 91205-166-004 |
| | | | | | OS104 | 22X40X8 Right Side Oil Seal | \$7.10 | 91206-GC4-711 |
| | | | Top End Kit | List Price | Component Part# | Component Description | List Price | OEM Part # |
| CR80 | 84 | 51.5 mm | C7001 | \$21.99 | H0001020C | Head Gasket | \$17.15 | 12251-GC4-307 |
| | | | | | B0002020F | Base Gasket | \$4.65 | 12191-GC4-700 |
| | | | Crank Seal Kit | List Price | Kit Components | Component Description | List Price | OEM Part# |
| | | | C7653 | \$16.58 | OS103 | 20X32X7 Left Side Oil Seal | \$9.47 | 91205-166-004 |
| | | | | | OS104 | 22X40X8 Right Side Oil Seal | \$7.10 | 91206-GC4-711 |
| | | | Top End Kit | List Price | Component Part# | Component Description | List Price | OEM Part # |
| CR80 | 85 | 49 mm | C7002 | \$19.14 | H0002043F | Head Gasket | \$14.87 | 12251-GC4-307 |
| | | | | | B0003020F | Base Gasket | \$4.65 | 12191-GC4-308 |
| | | | Crank Seal Kit | List Price | Kit Components | Component Description | List Price | OEM Part# |
| | | | C7653 | \$16.58 | OS103 | 20X32X7 Left Side Oil Seal | \$9.47 | 91205-166-004 |
| | | | | | OS104 | 22X40X8 Right Side Oil Seal | \$7.10 | 91206-GC4-711 |



MX/Dirt · Off-Road · ATV Gaskets



Cometic Gasket - An Exclusive NASCAR Performance® Product

CR80 86-02 / CR85 03-07

| Model | Year | Bore Size | Top End Kit | List Price | Component Part# | Component Description | List Price | OEM Part # |
|------------|-------|-----------|-----------------------------------|-------------------|------------------------|-------------------------------|-------------------|-------------------|
| CR80 | 86-91 | 48 mm | C7003 | \$26.80 | H0003043F | Head Gasket | \$14.87 | 12251-GS2-781 |
| | | | | | B0003020F | Base Gasket | \$4.65 | 12191-GC4-308 |
| | | | | | EX002042AM | Exhaust Gasket | \$4.65 | 18291-GC4-600 |
| | | | | | IR001018AFM | Intake Gasket | \$3.80 | 14132-904-600 |
| | | | Crank Seal Kit | List Price | Kit Components | Component Description | List Price | OEM Part# |
| | | | C7653 | \$16.58 | OS103 | 20X32X7 Left Side Oil Seal | \$9.47 | 91205-166-004 |
| | | | | | OS104 | 22X40X8 Right Side Oil Seal | \$7.10 | 91206-GC4-711 |
| | | | Top End Kit | List Price | Component Part# | Component Description | List Price | OEM Part # |
| CR80 | 92-02 | 48 mm | C7126 | \$26.80 | H0266010S | Head Gasket 48mm Bore | \$16.75 | 12251-GS2-621 |
| CR80Expert | 96-02 | 49 mm | C7305 | \$26.80 | H0440010S | Head Gasket 49mm Bore | \$16.75 | |
| CR85 | 03-07 | 51 mm | C7932 | \$26.80 | H1698010S | Head Gasket 51mm Bore | \$16.75 | |
| | | 52 mm | C7315 | \$26.80 | H0449010S | Head Gasket 52mm Bore | \$16.75 | |
| | | | | | B0004018AFM | Base Gasket | \$9.32 | 12191-GBF-830 |
| | | | | | B0004012F | Base Gasket High Compression | \$9.32 | 12191-GBF-830 |
| | | | | | EX002042AM | Exhaust Gasket | \$4.65 | 18291-GC4-600 |
| | | | | | IR001018AFM | Intake Gasket | \$3.80 | 14132-904-600 |
| | | | | | R38X3V | Exhaust O-rings 03-Up | \$3.79 | 91304-GBF-K41 |
| | | | | | WA138 | Exhaust Washer 03-Up | \$1.02 | 18309-GBF-K40 |
| | | | Bottom End Kit w/Oil Seals | List Price | Component Part# | Component Description | List Price | OEM Part # |
| | | | C7126BE | \$62.29 | EC183020F | Center Case Gasket | \$14.87 | 11191-GBF-830 |
| | | | | | WP03200032AFM | Water Pump Gasket | \$3.74 | 19229-GBF-840 |
| | | | | | WA133 | Water Pump Drain Washer | \$0.90 | 90543-273-000 |
| | | | | | WA137 | Drain Plug Washer | \$1.53 | 90407-259-000 |
| | | | | | R12X2.5B | Oil Fill Plug O-ring 11.9x2.2 | \$4.09 | 91370-461-000 |
| | | | Oil Seal Kit | List Price | Component Part# | Component Description | List Price | OEM Part # |
| | | | C7126OS | \$35.07 | OS103 | Crank Seal 20x32x7 | \$9.47 | 91205-GC4-711 |
| | | | | | OS104 | Crank Seal 22x40x8 | \$7.10 | 91206-GC4-711 |
| | | | | | OS197 | Shift Shaft Seal 14x24x6 | \$2.46 | 91202-444-023 |
| | | | | | OS203 | Output Shaft Seal 17x28x7 | \$3.26 | 91201-415-013 |
| | | | | | OS242 | Water Pump Shaft Seal 12x25x7 | \$2.67 | 91211-KA3-761 |
| | | | | | OS245 | Start Shaft Seal 15x25x6 | \$3.94 | 91211-671-003 |
| | | | | | OS246 | Impeller Shaft Seal 12x21x5 | \$2.86 | 91201-035-015 |
| | | | | | OS247 | Clutch Actuator Seal 12x18x5 | \$3.31 | 91204-KKO-003 |
| | | | Clutch & Mag Kit | List Price | Component Part# | Component Description | List Price | OEM Part # |
| | | | C7126CM | \$11.18 | EC1820032AFM | Clutch Cover Gasket | \$7.44 | 11393-GBF-830 |

XL80/100



Base Base Head Head Right Case Cover Head Intake

| Model | Year | Bore Size | Top End Kit | List Price | Component Part# | Component Description | List Price | OEM Part # |
|-----------|-------|-----------|------------------------|-------------------|------------------------|------------------------------|-------------------|-------------------|
| XL80 | 80-85 | 50 mm | C7230 | \$21.76 | H0336043F | Head Gasket 50mm Bore | \$18.56 | 12251-GN1-880 |
| XR80 | 79-84 | | | | B0192020F | Base Gasket | \$8.69 | 12191-GN1-730 |
| XR80R | 85-91 | | | | | | | |
| XR80Z A/B | 79-81 | | | | | | | |
| | | | EST Top End Kit | List Price | Component Part# | Component Description | List Price | OEM Part # |
| CRF80F | 04-13 | 54 mm | C7231-EST | \$54.80 | H2598010S | Head Gasket 50mm Bore | \$13.74 | 12251-GN1-A41 |
| XR80R | 92-03 | | | | 3231V | Valve Stem Seals 2 req. | \$6.48 ea. | 12208-413-003 |
| | | | | | B0192020RC | Base Gasket | \$8.69 | 12191-GN1-730 |
| | | | | | IR575032AFM | Intake Gasket | \$4.77 | 16229-GN1-A41 |
| | | | | | R10X2V | Valve Guide O-rings 2 req. | \$1.59 | 91301-200-000 |
| | | | | | EX784080C | Exhaust Gasket | \$3.35 | 18291-KZ1-670 |
| | | | | | Component Part# | Component Description | List Price | OEM Part # |
| | | | | | EC1074018AFM | Clutch Cover Gasket | \$2.38 | 11393-KN4-750 |



MX/Dirt · Off-Road · ATV Gaskets



Cometic Gasket - An Exclusive NASCAR Performance® Product

HONDA TRX90

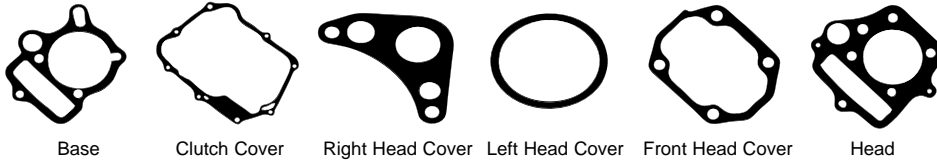

| Model | Year | Bore Size | EST Top End Kit | List Price | Component Part# | Component Description | List Price | OEM Part # |
|--------|-------|-----------|---|------------------------------|--|--|------------------------------|------------------------------------|
| TRX90 | 93-16 | 50 mm | C7226-EST | \$71.49 | H2710040S | Head Gasket | \$24.75 | 12251-GB5-811 |
| | | | | | B0659020RC | Base Gasket | \$7.16 | 12191-GW8-681 |
| | | | | | 3234V | Valve Stem Seals 2 Req. | \$5.50 ea. | 12209-GB4-681 |
| | | | | | EC1070018AFM | Right Head Cover | \$2.33 | 12394-GW8-680 |
| | | | | | EC1071018AFM | Left Head Cover | \$2.33 | 12395-GW8-680 |
| | | | | | EC1072018AFM | Center Head Cover | \$4.72 | 12391-GW8-680 |
| | | | | | R027B | Valve Cap O-rings 2 Req. | \$0.74 | 91302-001-020 |
| | | | | | R14X2.5V | Oil Return O-ring | \$1.13 | 91301-GF6-003 |
| | | | | | R16X2V | Base O-ring | \$3.02 | 91303-035-000 |
| | | | | | R9X2V | Valve Guide O-rings 2 Req. | \$1.59 | 91305-028-900 |
| | | | | | Component Part# EC901032AFM | Component Description Clutch Side Engine Cover | List Price \$14.71 | OEM Part # 11394-GW8-680 |
| XL100 | 79-85 | 55 mm | Top End Kit C7988 | List Price \$26.80 | Component Part# H0329040S | Component Description Head Gasket 55mm Bore | List Price \$20.75 | OEM Part # 12251-KA8-405 |
| XR100 | 81-91 | 58 mm | C7985 | \$26.80 | H0329SP1040S | Head Gasket 58mm Bore | \$20.75 | 12251-KA8-405 |
| | | | | | B0194020F | Base Gasket | \$13.69 | 12191-KN4-750 |
| CRF100 | 04-13 | 55 mm | EST Top End Kit C7989-EST | List Price \$65.53 | Component Part# H0330010S | Component Description Head Gasket 55mm Bore | List Price \$24.75 | OEM Part # 12251-KN4-751 |
| XR100 | 92-03 | 58 mm | C7986-EST | \$65.53 | H0330SP1010S | Head Gasket 58mm Bore | \$24.75 | 12208-413-003 |
| | | | | | 3231V | Valve Stem Seals 2 req. | \$6.48 ea. | 12191-KN4-750 |
| | | | | | B0194020F | Base Gasket | \$7.16 | 16229-GN1-A41 |
| | | | | | IR575032AFM | Intake Gasket | \$4.77 | 91301-200-000 |
| | | | | | R10X2V | Valve Guide O-rings 2 req. | \$1.59 | 91302-401-000 |
| | | | | | R30X3.5B | Intake O-ring | \$3.43 | |
| | | | | | Component Part# EC1074018AFM | Component Description Clutch Cover Gasket | List Price \$2.38 | OEM Part # 11393-KN4-750 |

CR125

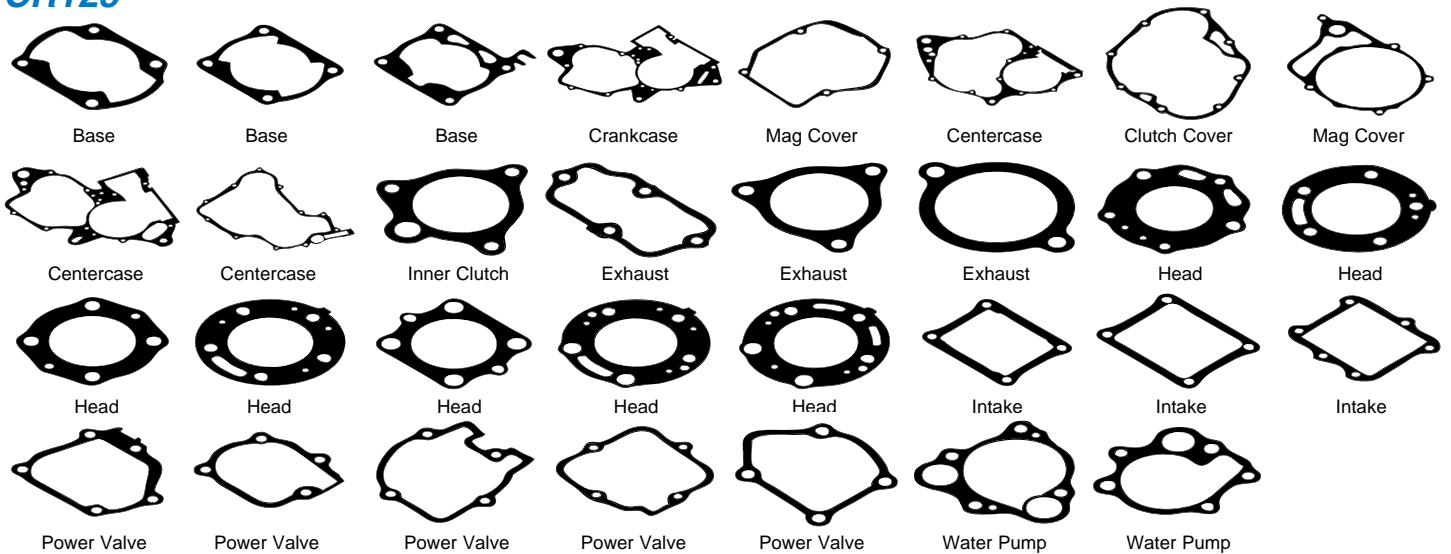

All Component Parts can be purchased individually.



MX/Dirt • Off-Road • ATV Gaskets



Cometic Gasket - An Exclusive NASCAR Performance® Product

HONDA

| Model | Year | Bore Size | Top End Kit | List Price | Component Part# | Component Description | List Price | OEM Part # |
|----------------|-------|-----------|--|-----------------------|--|---|---|--|
| CR125 MT125 | 73-78 | 58 mm | C7465 | \$30.84 | H0216020C B0345020F | Head Gasket 58mm Bore Base Gasket | \$24.24 \$6.25 | 12251-360-000 12191-373-306 |
| CR125 | 79-80 | 57.7 mm | C7466 | \$26.80 | H0739020C B0351020F EX419043F IR214060AFM IR215060AFM | Head Gasket 57.7mm Bore Base Gasket Exhaust Gasket Intake Gasket Reed to Case Intake Gasket Reed to Carb Boot | \$24.24 \$6.25 \$4.77 \$5.63 \$5.63 | 12251-466-000 12191-444-306 18291-444-306 14132-444-306 14131-444-306 |
| | | | Bottom End Kit w/o crank seals C3312 | List Price \$35.35 | Component Part# EC533020F EC534020F EC670060AFM | Component Description Center Case Gasket Clutch Cover Gasket Mag Cover Gasket | List Price \$14.87 \$13.97 \$14.87 | OEM Part # 11191-444-306 11394-444-306 11395-444-306 |
| CR125 | 81 | 56 mm | C3168 | \$31.68 | H1902043F B0351018AFM EX419043F IR214060AFM IR215060AFM | Head Gasket 56mm Bore Base Gasket Exhaust Gasket Intake Gasket Reed to Case Intake Gasket Reed to Carb Boot | \$17.83 \$6.25 \$4.77 \$5.63 \$5.63 | 12251-KA3-306 12191-444-306 18291-444-306 14132-444-306 14131-444-306 |
| CR125 | 82 | 56 mm | C3430 | \$35.72 | H1715043F B0351018AFM EX419043F IR214060AFM IR215060AFM EX419043F | Head Gasket 56mm Bore Base Gasket Exhaust Gasket Intake Gasket Reed to Case Intake Gasket Reed to Carb Boot Exhaust Gasket | \$17.38 \$6.25 \$4.77 \$5.63 \$5.63 \$4.77 | 12251-KA3-307 12191-444-306 18291-444-306 14132-444-306 14131-444-306 18291-444-306 |
| CR125 | 83 | 57 mm | C7118 | \$21.76 | H0004043F B0005020F | Head Gasket 57mm Bore Base Gasket | \$17.38 \$5.34 | 12251-KA3-308 12191-KA3-306 |
| CR125 | 84-85 | 57 mm | C7005 | \$31.91 | H0004043F B0006020F EX003042AM IR002020F IR003018AFM | Head Gasket 57mm Bore Base Gasket Exhaust Gasket Intake Gasket Reed to Case Intake Gasket Reed to Carb Boot | \$17.38 \$5.34 \$4.65 \$3.80 \$3.80 | 12251-KA3-308 12191-KA3-740 18359-K56-000 14131-KA3-710 14132-K56-701 |
| CR125 | 86 | 56 mm | C7006 | \$31.91 | H0005043F B0007020F EX003042AM IR003018AFM | Head Gasket 56mm Bore Base Gasket Exhaust Gasket Int. Gasket Reed to Carb Boot | \$17.38 \$5.34 \$4.65 \$3.80 | 12251-KS6-405 12191-KA3-307 18359-K56-000 14132-K56-701 |
| CR125 | 87 | 56 mm | C7007 | \$35.72 | H0006043F B0008020F EX004042AM EX005031F IR003018AFM | Head Gasket 56mm Bore Base Gasket Exhaust Gasket Exhaust Gasket Intake Gasket Reed to Carb Boot | \$17.38 \$5.34 \$4.65 \$4.65 \$3.80 | 12251-KZ4-701 12191-KS6-701 18314-K56-701 18339-K56-701 14132-K56-701 |
| | | | | | Component Part# C7491 | Component Description Clutch Cover Gasket | List Price \$12.78 | OEM Part # 91311-KS6-700 |
| | | | Crank Seal Kit C7654 | List Price \$17.04 | Kit Components OS103 OS105 | Component Description 20X32X7 Left Side Crank Seal 30X45X8 Right Side Crank Seal | List Price \$9.47 \$9.47 | OEM Part# 91205-166-004 91203-KS6-004 |



MX/Dirt · Off-Road · ATV Gaskets



Cometic Gasket - An Exclusive NASCAR Performance® Product

HONDA

| Model | Year | Bore Size | Top End Kit | List Price | Component Part# | Component Description | List Price | OEM Part # | | | | |
|-------|-------|-----------------------|---------------------------------|-------------|--------------------------------|--------------------------------|---------------------------------|-------------------|------------------------|------------------------------|-------------------|------------------------------|
| CR125 | 88-89 | 56 mm | C7008 | \$35.72 | H0355010S | Head Gasket 56mm Bore | \$17.38 | 12251-KZ4-701 | | | | |
| | | | | | B0008020F | Base Gasket | \$5.34 | 12191-KS6-701 | | | | |
| | | | | | EX004042AM | Exhaust Gasket | \$4.65 | 18314-K56-701 | | | | |
| | | | | | EX005031F | Exhaust Gasket | \$4.65 | 18339-K56-701 | | | | |
| | | | | | IR003018AFM | Int. Gasket Reed to Carb Boot | \$3.80 | 14132-K56-701 | | | | |
| | | | | | Component Part# | Component Description | List Price | OEM Part # | | | | |
| | | | | | C7491 | Clutch Cover Gasket | \$12.78 | 91311-KS6-700 | | | | |
| | | | | | Kit Components | Component Description | List Price | OEM Part# | | | | |
| | | | | | OS103 | 20X32X7 Left Side Crank Seal | \$9.47 | 91205-166-004 | | | | |
| | | | | | OS105 | 30X45X8 Right Side Crank Seal | \$9.47 | 91203-KS6-004 | | | | |
| | | Crank Seal Kit | List Price | | | | | | | | | |
| | | C7654 | \$17.04 | | | | | | | | | |
| CR125 | 90-91 | 55 mm | C7010 | \$35.72 | H0225010S | Head Gasket 55mm Bore | \$17.38 | 12251-KZ4-701 | | | | |
| | | | | | B0009018AFM | Base Gasket | \$5.34 | 12191-KZ4-860 | | | | |
| | | | | | EX006042AM | Exhaust Gasket | \$4.65 | 18291-KZ4-700 | | | | |
| | | | | | IR003018AFM | Int. Gasket Reed to Carb Boot | \$3.80 | 14132-K56-701 | | | | |
| | | | | | PV001018AFM | Right Power Valve Cover Gasket | \$3.80 | 12108-KZ4-700 | | | | |
| | | | | | PV002018AFM | Left Power Valve Cover Gasket | \$3.80 | 12109-KZ4-700 | | | | |
| | | | | | PV003018AFM | Upper Power Valve Cover Gasket | \$3.80 | 12112-KZ4-700 | | | | |
| | | | | | | | Top End Kit | List Price | Component Part# | Component Description | List Price | OEM Part # |
| | | | | | | | C7115 | \$35.72 | H0225010S | Head Gasket 55mm Bore | \$17.38 | 12251-KZ4-701 |
| | | | | | | | C7306 | \$35.72 | H0355010S | Head Gasket 56mm Bore | \$17.38 | 12251-KZ4-701 |
| | | C7299 | \$35.72 | H0409010S | Head Gasket 58mm Bore | \$17.38 | 12251-KZ4-701 | | | | | |
| | | | | B0009018AFM | Base Gasket | \$5.34 | 12191-KZ4-860 | | | | | |
| | | | | B0009012F | High Compression Base Gasket | \$9.32 | 12191-KZ4-860 | | | | | |
| | | | | EX006042AM | Exhaust Gasket | \$4.65 | 18291-KZ4-700 | | | | | |
| | | | | IR003018AFM | Int. Gasket Reed to Carb Boot | \$3.80 | 14132-K56-701 | | | | | |
| | | | | PV001018AFM | Right Power Valve Cover Gasket | \$3.80 | 12108-KZ4-700 | | | | | |
| | | | | PV002018AFM | Left Power Valve Cover Gasket | \$3.80 | 12109-KZ4-700 | | | | | |
| | | | | PV003018AFM | Upper Power Valve Cover Gasket | \$3.80 | 12112-KZ4-700 | | | | | |
| CR125 | 92-97 | 55 mm | C7115 | \$35.72 | H0225010S | Head Gasket 55mm Bore | \$17.38 | 12251-KZ4-701 | | | | |
| | | | | | 56 mm | C7306 | \$35.72 | H0355010S | Head Gasket 56mm Bore | \$17.38 | 12251-KZ4-701 | |
| | | | | | | | | 58 mm | C7299 | \$35.72 | H0409010S | Head Gasket 58mm Bore |
| | | B0009018AFM | Base Gasket | \$5.34 | | | | | | | 12191-KZ4-860 | |
| | | B0009012F | High Compression Base Gasket | \$9.32 | 12191-KZ4-860 | | | | | | | |
| | | | | | | EX006042AM | Exhaust Gasket | \$4.65 | 18291-KZ4-700 | | | |
| | | | | | | IR003018AFM | Int. Gasket Reed to Carb Boot | \$3.80 | 14132-K56-701 | | | |
| | | | | | | PV001018AFM | Right Power Valve Cover Gasket | \$3.80 | 12108-KZ4-700 | | | |
| | | | | | | PV002018AFM | Left Power Valve Cover Gasket | \$3.80 | 12109-KZ4-700 | | | |
| | | | | | | PV003018AFM | Upper Power Valve Cover Gasket | \$3.80 | 12112-KZ4-700 | | | |
| | | | | | | | | | | | | |
| | | | | | | | | | | | | |
| CR125 | 98-99 | 55 mm | C7394 | \$35.74 | H0225010S | Head Gasket 55mm Bore | \$17.38 | 12251-KZ4-701 | | | | |
| | | | | | 56 mm | C7406 | \$35.74 | H0355010S | Head Gasket 56mm Bore | \$17.38 | 12251-KZ4-701 | |
| | | | | | | | | 58 mm | C7407 | \$35.74 | H0409010S | Head Gasket 58mm Bore |
| | | B0314018AFM | Base Gasket | \$5.34 | | | | | | | 12191-KZ4-J00 | |
| | | B0314012F | High compression Base Gasket | \$9.32 | 12191-KZ4-J00 | | | | | | | |
| | | | | | | IR003018AFM | Int. Gasket Reed to Carb Boot | \$3.80 | 14132-K56-701 | | | |
| | | | | | | EX006042AM | Exhaust Gasket | \$4.65 | 18291-KZ4-700 | | | |
| | | | | | | PV001018AFM | Right Power Valve Cover Gasket | \$3.80 | 12108-KZ4-700 | | | |
| | | | | | | PV002018AFM | Left Power Valve Cover Gasket | \$3.80 | 12109-KZ4-700 | | | |
| | | | | | | PV003018AFM | Upper Power Valve Cover Gasket | \$3.80 | 12112-KZ4-700 | | | |
| | | | | | | | | | | | | |
| CR125 | 00 | 54 mm | C7678 | \$42.13 | H0928010S | Head Gasket 54mm Bore | \$17.38 | 12251-KZ4-A91 | | | | |
| | | | | | 56 mm | C7694 | \$42.13 | H0929010S | Head Gasket 56mm Bore | \$17.38 | 12251-KZ4-A91 | |
| | | | | | | | | 58 mm | C7695 | \$42.13 | H0930010S | Head Gasket 58mm Bore |
| | | B0314018AFM | Base Gasket | \$5.34 | | | | | | | 12191-KZ4-J00 | |
| | | B0314012F | High compression Base Gasket | \$9.32 | 12191-KZ4-J00 | | | | | | | |
| | | | | | | B0314010S | High compression Base Gasket | \$9.32 | 12191-KZ4-J00 | | | |
| | | | | | | IR003018AFM | Intake Gasket Reed to Carb Boot | \$3.80 | 14132-K56-701 | | | |
| | | | | | | EX006042AM | Exhaust Gasket | \$4.65 | 18291-KZ4-700 | | | |
| | | | | | | PV091032AFM | Right Power Valve Cover Gasket | \$5.34 | 12108-KZ4-A90 | | | |
| | | | | | | | | | | | | |
| CR125 | 01-02 | 54 mm | C7757 | \$38.33 | H0928010S | Head Gasket 54mm Bore | \$17.38 | 12251-KZ4-A91 | | | | |
| | | | | | 56mm | C7758 | \$38.33 | B0490018AFM | Base Gasket | \$7.38 | 12191-KZ4-L10 | |
| | | | | | | | | 58mm | C7759 | \$38.33 | B0490012F | High Compression Base Gasket |
| | | EX006042AM | Exhaust Gasket | \$4.65 | | | | | | | 18291-KZ4-700 | |
| | | IR003018AFM | Intake Gasket Reed to Carb Boot | \$3.80 | 14132-K56-701 | | | | | | | |
| | | | | | | PV091032AFM | Right Power Valve Cover Gasket | \$5.34 | 12108-KZ4-A90 | | | |
| | | | | | | R124S | Expansion Cham O-rings 2 Req. | \$3.74 | | | | |
| | | | | | | R19X3V | Water Outlet O-ring | \$3.02 | 91312-KE7-003 | | | |



MX/Dirt • Off-Road • ATV Gaskets



Cometic Gasket - An Exclusive NASCAR Performance® Product

HONDA

| Model | Year | | Bottom End Kit w/Oil Seals | List Price | Component Part# | Component Description | List Price | OEM Part # | | |
|-------|-------|-------|-----------------------------|-------------------|-----------------------------------|---------------------------------|------------------------|------------------------------|-------------------|-------------------|
| CR125 | 90-02 | | C7010BE | \$66.70 | EC083032AFM | Inner Clutch Cover | \$6.71 | 11394-KZ4-A90 | | |
| | | | | | EC185020F | Center Case Gasket | \$16.13 | 11191-KZ4-620 | | |
| | | | | | IR003018AFM | Intake Gasket | \$3.80 | 14132-KY4-970 | | |
| | | | | | R16X3V | Fill Plug O-ring | \$1.26 | 91303-800-000 | | |
| | | | | | R20X2V | Output Shaft O-ring | \$3.02 | 91351-KA3-711 | | |
| | | | | | WA117 | Drain Plug Gasket | \$0.95 | 94109-12000 | | |
| | | | | | WA133 | Water Pump Drain Plug Gasket | \$0.90 | 90543-273-000 | | |
| | | | | | WP033018AFM | Water Pump Gasket 2 req | \$4.94 | 19229-KZ4-620 | | |
| | | | Oil Seal Kit | List Price | Component Part# | Component Description | List Price | OEM Part # | | |
| | | | C7010OS | \$36.50 | OS103 | Left Crank Seal | \$9.47 | 91205-166-004 | | |
| | | | | | OS105 | Right Crank Seal | \$9.47 | 91203-KS6-004 | | |
| | | | | | OS227 | Water Pump Shaft Seal | \$2.67 | 91201-965-000 | | |
| | | | | | OS236 | Shift Shaft Seal | \$4.23 | 91203-KK3-830 | | |
| | | | | | OS242 | Outer Water Pump Shaft Seal | \$2.67 | 91211-KA3-761 | | |
| | | | | | OS243 | Start Shaft Seal | \$1.96 | 91205-KA3-712 | | |
| | | | | | OS244 | Clutch Pushrod Seal | \$1.29 | 91206-VA3-J02 | | |
| | | | | | OS363 | Output Shaft Seal | \$4.74 | 91201-KS6-004 | | |
| | | | Clutch & Mag Kit | List Price | Component Part# | Component Description | List Price | OEM Part # | | |
| | | | C7010CM | \$17.61 | EC228 | Clutch Cover Gasket | \$11.36 | 91311-KS6-700 | | |
| | | | | | EC510060AFM | Mag Cover Gasket | \$6.25 | 11352-KS6-700 | | |
| CR125 | 03-04 | 54 mm | C7181 | \$42.19 | H1712010S | Head Gasket 54mm Bore | \$17.38 | 12251-KZ4-A91 | | |
| | | 56 mm | C7184 | \$42.19 | H0929010S | Head Gasket 56mm Bore | \$17.38 | 12251-KZ4-A91 | | |
| | | 57 mm | C3220 | \$42.19 | H0929SP2010S | Head Gasket 57mm Bore | \$17.38 | 12251-KZ4-A91 | | |
| | | | | | B0628018AFM | Base Gasket | \$7.38 | 12191-KZ4-L30 | | |
| | | | | | B0628012F | High Compression Base Gasket | \$7.38 | | | |
| | | | | | EX006042AM | Exhaust Gasket | \$4.65 | 18291-KZ4-700 | | |
| | | | | | IR394032AFM | Intake Gasket | \$3.80 | 14132-KZ4-L30 | | |
| | | | | | PV091032AFM | Rt. Power Valve Cover Gasket 03 | \$5.34 | 12108-KZ4-A90 | | |
| | | | | | PV110018AFM | Left Power Valve Cover Gasket | \$6.19 | 12111-KZ3-L20 | | |
| | | | | | PV127032AFM | Rt. Power Valve Cover Gasket 04 | \$6.76 | 12108-KSR-A00 | | |
| | | | | | R124S | Exp. Chamber O-rings 2 Req. | \$3.74 | | | |
| | | | | | R19X3V | Water Outlet O-ring | \$3.02 | 91312-KE7-003 | | |
| | | | | | Bottom End Kit w/Oil Seals | List Price | Component Part# | Component Description | List Price | OEM Part # |
| | | | | | C7181BE | \$66.70 | EC709020F | Center Case Gasket | \$16.13 | 11191-KZ4-L30 |
| | | | | | | | WA117 | Oil Drain Plug Gasket | \$0.95 | 94109-12000 |
| | | | | | EC083032AFM | Inner Clutch Cover Gasket | \$6.71 | 11394-KZ4-A90 | | |
| | | | | | R18X3V | Fill Plug O-ring | \$1.71 | 91307-035-000 | | |
| | | | | | WP033018AFM | Water Pump Cover Gasket | \$4.94 | 19229-KZ4-620 | | |
| | | | | | WA128 | Case Cover Drain | \$1.59 | 90463-ML7-000 | | |
| | | | | | | Plug Crush Washer | | | | |
| | | | Oil Seal Kit | List Price | Component Part# | Component Description | List Price | OEM Part # | | |
| | | | C7181OS | \$34.57 | OS105 | Right Crank Seal | \$9.47 | 91203-KS6-004 | | |
| | | | | | OS227 | Water Pump Shaft Seal | \$2.67 | 91201-965-000 | | |
| | | | | | OS236 | Shift Shaft Seal | \$4.23 | 91203-KK3-830 | | |
| | | | | | OS241 | Output Shaft Seal | \$2.67 | 91201-KSR-A01 | | |
| | | | | | OS242 | Impeller Seal | \$2.67 | 91211-KA3-761 | | |
| | | | | | OS243 | Start Shaft Seal | \$1.96 | 91205-KA3-712 | | |
| | | | | | OS244 | Clutch Pushrod Seal | \$1.43 | 91206-VA3-J02 | | |
| | | | Clutch & Mag Kit | List Price | Component Part# | Component Description | List Price | OEM Part # | | |
| | | | C7181CM | \$17.61 | EC228 | Outer Clutch Cover O-ring | \$11.36 | 91311-KS6-700 | | |
| | | | | | EC510060AFM | Mag Cover Gasket | \$6.25 | 11352-KZ4-L10 | | |



MX/Dirt · Off-Road · ATV Gaskets



Cometic Gasket - An Exclusive NASCAR Performance® Product

HONDA

| Model | Year | Bore Size | Top End Kit | List Price | Component Part# | Component Description | List Price | OEM Part # |
|--------|-------|-----------|-----------------------------------|-------------------|------------------------|------------------------------------|-------------------|-------------------|
| CR125 | 05-07 | 54 mm | C3085 | \$42.19 | H2370010S | Head Gasket 54mm Bore | \$10.68 | 12251-KSR-731 |
| | | 56 mm | C3088 | \$42.19 | H2370SP1010S | Head Gasket 56mm Bore | \$10.68 | 12251-KSR-731 |
| | | 57 mm | C3221 | \$42.19 | H2370SP5010S | Head Gasket 57mm Bore | \$10.68 | 12251-KSR-731 |
| | | 58 mm | C3537 | \$42.19 | H2370SP4010S | Head Gasket 58mm Bore | \$10.68 | 12251-KSR-731 |
| | | | | | B0812014RC | Base Gasket | \$8.98 | 12191-KSR-731 |
| | | | | | B0812010RC | Base Gasket High Compression | \$10.17 | 12191-KSR-731 |
| | | | | | EX644010S | Exhaust Gasket | \$4.72 | 18291-KSR-730 |
| | | | | | PV091032AFM | Right Power Valve Cover Gasket | \$5.34 | 12108-KZ4-A90 |
| | | | | | PV132018AFM | Left Power Valve Cover Gasket | \$4.72 | 12111-KSR-730 |
| | | | | | | | | |
| | | | Bottom End Kit w/Oil Seals | List Price | Component Part# | Component Description | List Price | OEM Part # |
| | | | C3085BE | \$66.70 | EC1013020F | Center Case Gasket | \$20.22 | 11191-KSR-730 |
| | | | | | EC1014032AFM | Inner Clutch cover O-ring | \$20.22 | 11394-KSR-730 |
| | | | | | IR539032AFM | Intake Gasket | \$5.91 | 14132-KSR-731 |
| | | | | | MR039 | Center Case Coolant Passage O-Ring | \$4.20 | 91301-KSR-731 |
| | | | | | R18X3V | Fill Plug O-ring | \$1.71 | 91307-035-000 |
| | | | | | R20X2V | Power Valve Shaft O-ring | \$3.02 | 91353-KM1-004 |
| | | | | | WA128 | Case Cover Drain Plug | \$1.59 | 90463-ML7-000 |
| | | | | | | Crush Washer | | |
| | | | | | WA137 | Oil Drain Plug Gasket | \$1.53 | 94109-12000 |
| | | | | | WP395018AFM | Water Pump Cover Gasket | \$5.91 | 19229-KSR-730 |
| | | | Oil Seal Kit | List Price | Component Part# | Component Description | List Price | OEM Part # |
| | | | C7181OS | \$34.57 | OS105 | Right Crank Seal | \$9.47 | 91203-KS6-004 |
| | | | | | OS227 | Water Pump Shaft Seal | \$2.67 | 91201-965-000 |
| | | | | | OS236 | Shift Shaft Seal | \$4.23 | 91203-KK3-830 |
| | | | | | OS241 | Output Shaft Seal | \$2.67 | 91201-KSR-A01 |
| | | | | | OS242 | Impeller Seal | \$2.67 | 91211-KA3-761 |
| | | | | | OS243 | Start Shaft Seal | \$1.96 | 91205-KA3-712 |
| | | | | | OS244 | Clutch Pushrod Seal | \$1.43 | 91206-VA3-J02 |
| | | | Clutch & Mag Kit | List Price | Component Part# | Component Description | List Price | OEM Part # |
| | | | C7181CM | \$17.61 | EC228 | Outer Clutch Cover O-ring | \$11.36 | 91311-KS6-700 |
| | | | | | EC510060AFM | Mag Cover Gasket | \$6.25 | 11352-KZ4-L10 |
| TRX125 | 85-86 | 55 mm | Top End Kit | List Price | Component Part# | Component Description | List Price | OEM Part # |
| | | | C7224 | \$29.42 | H0332020C | Head Gasket | \$15.85 | 12250-VM6-003 |
| | | | | | B0195043F | Base Gasket | \$10.68 | 12191-VM6-306 |
| TRX125 | 87-88 | 57 mm | Top End Kit | List Price | Component Part# | Component Description | List Price | OEM Part # |
| | | | C7223 | \$25.55 | H0331043F | Head Gasket | \$18.56 | 12251-HB6-000/405 |
| | | | | | B0021020F | Base Gasket | \$5.34 | 12191-KT0-710 |

CRF150F,R



| Model | Year | Bore Size | EST Top End Kit | List Price | Component Part# | Component Description | List Price | OEM Part # |
|---------|-------|-----------|-----------------|------------|------------------------|-----------------------------------|-------------------|-------------------|
| CRF150F | 03-05 | 64.5 mm | C3131-EST | \$71.49 | H2490010S | Head Gasket 64.5mm | \$13.74 | 12251-KBB-901 |
| | | 67 mm | C3161-EST | \$71.49 | H2490SP1010S | Head Gasket 67mm | \$13.74 | |
| | | | | | 3231V | Valve Stem Seals 2 req. | \$6.48 ea. | 12208-413-003 |
| | | | | | B0845020F | Base Gasket | \$7.10 | 12191-KCN-000 |
| | | | | | EC1079018AFM | Cam Chain Tensioner | \$2.16 | 16214-KPS-900 |
| | | | | | EC681018AFM | Left Cylinder Head Cover | \$5.34 | 12339-KTO-710 |
| | | | | | R10X2V | Valve Guide O-rings 2 Req. | \$1.59 | 91301-KW1-900 |
| | | | | | R126V | Intake Gasket | \$1.19 | 91304-HB3-003 |
| | | | | | R151V | Cam Cover O-ring | \$2.29 | 12339-KTO-710 |
| | | | | | R35X3V | Valve Adjuster Cap O-rings 2 Req. | \$3.64 | 91303-KK3-830 |
| | | | | | Component Part# | Component Description | List Price | OEM Part # |
| | | | | | EC1076018AFM | Clutch Cover Gasket | \$11.93 | 11393-KGA-900 |

All Component Parts can be purchased individually.



MX/Dirt • Off-Road • ATV Gaskets



Cometic Gasket - An Exclusive NASCAR Performance® Product

HONDA

| Model | Year | Bore Size | EST Top End Kit | List Price | Component Part# | Component Description | List Price | OEM Part # | | |
|----------------------|----------------|-----------------------------|--------------------------|--|-----------------------------------|------------------------------|------------------------|------------------------------|-------------------|-------------------|
| CRF150F | 06-14 | 58mm 62mm | C3499-EST C3500-EST | \$33.89 \$33.89 | H2504010S | Head Gasket 58mm | \$13.74 | 12251-KRM-B41 | | |
| | | | | | H2504SP6010S | Head Gasket 62mm | \$13.74 | | | |
| | | | | | 3234V | Valve Stem Seals 2 req. | \$5.50 ea. | 12209-GB4-681 | | |
| | | | | | B0859020F | Base Gasket | \$7.10 | 12191-KWK-900 | | |
| | | | | | EC1124018AFM | Cam Chain Tensioner | \$2.16 | 14560-KRM-840 | | |
| | | | | | EX691064AM | Exhaust Gasket | \$4.20 | 18291-MN5-650 | | |
| | | | | | R126V | Intake Gasket | \$1.19 | 91304-KRM-840 | | |
| CRF150R, 07-16 RB | 66 mm 68 mm | C3187-EST C3171-EST | \$51.95 \$51.95 | H2612SP1018S H2612018S 3239V B0880014RC EC960018AFM EX784080C | Head Gasket 66mm Bore | \$27.44 | 12251-KSE-671 | | | |
| | | | | | Head Gasket 68mm Bore | \$27.44 | 12251-KSE-671 | | | |
| | | | | | Valve Stem Seal 4 Req. | \$5.50 ea. | 12208-ML0-721 | | | |
| | | | | | Base Gasket | \$11.87 | 12191-KSE-671 | | | |
| | | | | | Cam Chain Tensioner Gasket | \$3.35 | 14560-MEN-671 | | | |
| | | | | | Exhaust Gasket | \$3.35 | 18291-KZ1-670 | | | |
| | | | | | Bottom End Kit w/Oil Seals | List Price | Component Part# | Component Description | List Price | OEM Part # |
| | | | | | C3187BE | \$84.38 | EC1157020RC | Center Case Gasket | \$10.42 | 11191-KSE-670 |
| | | | | | | | WP205 | Water Pump Gasket | \$3.32 | 19226-KSE-670 |
| | | | | | | | R18X3V | Fill Plug O-ring | \$1.63 | 91307-035-000 |
| | | R27X2V | Crank Plug O-ring | \$1.92 | 91305-KF0-003 | | | | | |
| | | R113B | Water Pump Inlet Gasket | \$2.37 | 91303-377-000 | | | | | |
| | | WA118 | Water Pump Drain Washer | \$1.74 | 90463-ML7-000 | | | | | |
| | | R113B | Dip Stick O-ring | \$1.05 | 91311-PH7-003 | | | | | |
| | | R40X2V | Oil filter O-ring | \$2.09 | 91302-PA9-003 | | | | | |
| | | R18X3V | Timing Plug O-ring | \$1.45 | 91307-035-003 | | | | | |
| | | R8.5X1.5V | Oil Filter Galley O-ring | \$1.50 | 90751-GK1-003 | | | | | |
| | | Oil Seal Kit | List Price | Component Part# | Component Description | List Price | OEM Part # | | | |
| | | C3187OS | \$39.88 | OS227 | Water Pump Seal 12X22X5 | \$2.67 | 91201-148-003 | | | |
| | | | | OS236 | Shift Shaft Seal 14X22X5 | \$4.23 | 91203-KA4-771 | | | |
| | | | | OS239 | Start Shaft Seal 20X28X5 | \$2.60 | 91204-KF0-003 | | | |
| | | | | OS262 | Crank End Oil Seal 10X21X5 | \$2.60 | 91204-KRN-671 | | | |
| | | | | OS264 | Left Crank Seal 38X52X7 | \$10.97 | 91201-MEB-671 | | | |
| | | | | OS285 | Output Shaft Seal 20X30X7 | \$1.48 | 91202-KCY-761 | | | |
| | | | | OS303 | Right Crank Seal 32X48X7.5 | \$10.71 | 91201-KSE-671 | | | |
| | | | | OS304 | Oil Pump Seal 18X30X5 | \$4.62 | 91203-KSE-671 | | | |
| | | Clutch & Mag Kit | List Price | Component Part# | Component Description | List Price | OEM Part # | | | |
| | | C3187CM | \$32.09 | EC1156032AFM | Clutch Cover Gasket | \$20.22 | 11394-KSE-670 | | | |
| | | | | EC1155032AFM | Mag Cover Gasket | \$11.87 | 11395-KSE-670 | | | |
| | | Top End Kit | List Price | Component Part# | Component Description | List Price | OEM Part # | | | |
| ATC185 | 80-83 | 67 mm | C7025 | \$25.55 | H0016043F | 67mm Bore Head Gasket | \$19.82 | 12251-4B6-405 | | |
| ATC200 | 81-83 | | | | B0021020F | Base Gasket ATC 185-200 | \$5.34 | 12191-KT0-710 | | |
| ATC200E | 82-83 | | | | B0164020F | Base Gasket ATC 200ES Models | \$5.63 | | | |
| ATC200ES | 84 | | | | | | | | | |
| ATC200M | 84-85 | | | | | | | | | |
| ATC200S | 85-86 | | | | | | | | | |
| ATC200X | 83-85 | | | | | | | | | |
| TRX200 | 84 | | | | | | | | | |
| | | Top End Kit | List Price | Component Part# | Component Description | List Price | OEM Part # | | | |
| ATC200X | 86-87 | 67 mm | C7222 | \$25.55 | H0335SP1043F | Head Gasket 67mm Bore | \$18.56 | 12251-HB3-003 | | |
| TRX200 | 90-95 | | | | B0168020F | Base Gasket | \$6.25 | 12191-HFI-910 | | |
| TRX200SX | 86-88 | | | | | | | | | |



MX/Dirt · Off-Road · ATV Gaskets



Cometic Gasket - An Exclusive NASCAR Performance® Product

XR/XL200

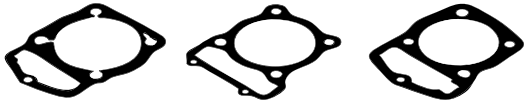

Base Base Head

| Model | Year | Bore Size | Top End Kit | List Price | Component Part# | Component Description | List Price | OEM Part # |
|--------|-------|-----------|-------------|------------|-----------------|-----------------------|------------|---------------|
| XL200R | 83-84 | 67 mm | C7234 | \$26.80 | H0334043F | Head Gasket 67mm | \$18.56 | 12251-KT0-P00 |
| XR200R | 80-83 | | | | B0021020F | Base Gasket | \$5.34 | 12191-KT0-710 |
| XR200 | 84-85 | 69 mm | C7235 | \$26.80 | H0333043F | Head Gasket 69mm | \$18.56 | 12251-KT0-P00 |
| | | | | | B0392020F | Base Gasket | \$5.34 | 12191-KZ1-920 |
| XR200R | 86-91 | 67 mm | C7236 | \$26.80 | H0334043F | Head Gasket 67mm | \$18.56 | 12251-KT0-P00 |
| | | | | | B0021020F | Base Gasket | \$5.34 | 12191-KT0-710 |
| XR200R | 92-03 | 67 mm | C7237 | \$26.80 | H0334043F | Head Gasket 67mm | \$18.56 | 12251-KT0-P00 |
| | | | | | B0021020F | Base Gasket | \$5.34 | 12191-KT0-710 |

CRF230



Base Engine Cover Clutch Cover Cam Chain Tensioner Exhaust Head

| Model | Year | Bore Size | Top End Kit | List Price | Component Part# | Component Description | List Price | OEM Part # |
|---------|-------|-----------|-------------|------------|-----------------|----------------------------------|------------|---------------|
| CRF230F | 03-16 | 66 mm | C3132-EST | \$71.49 | H2469040S | Head Gasket 66mm | \$16.69 | 12251-KT0-711 |
| | | | | | 3231V | Valve Stem Seals 2 req. | \$6.48 ea. | 12208-413-003 |
| | | | | | B0021020F | Base Gasket | \$5.34 | 12191-KT0-710 |
| | | | | | EC1079018AFM | Cam Chain Tensioner | \$2.16 | 16214-KPS-900 |
| | | | | | EC681018AFM | Left Cylinder Head Cover | \$5.34 | 12339-KTO-710 |
| | | | | | EX691064AM | Exhaust Gasket | \$4.20 | 18291-MN5-650 |
| | | | | | R10X2V . | Valve Guide O-rings 2 Req | \$1.59 | 91301-KW1-900 |
| | | | | | R126V | Intake Gasket | \$1.19 | 91304-HB3-003 |
| | | | | | R151V | Cam Cover O-ring | \$2.29 | 12339-KTO-710 |
| | | | | | R35X3V | Valve Adjuster Cap O-rings 2 Req | \$3.64 | 91303-KK3-830 |
| | | | | | Component Part# | Component Description | List Price | OEM Part # |
| | | | | | EC1076018AFM | Clutch Cover | \$11.93 | 11393-KGA-900 |

CR250

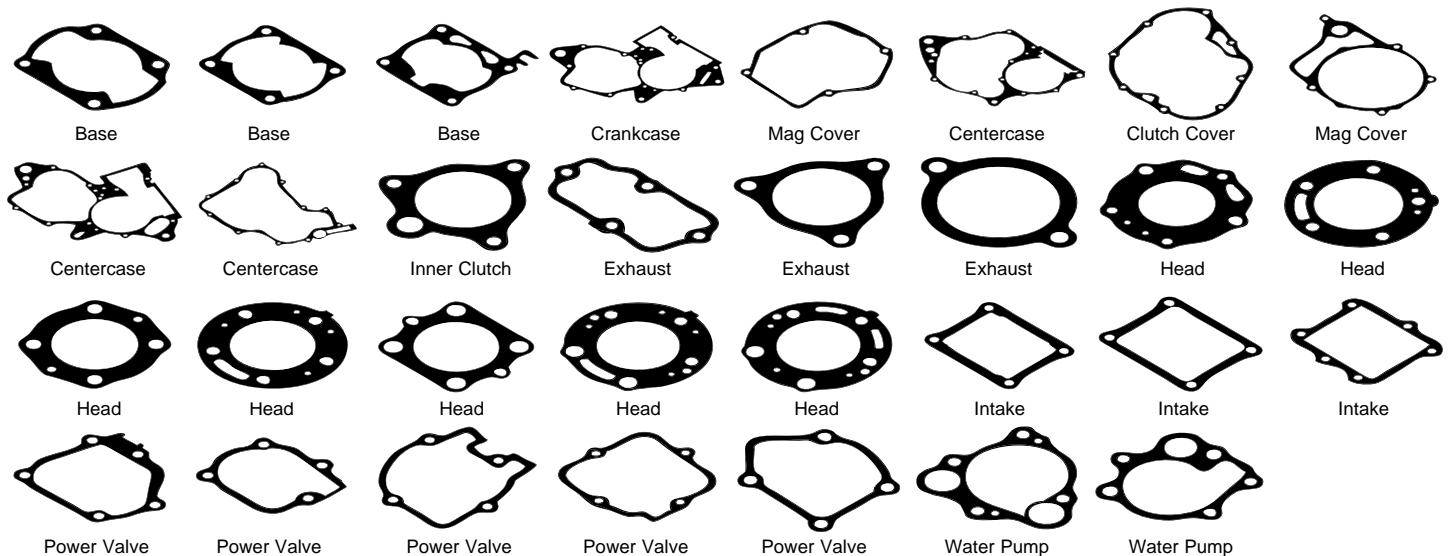

Base Base Base Crankcase Mag Cover Centercase Clutch Cover Mag Cover
Centercase Centercase Inner Clutch Exhaust Exhaust Exhaust Head Head
Head Head Head Head Head Intake Intake Intake
Power Valve Power Valve Power Valve Power Valve Power Valve Water Pump Water Pump

All Component Parts can be purchased individually.



MX/Dirt · Off-Road · ATV Gaskets



Cometic Gasket - An Exclusive NASCAR Performance® Product

HONDA

| Model | Year | Bore Size | Top End Kit | List Price | Component Part# | Component Description | List Price | OEM Part # |
|---------------|-------|-----------|---------------------------------------|-------------------|------------------------|---|-------------------|-------------------------------------|
| ATC250R | 81-84 | 72 mm | C7021 | \$35.72 | H0014043F | Head Gasket | \$19.82 | 12254-961-010 |
| | | | | | B0018020F | Base Gasket | \$6.25 | 12191-961-306 |
| | | | | | IR004018AFM | Intake Gasket | \$3.80 | 14132-430-000 |
| ATC250R | 85-86 | 68 mm | C7349 | \$40.88 | H0009010S | Head Gasket 68mm | \$28.51 | 12254-KS7-881 |
| | | 69.5 mm | C7350 | \$40.88 | H0195010S | Head Gasket 69.5mm | \$28.51 | |
| | | 72 mm | C7351 | \$40.88 | H0196010S | Head Gasket 72mm | \$28.51 | |
| | | | | | B0019020F | Base Gasket | \$6.25 | 12191-HA2-306 |
| | | | | | IR004018AFM | Intake Gasket Cylinder to Reed | \$3.80 | 14132-430-000 |
| | | | | | IR005018AFM | Intake Gasket Reed Block to Intake Manifold | \$3.80 | 14133-430-000 |
| | | | Bottom End Kit w/o crank seals | List Price | Component Part# | Component Description | List Price | OEM Part # |
| | | | C3320 | \$44.67 | C7520 | Clutch Cover Gasket | \$13.99 | 11395-HA2-003 |
| | | | | | EC312047F | Mag Cover Gasket | \$8.29 | 11352-HA2-000 |
| | | | | | EC313020F | Center Case Gasket | \$10.90 | 11191-HA2-000 |
| | | | | | WP071020F | Water Pump Gasket | \$2.38 | 19229-HAZ-000 |
| | | | Crank Seal Kit | List Price | Component Part# | Component Description | List Price | OEM Part # |
| | | | C7671 | \$18.15 | OS106 | 38X58X11 Right Crank Seal | \$10.68 | 91201-KA4-004 |
| | | | | | OS108 | 27X50X8 Left Crank Seal | \$9.47 | 91202-HA2-771 |
| MR250, MT250, | 73-77 | 72 mm | C7140 | \$25.55 | H0182043F | Head Gasket 72mm | \$19.28 | 12251-358-306 |
| | | | | | B0137020F | Base Gasket 73-76 | \$6.25 | 12191-357-306 |
| | | | | | B0395020F | Base Gasket 77-84 | \$5.34 | 12191-381-306 |
| CR250 | 73-74 | 71 mm | C7811 | \$25.55 | H0912020C | Head Gasket 71mm | \$14.20 | 12251-357-020 |
| | | | | | B0137020F | Base Gasket | \$6.25 | 12191-357-306 |
| | | | | | EX250020C | Exhaust Gasket | \$9.99 | 18359-357-000 |
| | | | | | IR133031F | Intake Gasket | \$3.80 | 16229-357-010 |
| | | | Bottom End Kit w/o crank seals | List Price | Component Part# | Component Description | List Price | OEM Part # |
| | | | C3321 | \$30.11 | EC357031F | Center Case Gasket | \$11.81 | 11191-357-030 |
| | | | | | EC358031F | Clutch Cover Gasket | \$18.56 | 11394-357-040/306 |
| | | | | | EC394020F | Mag Cover Gasket | \$6.25 | 11395-357-020 |
| CR250 | 78-80 | 71 mm | C7278 | \$34.47 | H0359020C | Head Gasket 71mm | \$14.20 | 12254-430-000 |
| | | | | | B0210020F | Base Gasket | \$6.25 | 12191-430-306 |
| | | | | | EX293SP1042AM | Exhaust Gasket | \$9.94 | 18291-430-000 |
| | | | | | IR004018AFM | Intake Gasket | \$3.80 | 14132-KAE-000 |
| | | | | | IR005018AFM | Intake Gasket | \$3.80 | 14133-430-000 |
| | | | Bottom End Kit w/o crank seals | List Price | Component Part# | Component Description | List Price | OEM Part # |
| | | | C3322 | \$31.15 | EC465031F | Inner Clutch Cover | \$14.93 | |
| | | | | | EC486020F | Center Case Gasket | \$13.17 | 11191-430-010 |
| | | | | | EC487020F | Mag Cover Gasket | \$9.94 | 11395-430-306 |
| CR250 | 81-82 | 68 mm | C7011 | \$25.55 | H0007043F | Head Gasket | \$17.38 | 12254-KA4-004/306 |
| | | | | | B0010020F | Base Gasket | \$6.25 | 12191-KA4-306 |
| | | | | | IR004018AFM | Intake Gasket | \$3.80 | 14132-KAE-000 |
| | | | | | IR005018AFM | Intake Gasket | \$3.80 | 14133-430-000 |
| | | | Bottom End Kit w/o crank seals | List Price | Component Part# | Component Description | List Price | OEM Part # |
| | | | C3323 | \$50.99 | EC801032AFM | Clutch Cover Gasket | \$14.93 | 31129-KA4-000/ 11395-KA4-000/306 |
| | | | | | EC802020F | Center Case Gasket | \$13.17 | 11191-KA4-000 |
| | | | | | EC803060AFM | Mag Cover Gasket | \$9.94 | 11395-KA4-710 |
| | | | | | EX397042AM | Exhaust Gasket | \$4.65 | 18291-430-000/306 |
| | | | | | WP157032AFM | Water Pump Gasket | \$4.72 | 19229-KA4-307 |
| CR250 | 83 | 68 mm | C7108 | \$25.55 | H0008043F | Head Gasket | \$19.82 | 12254-KA4-710 |
| | | | | | B0010020F | Base Gasket | \$6.25 | 12191-KA4-306 |
| | | | | | EC801032AFM | Clutch Cover Gasket | \$14.93 | 31129-KA4-000/ 11395-KA4-000/306 |
| | | | Crank Seal Kit | List Price | Component Part# | Component Description | List Price | OEM Part # |
| | | | C7697 | \$18.15 | OS103 | Left Side Crank Seal 20X32X7 | \$9.47 | 91205-166-004 |
| | | | | | OS106 | Right Crank Seal 38X58X11 | \$10.68 | 91201-KA4-004 |



MX/Dirt · Off-Road · ATV Gaskets



Cometic Gasket - An Exclusive NASCAR Performance® Product

HONDA

| Model | Year | Bore Size | Top End Kit | List Price | Component Part# | Component Description | List Price | OEM Part # |
|------------------------|------------------------------|-------------------|-------------------|------------|------------------------|--------------------------------|-------------------|-------------------|
| CR250 | 84 | 68 mm | C7012 | \$25.55 | H0008043F | Head Gasket | \$19.82 | 12254-KA4-710 |
| | | | | | B0011020F | Base Gasket | \$6.25 | 12191-KA4-307 |
| CR250 | 85 | 68 mm | C7013 | \$35.72 | Component Part# | Component Description | List Price | OEM Part # |
| | | | | | C7490 | Clutch Cover Gasket | \$11.47 | 91311-KS7-701 |
| | | | | | H0009043F | Head Gasket | \$19.82 | 12254-KS7-881 |
| | | | | | B0012020F | Base Gasket | \$6.25 | 12191-KS7-306 |
| | | | | | EX007042AM | Exhaust Gasket | \$4.65 | 18291-KA4-770 |
| | | | | | IR004018AFM | Intake Gasket | \$3.80 | 14132-430-000 |
| | | | | | IR005018AFM | Intake Gasket | \$3.80 | 14133-430-000 |
| | | | | | Component Part# | Component Description | List Price | OEM Part # |
| | | | | | C7490 | Clutch Cover Gasket | \$11.47 | 91311-KS7-701 |
| | | | | | Component Part# | Component Description | List Price | OEM Part # |
| C7697 | Crank Seal Kit | \$18.15 | | | | | | |
| CR250 | 86-91 | 68 mm | C7015 | \$38.33 | Component Part# | Component Description | List Price | OEM Part # |
| | | | | | H0009043F | Head Gasket | \$19.82 | 12254-KS7-881 |
| | | | | | B0013020F | Base Gasket | \$6.25 | 12191-KS7-306 |
| | | | | | B0013012F | High Comp. Base Gasket .012" | \$9.32 | |
| | | | | | EX008042AM | Exhaust Gasket | \$4.65 | 18291-KS7-000 |
| | | | | | IR004018AFM | Intake Gasket Cylinder to Reed | \$3.80 | 14132-430-000 |
| | | | | | IR020020F | Intake Gasket Reed to Carb | \$3.80 | 14133-KS7-000 |
| | | | | | PV004018AFM | Side Power Valve Gasket | \$3.80 | 12108-KS7-000 |
| | | | | | PV005020F | Upper Left Power Valve Gasket | \$3.80 | 12113-KS7-000 |
| | | | | | PV006020F | Upper Right Power Valve Gasket | \$3.80 | 12114-KS7-000 |
| CR250 | 92-01 | 68.5 mm | C7116 | \$38.33 | Component Part# | Component Description | List Price | OEM Part # |
| | | | | | C7490 | Clutch Cover Gasket | \$11.47 | 91311-KS7-701 |
| | | | | | H0247010S | Head Gasket | \$28.51 | 12254-KZ3-860 |
| | | | | | B0014018AFM | Base Gasket | \$6.25 | 12191-KZ3-880 |
| | | | | | IR004018AFM | Intake Gasket | \$3.80 | 14132-430-000 |
| | | | | | PV007018AFM | Right Side Power Valve Gasket | \$3.80 | 12108-KZ3-880 |
| | | | | | R221V | Exhaust O-rings 2 Req. | \$3.92 | 91304-KZ3-890 |
| | | | | | Component Part# | Component Description | List Price | OEM Part # |
| | | | | | C7116BE | Bottom End Kit w/Oil Seals | \$66.70 | |
| | | | | | CR250 | 92-01 | 68.5 mm | C7116OS |
| MR129 | Case Water Galley O-ring | \$4.20 | 91301-KZ3-861 | | | | | |
| EC187020F | Crank Case Gasket | \$18.56 | 11191-KZ3-J20 | | | | | |
| WA137 | Drain Plug Gasket | \$1.53 | 94109-12000 | | | | | |
| R18X3V | Fill Plug O-ring | \$1.71 | 91307-035-000 | | | | | |
| WA128 | Clutch Drain Washer | \$1.59 | 90463-ML7-000 | | | | | |
| WP034018AFM | Water Pump Gasket | \$5.00 | 19229-KZ3-880 | | | | | |
| EC084032AFM | Inner Clutch Cover Gasket | \$9.32 | 11395-KZ3-880 | | | | | |
| Component Part# | Component Description | List Price | OEM Part # | | | | | |
| OS107 | Left Crank Seal | \$8.29 | 91205-KZ3-861 | | | | | |
| OS106 | Right Crank Seal | \$10.68 | 91201-KA4-004 | | | | | |
| OS227 | Water Pump Shaft Seal | \$2.67 | 91201-965-000 | | | | | |
| OS236 | Shift Shaft Seal | \$4.23 | 91203-KA4-772 | | | | | |
| | | | 91203-KK3-830 | | | | | |
| | | | 91203-KA4-771 | | | | | |
| OS238 | Output Shaft Seal | \$3.17 | 91207-ML3-871 | | | | | |
| OS239 | Start Shaft Seal | \$2.60 | 91204-KF0-003 | | | | | |
| OS240 | Clutch Pushrod Seal | \$2.43 | 91201-951-003 | | | | | |
| OS242 | Impeller Shaft Seal | \$2.67 | 91211-KA3-761 | | | | | |
| Component Part# | Component Description | List Price | OEM Part # | | | | | |
| EC196 | Clutch & Mag Kit | \$14.77 | | | | | | |
| EC082063N | Outer Clutch O-ring | \$10.68 | 91311-KS7-701 | | | | | |
| | Mag Cover Gasket | \$4.09 | 11352-KA4-771 | | | | | |



MX/Dirt · Off-Road · ATV Gaskets



Cometic Gasket - An Exclusive NASCAR Performance® Product

HONDA

| Model | Year | Bore Size | Top End Kit | List Price | Component Part# | Component Description | List Price | OEM Part # | |
|-------|---------|-----------|-----------------------------|-------------------------------------|------------------------|---|------------------------------|-------------------|-------------------|
| CR250 | 02-04 | 66.5 mm | C7191 | \$44.29 | H1288SP1010S | 66.5mm Bore Head Gasket | \$28.51 | 14132-KZ3-L20 | |
| | | 68.5 mm | C7197 | \$44.29 | H1288010S | 68.5mm Bore Head Gasket | \$28.51 | 12254-KSK-731 | |
| | | | | | B0546018AFM | Base Gasket .018" | \$6.25 | 12191-KZ3-L20 | |
| | | | | | B0546012F | High Comp. Base Gasket .012" | \$9.32 | | |
| | | | | | IR232018AFM | Intake Gasket | \$3.80 | 18291-KZ3-L20 | |
| | | | | | EX456010S | Exhaust Gasket | \$5.00 | 12111-KZ3-L20 | |
| | | | | | PV110018AFM | Power Valve Gasket | \$6.19 | 12254-KSK-731 | |
| | | | | Bottom End Kit w/Oil Seals | List Price | Component Part# | Component Description | List Price | OEM Part # |
| | | | | C7191BE | \$66.70 | EC5910322AFM | Inner Clutch Cover Gasket | \$13.62 | 11395-KZ3-L20 |
| | | | | | | EC592020F | Center Case Gasket | \$14.87 | 11191-KSK-670 |
| | | | | | IR232018AFM | Intake Gasket | \$3.80 | 14132-KZ3-L20 | |
| | | | | | MR037 | Center Case O-ring | \$3.69 | 91301-KZ3-L20 | |
| | | | | | R18X3V | Fill Plug O-ring | \$1.71 | 91307-035-000 | |
| | | | | | WA128 | Case Drain Washer 2 Required | \$1.59 | 90463-ML7-000 | |
| | | | | | WA137 | Drain Plug Gasket | \$1.53 | 94109-12000 | |
| | | | | | WP131018AFM | Water Pump Gasket 2 Required | \$5.91 | 19229-KZ3-L20 | |
| | | | Oil Seal Kit | List Price | Component Part# | Component Description | List Price | OEM Part # | |
| | | | C7191OS | \$36.74 | OS107 | Left Crank Seal 20x37x7 | \$8.29 | 91205-KZ3-861 | |
| | | | | | OS227 | Water Pump Shaft Seal 12x22x5 | \$2.67 | 91201-965-000 | |
| | | | | | OS236 | Shift Shaft Seal 14x22x5 | \$4.23 | 91203-KA4-771 | |
| | | | | | OS238 | Output Shaft Seal 31x40x7 | \$3.17 | 91207-ML3-871 | |
| | | | | | OS239 | Start Shaft Seal 20x28x5 | \$2.60 | 91204-KF0-003 | |
| | | | | | OS240 | Clutch Actuator Seal 12x18x3 | \$2.43 | 91201-951-003 | |
| | | | | | OS242 | Impeller Seal 12x25x7 | \$2.67 | 91211-KA3-761 | |
| | | | Clutch & Mag Kit | List Price | Component Part# | Component Description | List Price | OEM Part # | |
| | | | C7191CM | \$15.56 | EC196 | Outer Clutch O-ring | \$10.68 | 91311-KS7-701 | |
| | | | | | EC5900032AFM | Mag Cover Gasket | \$13.62 | 11352-KZ3-L21 | |
| CR250 | 05-07 | 66.5 mm | C3089 | \$44.29 | H2368010S | Head Gasket | \$12.99 | 12254-KSK-731 | |
| | | 68.5 mm | C3092 | \$44.29 | H2388010S | Head Gasket 68.5mm Bore | \$12.99 | | |
| | | | | | B0811014RC | Base Gasket | \$10.17 | 12191-KSK-731 | |
| | | | | | PV110018AFM | Power Valve gasket | \$6.19 | 12111-KZ3-L20 | |
| | | | | | R14X2.5V | Exh. Valve Cover O-rings 4 req. | \$1.13 | 91302-KSK-731 | |
| | | | | | R43X3V | Exp. Chamber O-rings 2 req. | \$3.71 | 91304-KZ3-890 | |
| | | | | | WA139 | Head Washer 2 Req. | \$1.83 | 90442-028-000 | |
| | | | | | EX456010S | Exhaust Manifold Gasket | \$5.00 | 18291-KZ3-L20 | |
| | | | | | IR232032AFM | Intake Gasket | \$3.80 | 14132-KZ3-L20 | |
| | | | | Bottom End Kit w/crank seals | List Price | Component Part# | Component Description | List Price | OEM Part # |
| | | | | C3325 | \$48.87 | EC592020F | Centercase Gasket | \$14.87 | 11191-KSK-730 |
| | | | | | | EC590032AFM | Mag Cover Gasket | \$13.62 | 11352-KZ3-L20 |
| | | | | | | EC591032AFM | Inner Clutch Cover Gasket | \$13.62 | 11395-K23-L20 |
| | TRX250R | 86-89 | 68 mm | C7349 | \$40.88 | H0009010S | Head Gasket 68mm | \$28.51 | 12254-KS7-881 |
| | | | 69.5 mm | C7350 | \$40.88 | H0195010S | Head Gasket 69.5mm | \$28.51 | |
| 72 mm | | | C7351 | \$40.88 | H0196010S | Head Gasket 72mm | \$28.51 | | |
| | | | | | B0019020F | Base Gasket | \$6.25 | 12191-HA2-306 | |
| | | | | | IR004018AFM | Intake Gasket Cylinder to Reed | \$3.80 | 14132-430-000 | |
| | | | | | IR005018AFM | Int. Gasket Reed Block to Int. Manifold | \$3.80 | 14133-430-000 | |
| | | | | Bottom End Kit w/crank seals | List Price | Component Part# | Component Description | List Price | OEM Part # |
| | | | | C3220 | \$42.19 | C7520 | Clutch Cover Gasket | \$13.99 | 11394-HA7-690 |
| | | | | | | WP071020F | Water Pump Gasket | \$2.38 | 19229-HAZ-000 |
| | | | | | | EC312047F | Mag Cover Gasket | \$8.29 | 11352-HA2-000 |
| | | | | | | EC313020F | Center Case Gasket | \$10.90 | 11191-HAZ-000 |
| | | | | Crank Seal Kit | List Price | Component Part# | Component Description | List Price | OEM Part # |
| | | | | C7672 | \$20.45 | OS108 | Left Side Crank Seal 27X50X8 | \$9.47 | 91202-HA2-771 |
| | | | | | | OS106 | Right Crank Seal 38X58X11 | \$10.68 | 91201-KA4-004 |



MX/Dirt · Off-Road · ATV Gaskets



Cometic Gasket - An Exclusive NASCAR Performance® Product

CRF250R & CRF250X

| Model | Year | Bore Size | EST | List Price | Component Part# | Component Description | List Price | OEM Part # |
|----------|-------|-----------|--------------------|------------|------------------------|---|-------------------|-------------------|
| | | | Top End Kit | | | | | |
| CRF250R, | 04-09 | 78 mm | C3133-EST | \$69.63 | H2334027S | Head Gasket 78mm Bore | \$22.83 | 12251-KRN-671/731 |
| CRF250X | 04-13 | 79 mm | C7185-EST | \$69.63 | H2145027S | Head Gasket 79mm Bore | \$22.83 | 12251-KRN-671/731 |
| | | 81 mm | C7189-EST | \$69.63 | H2069027S | Head Gasket 81mm Bore | \$22.83 | |
| | | | | | 3234V | Int. & Exh. Valve Seals 04-07 4 Req. | \$5.50 ea. | 12209-GB4-681 |
| | | | | | B0694014RC | Base Gasket .014 | \$13.47 | 12191-KRN-731 |
| | | | | | EC960018AFM | Cam Chain Tensioner Gasket | \$3.35 | 14560-MEN-671 |
| | | | | | EX169064AM | Exhaust Gasket | \$1.93 | 18291-MM5-860 |
| | | | | | MA0164 | Cam Chain Tensioner Bolt Seal | \$0.93 | 90442-397-000 |
| | | | | | R14X2.5V | Head Oil Drain Cap O-ring | \$1.13 | 91303-377-000 |
| | | | | | R19X3V | Water Outlet O-ring | \$3.02 | 91312-KE7-003 |
| | | | | | 3239V | Exh. Valve Seals 08-09 2 Req. | \$5.50 ea. | 12208-ML0-721 |
| | | | | | WA110 | Air Recirculation Valve Seal | \$0.80 | 90452-323-000 |
| | | | | | Component Part# | Component Description | List Price | OEM Part # |
| | | | | | C3069 | Valve Cover Gasket | \$13.46 | 12391-KRN-670 |

CRF250R, 04-09

| Bottom End Kit w/Oil Seals C7185BE | List Price | Component Part# | Component Description | List Price | OEM Part # |
|--|-------------------------------|------------------------|--------------------------------|-------------------|-------------------|
| | \$115.59 | WP170 | Molded Rubber Water Pump | \$16.99 | 19226-KRN-670 |
| | | WA111 | Water Pump Imp. Seals 2 Req. | \$0.80 | 90447-KE1-000 |
| | | WA128 | Coolant Drain Bolt Washer | \$1.59 | 90463-ML7-000* |
| | | WA128 | Coolant Drain Bolt Washer | \$1.59 | 90463-ML7-000* |
| | | EC959032AFM | Inner Clutch Cover Gasket | \$14.93 | 11394-KRN-670 |
| | | R16X2.5V | Water Passage Collar O-ring | \$1.26 | 91304-MJ0-003 |
| | | R27x2V | Clutch Cover Cap O-ring | \$1.86 | 91305-KF0-003 |
| | | R12X2V | Trans Oil Fill Cap O-ring | \$4.09 | 91370-461-000* |
| | | R18X3V | Crank Dipstick O-ring | \$1.71 | 91307-035-000 |
| | | R8.5X2V | Oil Filter Relief Valve O-ring | \$1.10 | 90751-GK1-003 |
| | | R40X2V | Oil Filter Cover O-ring | \$2.82 | 91302-PA9-003 |
| | | R14X2.5V | Mag Side Cap O-ring | \$1.13 | 91303-377-000 |
| | | EC958020F | Case Gasket | \$11.93 | 111910-KRN-670 |
| Oil Seal Kit C7185OS | List Price \$41.28 | Component Part# | Component Description | List Price | OEM Part # |
| | | OS243 | Start Shaft Seal 16.5x25x5 | \$1.96 | 91205-KA3-712 |
| | | OS283 | Water Pump Shaft Seal 11x25x7 | \$2.74 | 91211-KRN-671 |
| | | OS227 | Impeller Shaft Seal 12x22x5 | \$2.67 | 91201-965-000 |
| | | OS266 | Right Crank Seal 39x52x7 | \$10.97 | 91202-MEB-671 |
| | | OS236 | Shift Shaft Seal 14x22x5 | \$4.23 | 91203-KA4-771 |
| | | OS264 | Left Crank Seal 39x52x7 | \$10.97 | 91202-MEB-671 |
| | | OS261 | Oil Pump Seal 20x33x5 | \$2.64 | 91203-MEB-671 |
| | | OS240 | Clutch Actuator Seal 12x18x3 | \$2.43 | 91201-951-003 |
| | | OS241 | Output Shaft Seal 28x37x7 | \$2.67 | 91201-KSR-A01 |
| Clutch & Mag Kit C7185CM | List Price \$12.51 | Component Part# | Component Description | List Price | OEM Part # |
| | | EC957018AFM | Mag Cover Gasket | \$9.32 | 11395-KRN-670 |
| | | R150X2B | Outer Clutch Cover Gasket | \$14.93 | 11352-KRN-671 |



MX/Dirt • Off-Road • ATV Gaskets



Cometic Gasket - An Exclusive NASCAR Performance® Product

HONDA

| Model | Year | Bore Size | EST | List Price | Component Part# | Component Description | List Price | OEM Part # |
|-----------------------------------|---------|-------------------|------------------------|----------------------------------|-------------------|-----------------------|------------|---------------|
| CRF250R | 10-16 | 78mm | Top End Kit | | | | | |
| | | | C3288-EST | \$55.38 | H3017027S | 78mm Bore Head Gasket | \$25.95 | 12251-KRN-A41 |
| | | | C3289-EST | \$55.38 | H3017SP3027S | 80mm Bore Head Gasket | \$25.95 | |
| | | 80mm | C3290-EST | \$55.38 | H3017SP2027S | 82mm Bore Head Gasket | \$25.95 | |
| | | | B1005014RC | Base Gasket | \$13.47 | 12191-KRN-A41 | | |
| | | | EX169064AM | Exhaust Gasket | \$1.93 | 18291-MM5-860 | | |
| | | 82mm | EC960018AFM | Cam Chain Tensioner Gasket | \$3.35 | 14560-MEN-671 | | |
| | | | 3239V | Exh. Valve Seals 08-10 2 Req. | \$5.50 ea. | 12208-ML0-721 | | |
| | | | 3234V | Int. Valve Seal 2010 2Req. | \$5.50 ea. | 12209-GB4-681 | | |
| | | | R19X3V | Water Outlet O-ring | \$3.02 | 91312-KE7-003 | | |
| Bottom End Kit w/Oil Seals | | List Price | Component Part# | Component Description | List Price | OEM Part # | | |
| | C3288BE | \$92.58 | EC1543032AFM | Inner Clutch Cover Gasket | \$14.93 | 11394-KRN-A40 | | |
| | | | EC1544020RC | Center Case Gasket | \$11.93 | 11191-KRN-A40 | | |
| | | | MA0165 | Drain Plug Washer | \$0.81 | 90474-333-000 | | |
| | | | R012V | Oil Relief Valve O-ring | \$1.08 | 90751-GK1-003 | | |
| | | | R14X2.5V | Timing Mark Cap O-ring | \$1.13 | 91303-377-000 | | |
| | | | R14X3V | Dipstick O-ring | \$1.13 | 91307-KRN-A41 | | |
| | | | R114V | Inner Clutch Dowel O-ring | \$1.19 | 91304-MJ0-003 | | |
| | | | R18X3V | Trans Fluid Fill Plug O-ring | \$1.71 | 91307-035-000 | | |
| | | | R27X2V | Clutch Cover Drain Plug O-ring | \$1.86 | 91305-KF0-003 | | |
| | | | R40X2V | Oil Filter O-ring | \$2.82 | 91302-PA9-003 | | |
| | | | WP369 | Water Pump Gasket | | 19226-KRN-A40 | | |
| Oil Seal Kit | | List Price | Component Part# | Component Description | List Price | OEM Part # | | |
| | C3288OS | \$37.10 | OS236 | Shift Shaft Seal 14x22x5 | \$2.42 | 91203-KA4-771 | | |
| | | | OS240 | Clutch Push Rod Oil Seal 12x18x3 | \$2.34 | 91205-MEB-671 | | |
| | | | OS241 | Output Shaft Oil Seal 28x37x7 | \$2.57 | 91201-KSR-A01 | | |
| | | | OS243 | Kick Start Shaft Seal 16.5x25x5 | \$1.88 | 91205-KA3-712 | | |
| | | | OS262 | Left Case Oil Seal 10x21x5 | \$2.50 | 91204-MEN-A31 | | |
| | | | OS264 | Left Crank Seal 38x52x7 | \$5.68 | 91201-MEB-671 | | |
| | | | OS266 | Right Crank Seal 39x56x7.5 | \$10.97 | 91202-MEY-671 | | |
| | | | OS387 | Balancer Shaft Seal 24x36x8 | \$6.17 | 91205-KE1-004 | | |
| Clutch & Mag Kit | | List Price | Component Part# | Component Description | List Price | OEM Part # | | |
| | C3288CM | \$12.51 | R150x2B | Outer Clutch Cover | \$3.19 | 11352-KRN-A41 | | |
| | | | EC1545032AFM | Mag Cover Gasket | \$9.32 | 11395-KRN-A40 | | |

XR/XL250

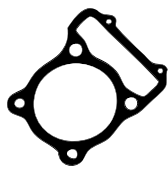

Base

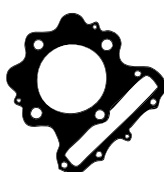

Head

| Model | Year | Bore Size | Top End Kit | List Price | Component Part# | Component Description | List Price | OEM Part # |
|--------|-------|---------------------------------------|-------------|-------------------|------------------------|------------------------------|-------------------|-------------------|
| XL250 | 86-05 | 74 mm | C7145 | \$29.35 | H0238043F | Head Gasket 74mm Bore | \$20.99 | 12251-KV6-003 |
| XR250R | 86-05 | 78 mm | C7146 | \$29.35 | H0192043F | Head Gasket 78mm Bore | \$20.99 | 12251-KV6-003 |
| | | | | | B0144020F | Base Gasket | \$9.32 | 12191-KZ1-920 |
| | | Top End Kit | | List Price | Component Part# | Component Description | List Price | OEM Part # |
| XL250 | 91-96 | 74 mm | C7821 | \$35.72 | H0238030S | 74mm Head Gasket .030" | \$24.75 | 12251-KCZ-013 |
| XR250R | 86-95 | 77 mm | C7893 | \$35.72 | H1401030S | 77mm Head Gasket .030" | \$24.75 | |
| XR250R | 96-04 | 78 mm | C7822 | \$35.72 | H0192030S | 78mm Head Gasket .030" | \$24.75 | 12251-KCZ-013 |
| | | Bottom End Kit w/o crank seals | | List Price | Component Part# | Component Description | List Price | OEM Part # |
| | | C3330 | | \$27.44 | EC424032AFM | Clutch Cover Gasket | \$12.39 | 11394-KZ1-920 |
| | | | | | EC423060AFM | Mag Cover Gasket | \$8.29 | 11395-KZ1-920 |
| | | | | | EC571020F | Center Case Gasket | \$13.62 | 11191-KZ1-920 |
| | | | | | Component Part# | Component Description | List Price | OEM Part # |
| | | | | | VC033010S | Valve Cover Gasket | \$27.88 | 12391-KR6-010 |



MX/Dirt · Off-Road · ATV Gaskets



Cometic Gasket - An Exclusive NASCAR Performance® Product

TRX250EX

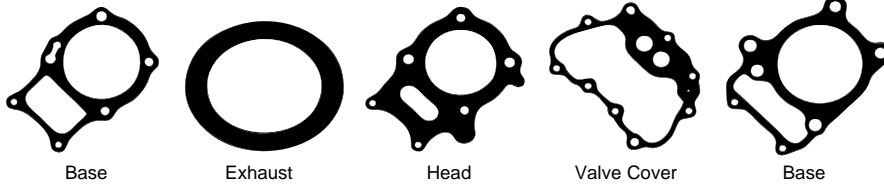

| Model | Year | Bore Size | Top End Kit | List Price | Component Part# | Component Description | List Price | OEM Part # |
|-----------|-------|-----------|---------------------------------------|-------------------|------------------------|------------------------------|-------------------|-----------------------|
| ATC250ES | 85-87 | 75 mm | C7026 | \$25.55 | H0017043F | Head Gasket | \$19.82 | 12251-HA0-004 |
| ATC250SX | | | | | B0022020F | Base Gasket | \$6.25 | 12191-HA7-921 |
| TRX250 | | | | | | | | |
| TRX300 | 85-01 | | | | | | | |
| | | | EST Top End Kit | List Price | Component Part# | Component Description | List Price | OEM Part # |
| TRX250EX | 01-16 | 70mm | C3153-EST | \$77.46 | H2473010S | Head Gasket | \$17.32 | 12251-HN6-000 |
| TRX250TE | | | | | 3231V | 3231V Valve Seals 4 Req. | 6.48 ea. | 12209-KL4-005 |
| TRX250TM | | | | | B0846020RC | Base Gasket | \$11.87 | 12191-HM8-000 |
| | | | | | EX691064AM | Exhaust Gasket | \$4.20 | 18291-MN5-650 |
| | | | | | R10X2V | Valve Guide O-ring 2 req. | \$1.59 | 91301-200-000 |
| | | | | | R219V | Tappet Cover O-rings 2 Req. | \$3.92 | 12392-HC4-005 |
| | | | | | R8X2V | Rocker Shaft O-rings 2 Req. | \$1.13 | 91303-428-003 |
| | | | | | | | | |
| | | | | | Component Part# | Component Description | List Price | OEM Part # |
| | | | | | VC135018AFM | Valve Cover Gasket | \$11.87 | 12315-HN6-010 |
| | | | | | EC1092032AFM | Clutch Cover Gasket | \$23.85 | 11394-HM8-000 |
| | | | EST Top End Kit | List Price | Component Part# | Component Description | List Price | OEM Part # |
| TRX250X | 87-92 | 75 mm | C7143-EST | \$80.99 | H2475027S | 75mm Bore Head Gasket | \$27.26 | 12251-HC0-013 |
| | | 78 mm | C7906-EST | \$80.99 | H2475SP2027S | 78mm Bore Head Gasket | \$27.26 | 12251-HC0-013 |
| | | | | | 3231V | Valve Seals 4 Req. | 6.48 ea. | 12209-KL4-005 |
| | | | | | B0165020F | Base Gasket | \$6.25 | 12191-HM3-670 |
| | | | | | EC036018AFM | Cam Chain Tensioner Gasket | \$2.04 | 12194-HC5-740 |
| | | | | | R10X2V | Valve Guide O-ring 4 req. | \$1.59 | 91301-200-000 |
| | | | | | R35X3V | Intake Manifold O-ring | \$3.64 | 91305-HA5-000 |
| | | | | | R57X2V | Tappet Cover O-ring | \$3.20 | 12392-HC4-005 |
| | | | | | R78X2V | Base O-ring | \$4.29 | 91302-428-000 |
| | | | | | R7X2.5B | Rocker Shaft O-rings 2 Req | \$3.43 | 91303-428-003 |
| | | | | | | | | |
| | | | | | Component Part# | Component Description | List Price | OEM Part # |
| | | | | | C7712 | Clutch Cover Gasket | \$12.78 | 11395-HA2-003 |
| | | | EST Top End Kit | List Price | Component Part# | Component Description | List Price | OEM Part # |
| Fourtrax | 92-09 | 75 mm | C7143-EST | \$80.99 | H2475027S | 75mm Bore Head Gasket | \$27.26 | 12251-HC0-013 |
| TRX300EX | | 78 mm | C7906-EST | \$80.99 | H2475SP2027S | 78mm Bore Head Gasket | \$27.26 | 12251-HC0-013 |
| | | 80 mm | C7525-EST | \$80.99 | H2475SP3027S | 80mm Bore Head Gasket | \$27.26 | 12251-HC0-013 |
| | | 81 mm | C7527-EST | \$80.99 | H2475SP5027S | 81mm Bore Head Gasket | \$27.26 | 12251-HC0-013 |
| | | | | | B0165020F | Base Gasket | \$6.25 | 12191-HM3-670 |
| | | | | | 3231V | Valve Seals 4 Req. | \$6.48 ea. | 12209-KL4-005 |
| | | | | | EC036018AFM | Cam Chain Tensioner Gasket | \$2.04 | 12194-HC5-740 |
| | | | | | R10X2V | Valve Guide O-ring 4 req. | \$1.59 | 91301-200-000 |
| | | | | | R35X3V | Intake Manifold O-ring | \$3.64 | 91305-HA5-000 |
| | | | | | R57X2V | Tappet Cover O-ring | \$3.20 | 12392-HC4-005 |
| | | | | | R78X2V | Base O-ring | \$4.29 | 91302-428-000 |
| | | | | | R7X2.5B | Rocker Shaft O-rings | \$3.43 | 91303-428-003 |
| | | | | | | | | |
| | | | Bottom End Kit w/o crank seals | List Price | Component Part# | Component Description | List Price | OEM Part # |
| | | | C3332 | \$47.58 | C7712 | Clutch Cover Gasket | \$12.78 | 11395-HA2-003 |
| | | | | | EC309020F | Starter Cover Gasket | \$12.39 | 11356-HM3-670 |
| | | | | | EC310020F | Centercase Gasket | \$22.32 | 11191-HM3-670 |
| | | | | | EC308020F | Mag Cover Gasket | \$12.39 | 11395-HM3-670 |
| | | | Top End Kit | List Price | Component Part# | Description | List Price | OEM Part# |
| ATC350X | 85-86 | 82 mm | C7402 | \$37.19 | H2043027S | Head Gasket 82mm Bore | \$30.95 | 12251-HA0-003/004/005 |
| TRX350, D | 86-89 | 86 mm | C7405 | \$37.19 | H2044027S | Head Gasket 86mm Bore | \$30.95 | 12251-HA0-003/004/005 |
| | | | | | B0199020F | Base Gasket | \$9.94 | 12191-HA7-921 |
| | | | | | | | | |
| | | | | | Component Part# | Description | List Price | OEM Part# |
| | | | | | EC650032AFM | Clutch Cover Gasket | \$24.99 | 11394-HC4-840 |



MX/Dirt · Off-Road · ATV Gaskets



Cometic Gasket - An Exclusive NASCAR Performance® Product

TRX400EX

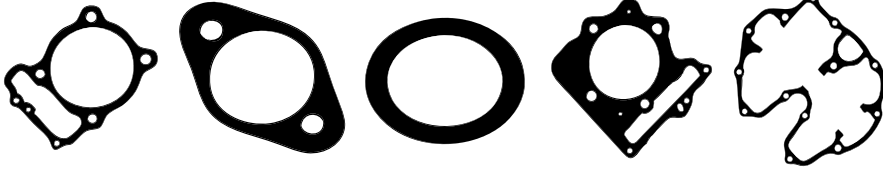

Base Timing Chain Tensioner Exhaust Head Valve Cover

| Model | Year | Bore Size | EST Top End Kit | List Price | Component Part# | Component Description | List Price | OEM Part # | | | |
|-----------|-------|-----------------------------------|-----------------|-------------------|-----------------------------|-------------------------------|------------------------------|------------------------|------------------------------|-------------------|-------------------|
| TRX400 EX | 96-04 | 86 mm | C7825-EST | \$80.99 | H0401027S | Head Gasket 86mm .027" | \$27.26 | 12251-KCY-671 | | | |
| | | 87 mm | C7924-EST | \$80.99 | H0401SP2027S | Head Gasket 87mm .027" | \$27.26 | | | | |
| | | 89 mm | C7826-EST | \$80.99 | H0402027S | Head Gasket 89mm .027" | \$27.26 | 12251-KCY-671 | | | |
| | | | | | B0244020RC | Base Gasket .020" | \$12.39 | 12191-KCY-671 | | | |
| | | | | | R88X2B | Cylinder Base O-ring | \$1.36 | 91302-356-000 | | | |
| | | | | | EX691064AM | Exhaust Gasket 2 Req. | \$4.20 | 18291-MN5-650 | | | |
| | | | | | EC578020RC | Cam Chain Tensioner Gasket | \$5.50 | 14523-KBB-901 | | | |
| | | | | | R10X2V | Valve Guide O-Ring | \$1.59 | 91301-200-000 | | | |
| | | | | | 3231V | Valve Seals 4 Req. | 6.48 ea. | 12209-KL4-005 | | | |
| | | | | | R011V | Cam Chain Tensioner O-ring | \$1.13 | 91306-MG3-000 | | | |
| | | | | | R127V | Valve Adj. Cap O-rings 4 Req. | \$3.92 | 91301-428-003 | | | |
| | | | | | R132V | Intake Manifold O-ring | \$1.19 | 91301-679-003 | | | |
| | | | | | R219V | Exhaust O-ring | \$3.92 | 18291-MN5-650 | | | |
| | | | | | R45.5X2.5V | Intake O-ring | \$2.34 | 91303-397-000 | | | |
| TRX400 EX | 99-04 | Bottom End Kit w/Oil Seals | | List Price | Component Part# | Component Description | List Price | OEM Part # | | | |
| | | | C7825BE | \$81.38 | EC362020F | Center Case Gasket | \$14.87 | 11191-HN1-000 | | | |
| | | | | | EC363020F | Starter Cover O-ring | \$2.38 | 11377-HN1-000 | | | |
| | | | | | WA129 | Oil Tank Drain Plug Washer | \$0.95 | 90441-425-000 | | | |
| | | | | | WA130 | Oil Pump Drain Washer | \$1.36 | 90463-ML7-000 | | | |
| | | | | | R18X3V | Oil Tank Dipstick O-ring | \$1.71 | 91302-KE8-003 | | | |
| | | | | | R54X2.5 | Oil Filter O-ring | \$11.34 | 91302-KF0-003 | | | |
| | | | | | R114B | Timing Mark O-ring | \$1.13 | 91303-377-000 | | | |
| | | | | | R214V | Oil Tank Strainer O-ring | \$1.19 | 91305-384-750 | | | |
| | | | | | R27X2V | Crank End O-ring | \$1.86 | 91305-KF0-003 | | | |
| | | | | | R013V | Oil line O-ring | \$1.08 | 91305-PE2-003 | | | |
| | | | | | R214V | Starter Motor O-ring | \$1.19 | 91312-MG7-003 | | | |
| | | | | | R112V | Oil line O-ring | \$1.19 | 91314-HN6-000 | | | |
| | | | | | WA137 | Drain Plug Washer | \$1.53 | 94109-12000 | | | |
| | | | | | MR049 | Oil Pump Gasket | \$6.74 | 15152-KCY-670 | | | |
| | | | | | Oil Seal Kit | | List Price | Component Part# | Component Description | List Price | OEM Part # |
| | | | | | | C7825BE | \$15.05 | OS236 | Oil Pump Seal | \$4.23 | 91201-KF0-003 |
| | | | | | | | | OS247 | Clutch Pushrod Oil Seal | \$3.31 | 91204-KK0-003 |
| | | | | | | | | OS254 | Shift Shaft Seal | \$3.57 | 91202-965-003 |
| | | | | | | | | OS257 | Output Shaft Seal | \$3.94 | 91203-KCY-671 |
| | | | | | Clutch & Mag Kit | | List Price | Component Part# | Component Description | List Price | OEM Part # |
| | | | | | | C7825OS | \$29.74 | EC344020F | Clutch Cover Gasket | \$14.87 | 11394-KCY-671 |
| | | | | | | | | EC361020F | Mag Cover Gasket | \$14.87 | 11395-KCY-671 |
| | | | | | | Component Part# | Component Description | List Price | OEM Part # | | |
| | | | | | | VC032010S | Valve Cover Gasket | \$31.86 | 12391-KCY-671 | | |



MX/Dirt · Off-Road · ATV Gaskets



Cometic Gasket - An Exclusive NASCAR Performance® Product

HONDA

| Model | Year | Bore Size | EST Top End Kit | List Price | Component Part# | Component Description | List Price | OEM Part # |
|---------|-------|-----------|---|-------------------------------|------------------------|-----------------------------------|-------------------|-------------------|
| TRX400 | 05-08 | 86 mm | C7825-EST | \$80.99 | H0401027S | Head Gasket 86mm .027" | \$27.26 | 12251-KCY-671 |
| EX | | 87 mm | C7924-EST | \$80.99 | H0401SP2027S | Head Gasket 87mm .027" | \$27.26 | |
| TRX400X | 09-14 | 89 mm | C7826-EST | \$80.99 | H0402027S | H0402027S 89mm Bore .027" | \$27.26 | 12251-KCY-671 |
| | | | | | B0244020RC | Base Gasket .020" | \$12.39 | 12191-KCY-671 |
| | | | | | R88X2B | Cylinder Base O-ring | \$1.36 | 91302-356-000 |
| | | | | | EX691064AM | Exhaust Gasket 2 Req. | \$4.20 | 18291-MN5-650 |
| | | | | | EC578020RC | Cam Chain Tensioner Gasket | \$5.50 | 14523-KBB-901 |
| | | | | | R10X2V | Valve Guide O-Ring | \$1.59 | 91301-200-000 |
| | | | | | 3231V | Valve Seals 4 Req. | \$6.48 ea. | 12209-KL4-005 |
| | | | | | R011V | Cam Chain Tensioner O-ring | \$1.13 | 91306-MG3-000 |
| | | | | | R127V | Valve Adjuster Cap O-rings 4 Req. | \$3.92 | 91301-428-003 |
| | | | | | R132V | Intake Manifold O-ring | \$1.19 | 91301-679-003 |
| | | | | | R219V | Exhaust O-ring | \$3.92 | 18291-MN5-650 |
| | | | | | R45.5X2.5V | Intake O-ring | \$2.34 | 91303-397-000 |
| | | | Bottom End Kit w/crank seals C3342 | List Price \$44.67 | Component Part# | Component Description | List Price | OEM Part # |
| | | | | | EC1222020F | Center Case Gasket | \$22.66 | 11191-HN1-A40 |
| | | | | | C7714 | Clutch Cover Gasket | \$14.87 | 11394-KCY-671 |
| | | | | | EC361020F | Mag Cover Gasket | \$14.87 | 11395-KCY-671 |
| | | | | | EC363020F | Starter Cover Gasket | \$2.38 | 11377-HN1-000 |
| | | | | | Component Part# | Description | List Price | OEM Part# |
| | | | | | VC032010S | Valve Cover Gasket | \$31.86 | 12391-KCY-671 |
| | | | EST Top End | List Price | Component Part# | Component Description | List Price | OEM Part # |
| XR400R | 96-05 | 86 mm | C7825-EST | \$80.99 | H0401027S | Head Gasket 86mm .027" | \$27.26 | 12251-KCY-671 |
| | | 89 mm | C7826-EST | \$80.99 | H0402027S | Head Gasket 89mm Bore .027" | \$27.26 | 12251-KCY-671 |
| | | | | | B0244020RC | Base Gasket .020" | \$12.39 | 12191-KCY-671 |
| | | | | | R88X2B | Cylinder Base O-ring | \$1.36 | 91302-356-000 |
| | | | | | EX691064AM | Exhaust Gasket 2 Req. | \$4.20 | 18291-MN5-650 |
| | | | | | EC578020RC | Cam Chain Tensioner Gasket | \$5.50 | 14523-KBB-901 |
| | | | | | R10X2V | Valve Guide O-Ring 4 Req. | \$1.59 | 91301-200-000 |
| | | | | | 3231V | Valve Seals 4 Req. | 6.48 ea. | 12209-KL4-005 |
| | | | | | R011V | Cam Chain Tensioner O-ring | \$1.13 | 91306-MG3-000 |
| | | | | | R127V | Valve Adjuster Cap O-rings 4 Req. | \$3.92 | 91301-428-003 |
| | | | | | R132V | Intake Manifold O-ring | \$1.19 | 91301-679-003 |
| | | | | | R219V | Exhaust O-ring | \$3.92 | 18291-MN5-650 |
| | | | | | R45.5X2.5V | Intake O-ring 2 Req. | \$2.34 | 91303-397-000 |
| | | | Bottom End Kit w/crank seals C3327 | List Price \$47.10 | Component Part# | Component Description | List Price | OEM Part # |
| | | | | | EC399060AFM | Clutch Cover Gasket | \$13.62 | 11394-KCY-671 |
| | | | | | EC238020F | Center Case Gasket | \$12.39 | 11191-KCY-670 |
| | | | | | EC361060AFM | Mag Cover Gasket | \$17.84 | 11395-KCY-671 |
| | | | | | Component Part# | Description | List Price | OEM Part# |
| | | | | | VC032010S | Valve Cover Gasket | \$31.86 | 12391-KCY-671 |

FOREMAN 400

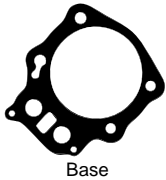

Base



Head

| Model | Year | Bore Size | Top End Kit | List Price | Component Part# | Component Description | List Price | OEM Part # |
|----------------|-------|-----------|-------------|------------|------------------------|-----------------------|-------------------|------------------|
| Fourtrax | 95-03 | 88 mm | C7301 | \$31.92 | H0434043F | Head Gasket | \$24.75 | 12251-HM7-004 |
| Foreman 400 | | 95 mm | C7644 | \$31.92 | H0877043F | 95mm Bore Head Gasket | \$28.51 | 12251-HM7-004 |
| | | | | | B0259020F | Base Gasket | \$6.25 | 12191-HM7-003 |
| | | | | | B0401020F | Big Bore Base Gasket | \$12.39 | 12191-HM7-003 |
| | | | | | Component Part# | Description | List Price | OEM Part# |
| | | | | | EC611020F | Clutch Cover Gasket | \$14.87 | 11394-HM7-003 |



MX/Dirt · Off-Road · ATV Gaskets



Cometic Gasket - An Exclusive NASCAR Performance® Product

CRF450

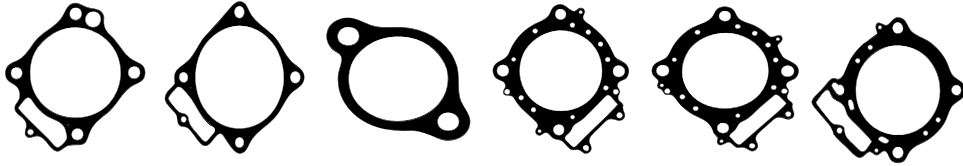

| Base Model | Base Year | Base Bore Size | Timing Chain Tensioner EST | Head List Price | Head Component Part# | Head Component Description | List Price | OEM Part # |
|-----------------------------------|-----------|----------------|----------------------------|-----------------|------------------------|-------------------------------|-------------------|-------------------|
| CRF450R | 02-08 | 96 mm | C3047-EST | \$72.75 | H1301027S | Head Gasket 96mm | \$31.15 | |
| | | 97 mm | C3554-EST | \$72.75 | H1301SP6027S | Head Gasket 97mm | \$31.15 | |
| | | 99 mm | C3049-EST | \$72.75 | H1394027S | Head Gasket 99mm | \$31.15 | |
| | | | | | B0548014RC | Base Gasket | \$13.47 | 12191-MEB-671 |
| | | | | | EX657 | Exhaust Gasket | \$9.37 | 18291-MEB-670 |
| | | | | | EC898018AFM | Cam Chain Tensioner Gasket | \$3.35 | 14560-KCW-851 |
| | | | | | R011V | Cam Chain Tensioner O-ring | \$2.56 | 91306-M63-000 |
| | | | | | 3231V | Exhaust Valve Seals 2 Req. | 6.48 ea. | 12209-GB4-681 |
| | | | | | 3234V | Intake Valve Seals 2 Req. | 5.50 ea. | 12209-KL4-005 |
| | | | | | R19X3V | Water Pipe O-ring | \$3.02 | 91312-KE7-003 |
| | | | | | R9.5X1.5V | Cam Chain Tensioner O-Ring | \$2.56 | 91306-MG3-000 |
| Bottom End Kit w/Oil Seals | | | List Price | | Component Part# | Component Description | List Price | OEM Part # |
| | | | C3047BE | \$92.60 | EC585020F | Center Case Gasket | \$19.82 | 11191-MEN-850 |
| | | | | | EC587020F | Inner Clutch Cover Gasket | 16.13 | 11394-MEB-670 |
| | | | | | WP166 | Water Pump Cover O-ring | \$4.05 | 19226-MEB-670 |
| | | | | | WA128 | Water Pump Drain Crush Seal | \$1.59 | 90463-ML7-000 |
| | | | | | WA128 | Water Pump Drain Crush Washer | \$1.59 | 90463-ML7-000 |
| | | | | | WA135 | Mag Cover Crush Seal | \$0.80 | 90474-333-000 |
| | | | | | R8.5X2V | Oil Relief Valve O-ring | \$1.10 | 90751-GK1-003 |
| | | | | | R110V | Inner Clutch Cover O-ring | \$1.19 | 91256-383-721 |
| | | | | | R40X2V | Oil Filter O-ring | \$2.82 | 91302-PA9-003 |
| | | | | | R114B | Timing Mark O-ring | \$1.13 | 91303-377-000 |
| | | | | | R27X2V | Right Case Plug O-ring 27x2 | \$1.86 | 91305-KF0-003 |
| | | | | | R18X3V | Fill Plug O-ring | \$1.71 | 91307-035-000 |
| | | | | | R18X3V | Fill Plug O-ring | \$1.71 | 91307-035-000 |
| Oil Seal Kit | | | List Price | | Component Part# | Component Description | List Price | OEM Part # |
| | | | C3047OS | \$45.45 | OS227 | Inner Water Pump Shaft Seal | \$2.67 | 91201-965-000 |
| | | | | | OS236 | Shift Shaft Seal | \$4.23 | 91203-KA4-771 |
| | | | | | OS238 | Output Shaft Seal | \$3.17 | 91207-ML3-871 |
| | | | | | OS239 | Start Shaft Seal | \$2.60 | 91204-KF0-003 |
| | | | | | OS240 | Clutch Pushrod Seal | \$2.43 | 91205-MEB-671 |
| | | | | | OS261 | Balancer Shaft Seal | \$2.64 | 91203-MEB-671 |
| | | | | | OS262 | Mag Seal | \$2.60 | 91204-HP1-601 |
| | | | | | OS264 | Left Crank Seal | \$10.97 | 91201-MEB-671 |
| | | | | | OS266 | Right Crank Seal | \$10.97 | 91202-MEY-671 |
| | | | | | OS242 | Impeller Shaft Seal | \$3.17 | 91211-MEN-A01 |
| Clutch & Mag Kit | | | List Price | | Component Part# | Component Description | List Price | OEM Part # |
| | | | C3047CM | \$29.75 | EC765060AFM | Clutch Cover Replaces O-ring | \$13.62 | 11352-MEB-671 |
| | | | | | EC586060AFM | Mag Cover Gasket | \$16.13 | 11352-MEB-671 |
| | | | | | Component Part# | Description | List Price | OEM Part# |
| | | | | | VC100 | Valve Cover Gasket | \$15.44 | 12391-MEB-670 |



MX/Dirt · Off-Road · ATV Gaskets



Cometic Gasket - An Exclusive NASCAR Performance® Product

HONDA

| Model | Year | Bore Size | EST | List Price | Component Part# | Component Description | List Price | OEM Part # | |
|-----------------------------------|-------|-----------|--------------------|--------------|----------------------------------|------------------------------|---------------------------------|-------------------|--|
| CRF450R | 09-16 | 96mm | Top End Kit | | | | | | |
| | | | C3270-EST | \$89.38 | H2856027S | Head Gasket 97.5mm Stock | \$43.39 | 12251-MEN-A31 | |
| | | | C3275-EST | \$89.38 | H2856SP1027S | Head Gasket 98.5mm | \$43.39 | | |
| | | 98mm | | | | | | | |
| | | | C3276-EST | \$89.38 | H2856SP3027S | Head Gasket 100mm | \$43.39 | | |
| | | | | | B0969010RC | Base Gasket | \$15.72 | 12191-MEN-A31 | |
| | | 100mm | | | | | | | |
| | | | | | EX657 | Exhaust Gasket | \$9.37 | 18291-MEB-670 | |
| | | | | | EC960018AFM | Cam Chain Tensioner Gasket | \$3.35 | 14560-MEN-671 | |
| | | | | | 3234V | Valve Seals | 5.50 ea. | 12209-GB4-682 | |
| | | | | | R19X3V | Water Pipe O-ring | \$3.02 | 91312-KE7-003 | |
| | | | | | R22X2.5V | Cylinder Water Outlet O-ring | \$2.21 | 91355-759-003 | |
| | | | | | EX657 | Exhaust Gasket | \$9.37 | 18291-MEB-670 | |
| Bottom End Kit w/Oil Seals | | | | | | | | | |
| | | | List Price | | Component Part# | Component Description | List Price | OEM Part # | |
| | | C3270BE | \$93.96 | WA135 | Drain Plug Washer | \$0.80 | 90474-333-000 | | |
| | | | | EC1415020F | Center Crankcase Gasket | \$19.82 | 11191-MEN-A30 | | |
| | | | | R16X3V | Neutral Switch O-ring | \$1.26 | 91305-KC1-850 | | |
| | | | | R40X2V | Oil Filter Cover Gasket | \$3.74 | 91302-035-000/ 91302-PA9-003 | | |
| | | | | R14X2.5V | Timing Plug O-ring | \$1.13 | 91303-377-000 | | |
| | | | | R18X3V | Dipstick O-ring | \$1.71 | 91307-035-000 | | |
| | | | | R8.5X1.5V | Oil Pressure Relief Valve O-ring | \$1.13 | 90751-GK1-003 | | |
| | | | | EC1414018AFM | Inner Clutch Cover Gasket | \$19.82 | 11394-MEN-A30 | | |
| | | | | | Water Pump Cover Gasket | \$3.43 | 19226-MEN-A30 | | |
| | | | | R27X2V | Right Case Plug O-ring | \$1.86 | 91305-KF0-003 | | |
| | | | | R27X2V | Clutch Oil Fill Plug O-ring | \$1.86 | 91307-035-000 | | |
| Oil Seal Kit | | | | | | | | | |
| | | | List Price | | Component Part# | Component Description | List Price | OEM Part # | |
| | | C3270OS | \$38.90 | OS264 | Left Crank Seal 38x52x7 | \$8.48 | 91201-MEB-671 | | |
| | | | | OS236 | Shift Shaft Oil Seal 14x22x5 | \$2.56 | 91203-KA4-771 | | |
| | | | | OS240 | Clutch Actuator Oil Seal 12x18x3 | \$2.31 | 91205-MEB-671 | | |
| | | | | OS262 | Crank End Oil Seal 10x21x5 | \$2.60 | 91204-MEN-A31 | | |
| | | | | OS239 | Kickstart Shaft Seal 20x28x5 | \$4.37 | 91204-KF0-003 | | |
| | | | | OS227 | Water Pump Seal 12x22x5 | \$2.81 | 91201-965-000 | | |
| | | | | OS238 | Output Shaft Seal 31x40x7 | \$6.90 | 91207-ML3-871 | | |
| Clutch & Mag Kit | | | | | | | | | |
| | | | List Price | | Component Part# | Component Description | List Price | OEM Part # | |
| | | C3270CM | \$29.75 | EC1416032AFM | Generator Cover Gasket | \$16.13 | 11395-MEN-A30 | | |
| | | | | EC978 | Outer Clutch Cover O-ring | \$5.87 | 11352-MEB-671 | | |



MX/Dirt • Off-Road • ATV Gaskets



Cometic Gasket - An Exclusive NASCAR Performance® Product

HONDA

| | EST | List Price | Component Part# | Component Description | List Price | OEM Part # |
|---------------|-----------------------------------|------------|------------------------|----------------------------------|-------------------|------------------|
| CRF450X 05-15 | 96 mm | | | | | |
| | 98mm | | | | | |
| | 99mm | | | | | |
| | Top End Kit | | | | | |
| | C3134-EST | \$89.38 | H2458027S | Head Gasket 96mm Bore | \$37.39 | 12251-MEY-671 |
| | C3556-EST | \$89.38 | H2458SP1027S | Head Gasket 98mm Bore | \$37.39 | |
| | C3557-EST | \$89.38 | H2459027S | Head Gasket 99mm Bore | \$37.39 | |
| | | | 3231V | Exhaust Valve Seals 2 Req. | \$6.48 ea. | 12209-GB4-681 |
| | | | 3234V | Intake Valve Seals 2 Req. | \$5.50 ea. | 12209-KL4-005 |
| | | | B0891020RC | Base Gasket | \$20.99 | 12191-MEB-671 |
| | | | EC960018AFM | Cam Chain Tensioner Gasket | \$3.35 | 14560-MEN-671 |
| | | | EX657 | Exhaust Gasket | \$9.37 | 18291-MEB-670 |
| | | | R117B | Water Outlet O-ring | \$0.42 | 91312-KE7-003 |
| | | | Component Part# | Description | List Price | OEM Part# |
| | | | VC100 | VC100 Valve Cover Gasket | \$15.44 | 12391-MEB-670 |
| | Bottom End Kit w/Oil Seals | | | | | |
| | C3134BE | \$92.60 | EC1064020F | Center Case Gasket | \$10.56 | 11191-MEY-671 |
| | | | R8.5X1.5V | Oil Relief O-Ring | \$1.13 | 90751-GK1-003 |
| | | | R40X2V | Oil Filter O-Ring | \$2.82 | 91302-PA9-003 |
| | | | R14X2.5V | Timing Mark O-ring | \$1.13 | 91303-377-000 |
| | | | R18X3V | Dipstick O-ring | \$1.71 | 91307-377-000 |
| | | | WA135 | Left Cover Drain Washer | \$0.80 | 90474-333-000 |
| | | | EC1065018AFM | Inner Clutch Cover | \$14.25 | 11394-MEY-671 |
| | | | R18X3V | Trans Fill Plug O-ring | \$1.71 | 91307-035-000 |
| | | | R18X2.5V | Water Galley O-ring | \$1.71 | 91256-383-721 |
| | | | WA118 | Right Case Drain Seal | \$1.88 | 90463-ML7-000 |
| | | | R27X2V | Crank End Plug O-ring | \$1.86 | 91305-KF0-003 |
| | | | R22X2.5V | Water Outlet O-ring | \$2.21 | 91355-759-003 |
| | | | WP166 | Water Pump Gasket | \$4.05 | 19226-MEB-670 |
| | | | WA128 | Water Pump Drain Gasket | \$1.59 | 90463-ML7-000 |
| | Oil Seal Kit | | | | | |
| | C3134OS | 42.28 | OS266 | Right Crank Seal 39X56X7.5 | \$10.97 | 91202-MEY-671 |
| | | | OS240 | Clutch Pushrod Seal 12x18x3 | \$2.43 | 91205-MEB-671 |
| | | | OS264 | Left Crank Seal 38x52x7 | \$10.97 | 91201-MEB-671 |
| | | | OS261 | Balancer Seal 20x33x5 | \$2.64 | 91203-MEB-671 |
| | | | OS236 | Shift Shaft Seal 14x22x5 | \$4.23 | 91203-KA4-771 |
| | | | OS262 | Left Case Cover Oil Seal 10X21X5 | \$2.60 | 91204-KRN-671 |
| | | | OS239 | Start Shaft Oil Seal 20x28x5 | \$2.60 | 91204-KF0-003 |
| | | | OS238 | Output Shaft Seal 31x40x7 | \$3.17 | 91207-ML3-871 |
| | | | OS227 | Water Pump Seal 12X22X5 | \$2.67 | 91201-148-003 |
| | Clutch & Mag Kit | | | | | |
| | C3134CM | \$13.20 | EC978 | Clutch Cover O-ring | \$5.87 | 11352-MEB-671 |
| | | | EC586032AFM | Mag Cover Gasket | \$7.33 | 11352-MEB-671 |



MX/Dirt · Off-Road · ATV Gaskets



Cometic Gasket - An Exclusive NASCAR Performance® Product

TRX450R

| Model | Year | Bore Size | EST | List Price | Component Part# | Component Description | List Price | OEM Part # | | | |
|-------------|-------|-----------|--------------------|------------|----------------------------|--------------------------------------|------------------------|-------------------------------|--------------------|-------------------|------------------|
| TRX450R | 04-05 | 94 mm | Top End Kit | | C7877-EST | \$72.75 | H2175027S | 94mm Bore Head Gasket | \$31.15 | 12251-HP1-671 | |
| | | | C7199-EST | \$72.75 | H2084027S | 95mm Bore Head Gasket | \$31.15 | 12251-HP1-671 | | | |
| | | | C7878-EST | \$72.75 | H2084SP1027S | 96mm Bore Head Gasket | \$31.15 | 12251-HP1-671 | | | |
| | | | C7201-EST | \$72.75 | H2129027S | 97mm Bore Head Gasket | \$31.15 | 12251-HP1-671 | | | |
| | | | C3079-EST | \$72.75 | H2131SP2027S | 100mm Bore Head Gasket | \$31.15 | 12251-HP1-671 | | | |
| | | | C3076-EST | \$72.75 | H2131SP1027S | 101mm Bore Head Gasket | \$31.15 | 12251-HP1-671 | | | |
| | | | | | B0741014RC | Base Gasket | \$13.47 | 12191-HP1-671 | | | |
| | | | | | B0741SP1014RC | Big Bore Base Gasket 99mm and Larger | \$13.47 | 12191-HP1-671 | | | |
| | | | | | EX657 | Exhaust Gasket | \$9.37 | 4BE-14613-00-00 | | | |
| | | | | | EC979032AFM | Cam Chain Tensioner Gasket | \$3.12 | 14523-MAL-A00 | | | |
| | | | | | MA0164 | Tensioner Bolt Washer | \$0.93 | 90442-397-000 | | | |
| | | | | | 3231V | Valve Seals 4 Req. | \$6.48 ea. | 12209-KL4-005 | | | |
| | | | | | R45.5X2.5V | Thermostat Cover O-ring | \$2.34 | 91373-733-003 | | | |
| | | | | | Bottom End Kit | | List Price | Component Part# | Description | List Price | OEM Part# |
| | | | | | C3331 | \$54.99 | EC982032AFM | Inner Clutch Cover Gasket | \$17.84 | 11394-HP1-670 | |
| | | | | | | | EC981032AFM | Mag Cover Gasket | \$15.44 | 11395-HP1-670 | |
| | | | | | | | EC980020F | Center Case Gasket | \$12.83 | 11191-HP1-670 | |
| | | | | | | | MA0165 | Crankcase Oil Drain Washer | \$0.81 | 90474-333-000 | |
| | | | | | | | R10X2V | Breather Joint O-Ring | \$1.59 | 91304-HA5-003 | |
| | | | | | | | R14X2.5V | Timing Mark Sight Plug O-ring | \$1.13 | 91303-377-000 | |
| | | | | | | | R18X2.5V | Inner Clutch Dowel O-ring | \$1.71 | 91256-383-721 | |
| | | | | | | | R18X3V | Trans./Engine Oil Fill Plug | \$1.71 | 91307-035-000 | |
| | | | | | | | R27X2V | O-rings 2 Req. | \$1.86 | 91305-KF0-003 | |
| | | | | | | | R40X2V | Inner Clutch Plug O-ring | \$2.82 | 91302-PA9-003 | |
| | | | | | | | R8.5X2V | Oil Filter Cover O-ring | \$1.10 | 90751-GK1-003 | |
| | | | | | | | WA128 | Relief Valve O-ring | \$1.59 | 90463-ML7-000 | |
| | | | | | | | Component Part# | Description | List Price | OEM Part# | |
| | | | | VC101 | Crush Washer Case Oil Seal | \$15.44 | 12391-HP1-670 | | | | |
| TRX450R, ER | 06-14 | 96 mm | Top End Kit | | C3139-EST | \$80.99 | H2458027S | 96mm Bore Head Gasket | \$37.39 | 12251-MEY-671 | |
| | | | C3141-EST | \$80.99 | H2458SP1027S | 98mm Bore Head Gasket | \$37.39 | | | | |
| | | | C3272-EST | \$80.99 | H2459027S | 99mm Bore Head Gasket | \$37.39 | | | | |
| | | | C3156-EST | \$80.99 | H2460027S | 101mm Bore Head Gasket | \$37.39 | | | | |
| | | | | | B0856014RC | Base Gasket | \$13.47 | 12191-HP1-601 | | | |
| | | | | | EX657 | Exhaust Gasket | \$9.37 | 18291-MEB-670 | | | |
| | | | | | EC960018AFM | Cam Chain Tensioner Gasket | \$3.35 | 14560-MEN-671 | | | |
| | | | | | EC979032AFM | Cam Chain Tensioner Gasket | Early\$3.12 | 14523-MAL-A00 | | | |
| | | | | | 3231V | Exhaust Valve Seals 2 Req. | 6.48 ea. | 12209-KL4-005 | | | |
| | | | | | 3234V | Intake Valve Seals 2 Req. | 5.50 ea. | 12209-GB4-682 | | | |
| | | | | | MA0164 | Cam Chain Tensioner Bolt Seal | \$0.93 | 90442-397-000 | | | |
| | | | | | R45.5X2.5V | Thermostat Housing Gasket | \$2.34 | 91373-733-003 | | | |
| | | | | | Bottom End Kit | | List Price | Component Part# | Description | List Price | OEM Part# |
| | | | | | C3139BE | \$92.60 | WA118 | Case Seal Crush Washer 8 Req. | \$1.88 | 90488-425-000 | |
| | | | | | | | EC1134020F | Center Case Gasket | \$12.83 | 11191-HP1-600 | |
| | | | | | | | EC978 | Clutch Cover O-ring | | 11352-HP1-670 | |
| | | | | | | | EC1133032AFM | Inner Clutch Cover Gasket | \$17.84 | 11394-HP1-600 | |
| | | | | | | | EC1223032AFM | Mag Cover Gasket | \$16.13 | 11395-HP1-600 | |
| | | | | | | | WA111 | Water Pump Crush Washer | \$0.80 | 90447-KE1-000 | |
| | | | | | | | R8X2V | Relief Valve O-ring | \$1.13 | 90751-GK1-003 | |
| | | | | | | | R18X2.5V | Case Dowel O-ring | \$1.71 | 91256-383-721 | |
| | | | | | | | R40X2V | Oil Filter O-ring | \$2.82 | 91302-PA9-003 | |
| | | | | | | | R14X2.5V | Timing Plug O-ring | \$1.13 | 91303-377-000 | |
| | | | | | | | R27X2V | Right Case Plug O-ring | \$1.86 | 91305-KF0-003 | |
| | | | | | | | R18X3V | Fill Plug O-rings 2 Req | \$1.71 | 91307-035-000 | |
| | | | | | | | WA137 | Drain Plug Gasket | \$1.53 | 94109-12000 | |
| | | | | | | | Component Part# | Description | List Price | OEM Part# | |
| | | | | OS292 | Right Crank Seal | \$10.68 | 91202-HP1-601 | | | | |
| | | | | OS262 | Balancer Shaft Seal | \$2.60 | 91204-HP1-601 | | | | |
| | | | | OS264 | Left Crank Seal | \$10.97 | 91201-MEB-671 | | | | |
| | | | | OS227 | Shift Shaft Seal | \$2.67 | 91203-KA4-771 | | | | |
| | | | | OS289 | Oil Pump Seal | \$4.49 | 91203-HP1-601 | | | | |
| | | | | OS239 | Start Shaft Seal | \$2.60 | 91204-KF0-003 | | | | |
| | | | | OS240 | Clutch Pushrod Seal | \$2.43 | 91205-MEB-671 | | | | |
| | | | | OS238 | Output Shaft Seal | \$3.17 | 91207-ML3-871 | | | | |

All Component Parts can be purchased individually.



MX/Dirt · Off-Road · ATV Gaskets



Cometic Gasket - An Exclusive NASCAR Performance® Product

CR480

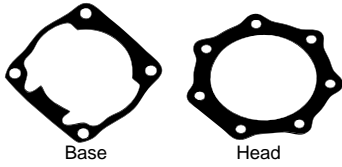

| Model | Year | Bore Size | Top End Kit | List Price | Component Part# | Component Description | List Price | OEM Part # |
|-------|-------|-----------|-------------|------------|-----------------|-----------------------|------------|-------------------------------------|
| CR480 | 82-83 | 91 mm | C7017 | \$27.65 | H0011020C | 91mm Head Gasket | \$25.73 | 12254-KA5-770 |
| | | | | | B0015020F | Base Gasket | \$6.25 | 12191-MA0-000 |
| | | | | | Component Part# | Component Description | List Price | OEM Part # |
| | | | | | EC801032AFM | Clutch Cover Gasket | \$14.93 | 31129-KA4-000/ 11395-KA4-000/306 |

XL/XR500

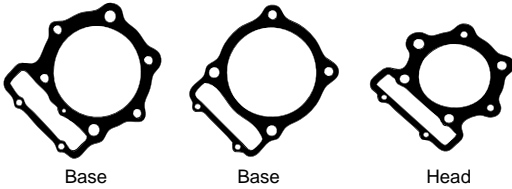

| Model | Year | Bore Size | Top End Kit | List Price | Component Part# | Component Description | List Price | OEM Part # |
|-------|-------|-----------|-------------|------------|-----------------|-----------------------|------------|---------------|
| XL500 | 79-82 | 91 mm | C7147 | \$31.91 | H0265043F | 91mm Head Gasket | \$20.99 | 06130-MC4-000 |
| XR500 | 79-82 | 95 mm | C7148 | \$31.91 | H0260043F | 95mm Head Gasket | \$24.75 | 06130-MC4-000 |
| | | | | | B0173020F | Base Gasket | \$9.94 | 12191-MA0-306 |
| | | | | | Component Part# | Component Description | List Price | Part# |
| | | | | | EC401032AFM | Clutch Cover Gasket | \$12.39 | 11394-MN1-700 |
| | | | Top End Kit | List Price | Component Part# | Component Description | List Price | OEM Part # |
| XR500 | 83-84 | 93 mm | C7238 | \$31.91 | B0205020F | Base Gasket | \$7.16 | 12191-MN1-700 |
| | | | | | H0257043F | Head Gasket 93mm Bore | \$27.26 | 12251-MK4-602 |
| | | | | | Component Part# | Component Description | List Price | OEM Part # |
| | | | | | EC401032AFM | Clutch Cover Gasket | \$12.39 | 11394-MN1-700 |

HONDA CR500

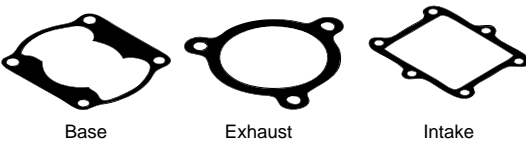

| Model | Year | Bore Size | Top End Kit | List Price | Component Part# | Component Description | List Price | OEM Part # |
|-------|-------|-----------|-------------|--|-----------------|------------------------------------|------------|---------------|
| CR500 | 84 | 91 mm | C7018 | \$48.44 | B0016020F | Base Gasket | \$7.16 | 12191-ML3-790 |
| | | | | | H0011020C | Head Gasket | \$25.73 | 12254-KA5-770 |
| | | | | | IR006018AFM | Intake Gasket | \$3.80 | 14132-KA5-740 |
| | | | | | Component Part# | Component Description | List Price | OEM Part # |
| | | | | | C7490 | Clutch Cover Gasket | \$11.47 | 91311-KS7-701 |
| | | | Top End Kit | List Price | Component Part# | Component Description | List Price | OEM Part # |
| CR500 | 85-88 | 91 mm | C7019 | \$42.13 | H0012043F | Head Gasket | \$22.32 | 12254-ML3-881 |
| | | | | | B0016020F | Base Gasket | \$7.16 | 12191-ML3-790 |
| | | | | | IR006018AFM | Intake Gasket | \$3.80 | 14132-KA5-740 |
| | | | | | EX009042AM | Exhaust Gasket | \$4.65 | 18291-ML3-791 |
| | | | | | Component Part# | Component Description | List Price | OEM Part # |
| | | | | | C7490 | Clutch Cover Gasket | \$11.47 | 91311-KS7-701 |
| | | | Top End Kit | List Price | Component Part# | Component Description | List Price | OEM Part # |
| CR500 | 89-01 | 91 mm | C7020 | \$42.13 | H0300010S | Head Gasket | \$30.95 | 12254-ML3-680 |
| | | | | | B0017018AFM | Base Gasket | \$9.32 | 12191-MAC-680 |
| | | | | | B0017012F | High Compression Base Gasket .012" | \$9.32 | \$9.32 |
| | | | | | IR006018AFM | Intake Gasket | \$3.80 | 14132-KA5-740 |
| | | | | | EX009042AM | Exhaust Gasket | \$4.65 | 18291-ML3-791 |
| | | | | | Component Part# | Component Description | List Price | OEM Part # |
| | | | | | C7490 | Clutch Cover Gasket | \$11.47 | 91311-KS7-701 |
| CR500 | 84-88 | Part # | List Price | Description | | | | |
| | | C7772 | \$67.99 | Special 5mm Base Kit for 89-01 Connecting Rod. Includes Shim and 2 Base Gaskets for use with 89-01 Rod in 84-88 Engines. | | | | |



MX/Dirt · Off-Road · ATV Gaskets



Cometic Gasket - An Exclusive NASCAR Performance® Product

XL/XR600 XR650R

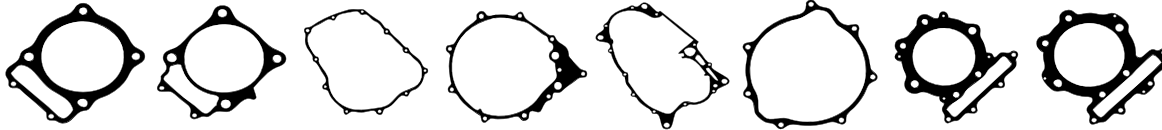

| Model | Year | Base Bore Size | Inner Clutch Cover Top End Kit | Mag Cover List Price | Center Cover Component Part# | Outer Clutch Cover Component Description | Head List Price | Head OEM Part # | | | | |
|--------|-------|---|--------------------------------|-----------------------|---------------------------------|--|-----------------------|--------------------------------|---------------------------------|---|-----------------------|-----------------------------|
| XL600 | 83-87 | 103 mm | C7149 | \$31.91 | H0270SP3040S B0145020F | Head Gasket Base Gasket | \$24.75 \$9.32 | 12251-MG2-004 12191-MN1-700 | | | | |
| XR600 | 88-00 | 98 mm 100 mm 101 mm 102 mm 103 mm | Top End Kit C7827 | List Price \$38.33 | Component Part# H0239030S | Component Description Head Gasket 98mm Bore | List Price \$29.19 | OEM Part # 12251-MN1-671 | | | | |
| | | | | | | | | | Component Part# H1407030S | Component Description Head Gasket 100mm Bore | List Price \$29.19 | OEM Part # 12251-MN1-671 |
| | | | | | | | | | Component Part# H0317030S | Component Description Head Gasket 101mm Bore | List Price \$29.19 | OEM Part # 12251-MN1-671 |
| | | | | | | | | | Component Part# H0317SP2030S | Component Description Head Gasket 102mm Bore | List Price \$29.19 | OEM Part # 12251-MN1-671 |
| | | | | | | | | | Component Part# H0221030S | Component Description Head Gasket 103mm Bore | List Price \$29.19 | OEM Part # 12251-MN1-671 |
| | | | | | | | | | Component Part# B0145020F | Component Description Base Gasket | List Price \$9.32 | OEM Part # 12191-MN1-700 |
| | | | | | | | | | Component Part# EC401032AFM | Component Description Clutch Cover | List Price \$12.39 | OEM Part # 11394-MN1-700 |
| | | | | | | | | | Component Part# EC402060AFM | Component Description Mag Cover Gasket | List Price \$12.39 | OEM Part # 11352-MN1-680 |
| | | | | | | | | | Component Part# EC403020F | Component Description Center Case Gasket | List Price \$12.39 | OEM Part # 11191-MN1-700 |
| | | | | | | | | | Component Part# VC031010S | Component Description Valve Cover Gasket | List Price \$33.17 | OEM Part # 12391-MG2-790 |
| XR650L | 93-12 | 103 mm | Top End Kit C3216 | List Price \$31.91 | Component Part# H1675SP3030S | Component Description 103mm Head Gasket | List Price \$37.42 | OEM Part # 12251-MN9-742 | | | | |
| | | | | | | | | | Component Part# B0145020RC | Component Description Base Gasket | List Price \$12.39 | OEM Part # 12191-MN1-700 |
| | | | | | | | | | Component Part# EC619032AFM | Component Description Clutch Cover Gasket | List Price \$12.39 | OEM Part # 11394-MY2-621 |
| XR650R | 00-07 | 101 mm 103 mm | Top End Kit C7681 | List Price \$38.33 | Component Part# B0462020F | Component Description Base Gasket | List Price \$9.32 | OEM Part # 12191-MBN-670 | | | | |
| | | | | | | | | | Component Part# H0983018S | Component Description 101mm Bore Head Gasket | List Price \$30.95 | OEM Part # 12251-MBN-671 |
| | | | | | | | | | Component Part# H1047018S | Component Description 103mm Bore Head Gasket | List Price \$30.95 | OEM Part # 12251-MBN-671 |
| | | | | | | | | | Component Part# EC891060AFM | Component Description Clutch Cover Gasket | List Price \$15.44 | OEM Part # 11352-MBN-671 |

TRX680FA



| Model | Year | Base Bore Size | Valve Cover EST Top End Kit | List Price | Component Part# | Component Description | List Price | OEM Part # |
|----------|-------|----------------|-----------------------------|------------|-----------------|-----------------------|------------|---------------|
| TRX680FA | 06-16 | 102 mm | C3475-EST | \$68.71 | VC080020RC | Valve Cover Gasket | \$23.80 | 12315-HN8-000 |
| | | | | | R57X2V | Tappet Cover Gasket | \$11.41 | 91308-500-000 |
| | | | | | H1835027S | Cylinder Head Gasket | \$39.36 | 12251-HN8-A61 |
| | | | | | B0665010S | Cylinder Base Gasket | \$15.29 | 12191-HN8-000 |
| | | | | | EX651 | Exhaust Gasket | \$8.63 | 18291-MM5-860 |
| | | | | | 3231V | Valve Stem Seal | \$6.48 | 12209-KL4-005 |
| | | | | | EC036032AFM | Cam Chain Tensioner | \$1.96 | 12194-HC5-740 |
| | | | | | R9.5X1.5V | Rocker Arm O-rings | \$2.46 | 91306-MG3-000 |

TRX700XX



| Model | Year | Base Bore Size | Cam Chain EST Top End Kit | List Price | Component Part# | Component Description | List Price | OEM Part # |
|----------|-------|------------------|---------------------------|--------------------|-----------------|-------------------------|------------|---------------|
| TRX700XX | 08-09 | 102 mm 104 mm | C3420-EST C3286-EST | \$71.71 \$71.71 | H3025SP3027S | Head Gasket 102 mm Bore | \$43.39 | 12251-HP6-A01 |
| | | | | | H3025027S | Head Gasket 104 mm Bore | \$43.39 | |
| | | | | | R119B | Water Outlet Oring | \$1.04 | 91356-169-003 |
| | | | | | R5.7X1.9B | Dowel Pin O-ring | \$2.14 | 91305-323-000 |
| | | | | | B1012020RC | Base Gasket | \$9.47 | 12191-HP6-A01 |
| | | | | | EC898018AFM | Cam Chain | \$3.35 | 14560-KCW-851 |
| | | | | | 3225V | Valve Seals 4 Req. | \$1.76 ea. | 12209-413-003 |
| | | | | | EX657 | Exhaust Gasket | \$9.37 | 18291-MEB-670 |

All Component Parts can be purchased individually.



MX/Dirt · Off-Road · ATV Gaskets



Cometic Gasket - An Exclusive NASCAR Performance® Product

HUSABERG



Base

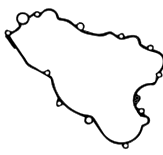

Inner Clutch

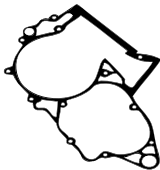

Center Case

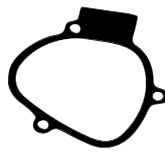

Power Valve

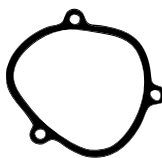

Power Valve

| Model | Year | Bore Size | Top End Kit | List Price | Component Part# | Component Description | List Price | OEM Part # |
|-------|-------|-----------|-----------------------|-------------------|------------------------|--|-------------------|------------------|
| TE250 | 11-13 | O-Ring | C3222 | \$38.33 | WA135 | Head Seal Crush Washer 6 Req. | \$0.77 | 56530080000 |
| TE300 | 11-13 | | | | R78X2V | Inner Head O-ring 78,00X2,00 | \$11.41 | 0770078020 |
| | | | | | R105X2B | Outer Head O-ring 105,00X2,00 | \$11.41 | 0770105020 |
| | | | | | PV136032AFM | Left Side Power Valve Gasket | \$4.54 | 54837006000 |
| | | | | | R11.5X2.5B | Front Power Valve Orings 4 Req. | \$0.94 | 0770116241 |
| | | | | | R44X3S | Exhaust O-rings 44,00X3,00 | \$2.71 | 0770440030 |
| | | | | | PV137032AFM | Right Side Power Valve | \$4.81 | 54837008000 |
| | | | | | B0666018AFM | Base Gasket.018" (0,4mm) | \$6.01 | 54830030004 |
| | | | | | R15X1.5V | Power Valve Control O-ring 15x1.5 | \$1.09 | 0770150151 |
| | | | | | R16X2V | Control Valve O-ring (300) 16x2 | \$2.90 | 0770160021 |
| | | | | | R114V | Power Valve Control Cap O-ring 12,37X2,62 | \$1.14 | 0770021120 |
| | | | | | R24X2V | Power Valve Control Guide O-ring 24,00X2,00 NBR70 | \$5.95 | 0770240020 |
| | | | Bottom End Kit | List Price | Component Part# | Component Part# | List Price | OEM Part# |
| | | | C3539 | \$101.61 | | Intake Gasket | \$4.09 | 54830062200 |
| | | | | | EC779020F | Center Case Gasket | \$23.80 | 54830039000 |
| | | | | | EC778032AFM | Clutch Cover Gasket | \$14.87 | 54830024000 |
| | | | | | R19X3V | Clutch Fill Plug O-ring 19,00X3,00 NBR | \$3.02 | 0770191015 |
| | | | | | R0049 | Outer Clutch Cover O-ring | \$15.72 | 54830025000 |
| | | | | | WA137 | Drain Plug Washer 12X18X1,5 | \$1.53 | 58038022000 |
| | | | | | R0050 | Water Pump Cover O-ring MR | \$11.30 | 54835003000 |
| | | | | | WA129 | Water Pump Drain Crush Washer 10x14x1 | \$0.95 | 0603100141 |
| | | | | | R25X1.5V | Crank O-ring 25x1.5 | \$6.19 | 0770250015 |
| | | | | | WA129 | Copper Crush Gasket Clutch Line 2 Req. 10X14X1 | \$0.95 | 0603100141 |
| | | | | | R30X1.5V | Slave Cylinder O-Ring 30,00X1,50 | \$2.29 | 0770300015 |
| | | | | | R25X2V | Output Shaft O-ring 25,00X2,00 | \$3.21 | 0770250020 |
| | | | | | R027V | Thermostat O-ring 32x2 | \$3.57 | 0770320020 |
| | | | | | EC1254032AFM | Ignition Cover Gasket | \$9.79 | 55130040000 |
| | | | | | EC1927018AFM | Outer Ignition Cover (Estart) | \$6.74 | 55130041100 |
| | | | | | R25X3V | Estart O-ring 25,00X3,00 | \$2.90 | 0770250030 |



MX/Dirt · Off-Road · ATV Gaskets



Cometic Gasket - An Exclusive NASCAR Performance® Product

HUSQVARNA CR/WR125

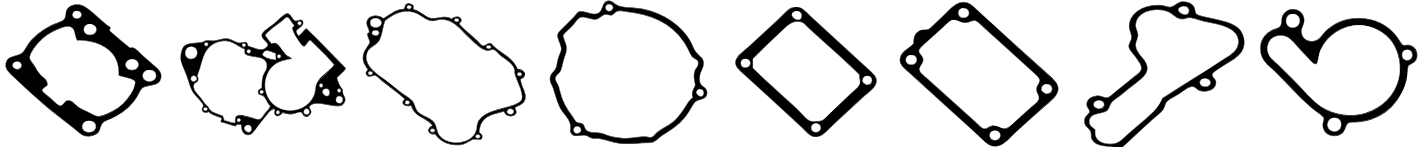

| Model | Year | Bore Size | Top End Kit | List Price | Component Part# | Component Description | List Price | OEM Part # |
|-------|-------|-----------|---------------------------------------|-------------------|------------------------|---------------------------------------|-------------------|------------------|
| CR/WR | 97-12 | O-Ring | C7734 | \$24.02 | R038V | Inner Head O-Ring | \$1.14 | |
| WR125 | 97-12 | | | | R044S | Outer Head O-Ring | \$3.77 | 8000 94652 |
| | | | | | B0445018AFM | Base Gasket | \$5.95 | 8B00 83068 |
| | | | | | WA116 | Head Crush Washers 5 Req. | \$1.06 | 8000 39335 |
| | | | | | R49X2.5V | Power Valve Cover O-ring | 3.14 | 8000 28553 |
| | | | | | R019V | Right Side Power Valve Housing O-ring | \$0.57 | 8000 19789 |
| | | | | | R222V | Expansion Chamber Head O-ring | \$5.31 | 8A00 23186 |
| | | | | | IR146032AFM | Intake Gasket | \$4.47 | 8000 83043 |
| | | | | | PV093032AFM | Power Valve | \$5.68 | 8000 83091 |
| | | | | | PV092018AFM | Power Valve | \$5.68 | 8000 83049 |
| | | | Bottom End Kit w/o crank seals | List Price | Component Part# | Description | List Price | OEM Part# |
| | | | C3373 | \$31.29 | WP103018AFM | Water Pump Gasket | \$1.66 | 8000 65922 |
| | | | | | EC430015F | Case Gasket | \$12.39 | 8000 72889 |
| | | | | | IR146032AM | Intake Gasket | \$4.65 | 8000 83043 |
| | | | | | WA120 | Drain Plug Washer | \$.83 | 62N0 15678 |
| | | | | | EC431032AFM | Inner Clutch Cover Gasket | \$18.99 | 8000 66968 |
| | | | | | R0071063N | Fill Plug O-ring | \$1.39 | 8000 27960 |
| | | | | | EC432031F | Mag Cover Gasket | \$7.10 | 8000 66972 |
| | | | | | R109V | Output Shaft O-ring | \$0.57 | 8000 19789 |

CR/WR 250

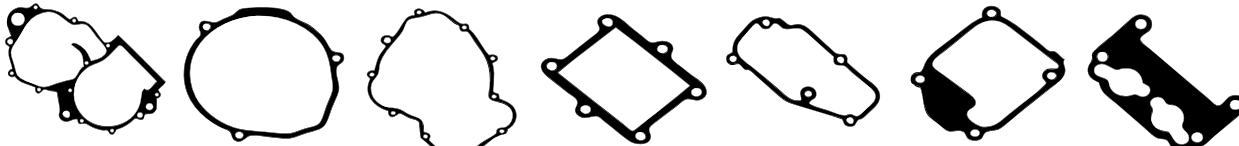

| Model | Year | Bore Size | Top End Kit | List Price | Component Part# | Component Description | List Price | OEM Part # |
|-------|-------|-----------|---------------------------------------|-------------------|------------------------|--|-------------------|------------------|
| WR250 | 99-12 | O-Ring | C7743 | \$31.14 | R041V | Inner Head O-Ring | \$5.30 | 8A00 44117 |
| CR250 | 99-12 | | | | R157B | Outer Head O-Ring | \$3.92 | 8A00 63593 |
| | | | | | B0464018AFM | Base Gasket | \$8.69 | 8A00 86902 |
| | | | | | PV095018AFM | Left Side Power Valve Cover | \$5.91 | 8000 86868 |
| | | | | | PV094018AFM | Right Side Power Valve Cover | \$2.98 | 8000 86865 |
| | | | | | IR148018AFM | Intake Gasket | \$2.13 | 8000 89954 |
| | | | | | B0464010RC | Base Gasket(0,3 mm) .011" Available Separately | \$8.69 | 8000 86902 |
| | | | | | B0464020RC | Base Gasket (0,5 mm) .019" Available Separately | \$8.69 | 8B00 86902 |
| | | | | | B0464032AFM | Base Gasket (0,8 mm) .031" Available Separately | \$8.69 | 8C00 86902 |
| | | | | | R014V | Power Valve Cover O-rings 4 Req. | \$1.08 | 8A00 23109 |
| | | | | | R017V | Front Power Valve Large O-ring | \$0.50 | 8000 36380 |
| | | | | | R021V | Front Power Valve Large O-ring | \$1.19 | 8B00 42700 |
| | | | | | R015V | Exhaust Valve Flap O-ring 2 Req. | \$1.13 | 8A00 22551 |
| | | | | | R45X3.5V | Exp. Chamber Head O-ring | \$1.64 | 8A00 31970 |
| | | | | | EX1311027C | Exp. Chamber Head Washer | \$1.69 | 8A00 73541 |
| | | | Bottom End Kit w/o crank seals | List Price | Component Part# | Description | List Price | OEM Part# |
| | | | C3374 | \$55.41 | R132B | Water Pump Gasket | \$1.69 | 8000 19965 |
| | | | | | EC451020F | Case Gasket | \$5.09 | 8000 72522 |
| | | | | | R165B | Clutch Cover O-ring | \$3.92 | 8000 86878 |
| | | | | | EC453032AFM | Inner Clutch Cover Gasket | \$18.99 | 8000 34451 |
| | | | | | EC452060AFM | Mag Cover Gasket | \$8.29 | 8000 69372 |

All Component Parts can be purchased individually.



MX/Dirt • Off-Road • ATV Gaskets



Cometic Gasket - An Exclusive NASCAR Performance® Product

TC250 TE/TXC250

| Model | Year | Bore Size | Top End Kit | List Price | Component Part# | Component Description | List Price | OEM Part # |
|-----------|-------|-----------|-------------|------------|-----------------|-----------------------------------|------------|------------|
| TC250 | 10-12 | 79mm | C3505-EST | \$80.22 | R013B | Breather Seal O-ring | \$1.19 | 8000 01199 |
| TE/TXC250 | | | | | 3239V | Valve Stem Seal 4 Req. | \$5.50 | 8000 A6356 |
| | | | | | R12X1.5V | Cam Gear Shaft O-ring 2 Req. | \$0.84 | 8000 H6884 |
| | | | | | EC1826018AFM | Cam Gear Shaft Gasket | \$3.35 | 8000 A6627 |
| | | | | | WP424018AFM | Water Pump Body Gasket | \$1.71 | 8000 H6126 |
| | | | | | WP416018AFM | Water Pump Body Gasket 2012 | \$1.71 | 8000 A7338 |
| | | | | | | TE/TXC Models | | |
| | | | | | WP423018AFM | Water Pump Cover Gasket | \$1.71 | 8000 H6125 |
| | | | | | WP417018AFM | Water Pump Cover Gasket 2012 | \$1.71 | 8000 A7346 |
| | | | | | | TE/TXC Models | | |
| | | | | | R017V | Water Outlet O-ring | \$0.50 | 8000 36380 |
| | | | | | EC1827018AFM | Intermediate Gear Shaft Gasket | \$3.35 | 8000 A6954 |
| | | | | | WA116 | Oil Line Crush Washer 2 Req. | \$3.02 | 8000 45194 |
| | | | | | H3702020S | Cylinder Head Gasket | \$45.39 | 8000 A6576 |
| | | | | | | (SP= 0,50 mm) | | |
| | | | | | H3702027S | Cylinder Head Gasket | \$45.39 | 8B00A6576 |
| | | | | | | (SP= 0,70 mm) Not included in kit | | |
| | | | | | B1134010RC | Cylinder Base Gasket | \$9.94 | 8000 A6577 |
| | | | | | | Bottom End Kit w/o crank seals | | |
| | | | | | | C3512 | \$41.95 | |
| | | | | | EC1778032AFM | Outer Clutch Cover Gasket | \$4.54 | 8000 A6999 |
| | | | | | EC1777032AFM | Inner Clutch Cover Gasket | \$19.82 | 8000 A6997 |
| | | | | | EC1780018AFM | Bevel Gear Seat Gasket | \$2.06 | 8000 A6990 |
| | | | | | EC1779 | Mag Cover Gasket | \$4.21 | 8000 A7004 |
| | | | | | WA116 | Oil Line Crush Washer 2 Req. | \$1.06 | 8000 45194 |
| | | | | | R18X2.5V | Oil Fill Plug O-ring | \$1.71 | 8000 29171 |
| | | | | | OP419032AFM | Oil Pump Gasket | \$1.91 | 8000 A7061 |
| | | | | | R013B | Oil Pipe O-ring 2 Req. | \$1.27 | 8000 01199 |
| | | | | | R017V | Kick Starter O-ring | \$0.50 | 8000 36380 |

WR360



Base

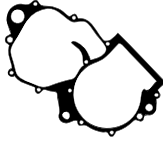

Center Case

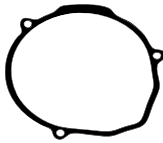

Mag Cover

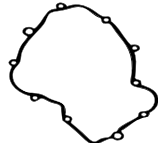

Inner Clutch

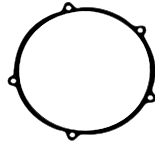

Outer Clutch



Power Valve

| Model | Year | Bore Size | Top End Kit | List Price | Component Part# | Component Description | List Price | OEM Part # |
|--------|-------|-----------|-------------|------------|-----------------|--------------------------------|------------|------------|
| WR 360 | 99-03 | O-Ring | C7745 | \$25.83 | R043V | Inner Head O-Ring | \$3.00 | 5410932 |
| CR360 | 99 | | | | R158B | Outer Head O-Ring | \$3.77 | |
| WR360 | 99 | | | | B0465018AFM | Base Gasket | \$8.36 | |
| | | | | | PV096018AFM | Power Valve Gasket | \$5.68 | 8000 73443 |
| | | | | | | Bottom End Kit w/o crank seals | | |
| | | | | | | C3375 | \$44.62 | |
| | | | | | R165B | Clutch Cover O-ring | \$3.92 | 8000 86878 |
| | | | | | EC453032AFM | Inner Clutch Gasket | \$18.29 | |
| | | | | | EC452060AFM | Mag Cover Gasket | \$7.97 | |
| | | | | | EC451020F | Center Case Gasket | \$12.39 | 8000 72522 |



MX/Dirt · Off-Road · ATV Gaskets



Cometic Gasket - An Exclusive NASCAR Performance® Product

TE410/610

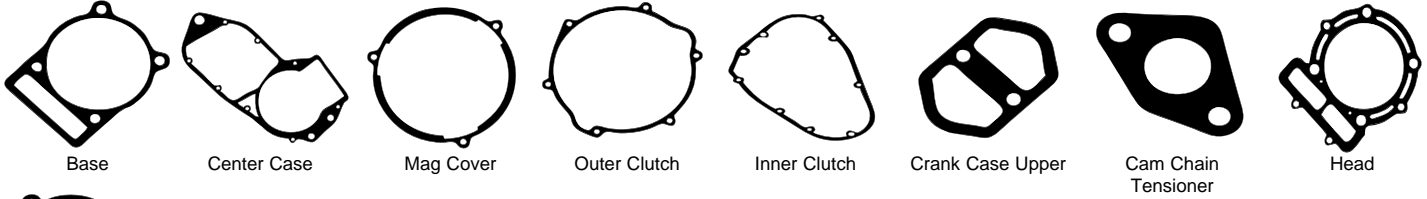

Water Pump

| Model | Year | Bore Size | Top End Kit | List Price | Component Part# | Component Description | List Price | OEM Part # |
|-----------|-------|-----------|---|-------------------|------------------------|------------------------------|-------------------|-------------------|
| TE410E | 99-01 | 95 mm | C7730 | \$36.35 | H0974059F | 95mm Head Gasket | \$20.58 | 161536001 |
| TE/TC 410 | 99-00 | | | | B0431043F | Base gasket | \$11.41 | 161540702 |
| | | | | | EC409012F | Cam Chain Tensioner Gasket | \$4.75 | 161535801 |
| | | | | | EC408015F | Upper Crankcase Gasket | \$3.80 | 161503601 |
| | | | Bottom End Kit w/o crank seals | List Price | Component Part# | Description | List Price | OEM Part# |
| | | | C3376 | \$40.57 | EC407032AFM | Left Inner Cover Gasket | \$4.75 | 161165003 |
| | | | | | EC406060AFM | Left Outer Cover Gasket | \$12.56 | 8000608191 |
| | | | | | EC405032AFM | Right Cover Gasket | \$9.11 | 161527501 |
| | | | | | EC1820020F | Center Case Gasket | \$17.84 | 161501403 |
| | | | | | WP093032AFM | Water Pump Gasket | \$7.44 | 8A00063644 |
| | | | Top End Kit | List Price | Component Part# | Component Description | List Price | OEM Part # |
| TE/TC610 | 99-01 | 99 mm | C7732 | \$77.91 | H0923059F | 99mm Head Gasket | \$27.41 | 800064726 |
| SM610R | 00-01 | | | | B0431043F | Base Gasket | \$11.41 | 161540702 |
| TE/TC610 | 99-00 | | | | EC409012F | Cam Chain Tensioner Gasket | \$4.75 | 161535801 |
| TE610E | 99-01 | | | | EC408015F | Upper Crankcase Gasket | \$3.80 | 161503601 |
| | | | Bottom End Kit w/o crank seals | List Price | Component Part# | Description | List Price | OEM Part# |
| | | | C3376 | \$42.19 | EC407032AFM | Left Inner Cover Gasket | \$4.75 | 161165003 |
| | | | | | EC406060AFM | Left Outer Cover Gasket | \$12.56 | 8000608191 |
| | | | | | EC405032AFM | Right Cover Gasket | \$9.11 | 161527501 |

KAWASAKI KDX50



Base

Exhaust

Head

Intake

| Model | Year | Bore Size | Top End Kit | List Price | Component Part# | Component Description | List Price | OEM Part # |
|-------|-------|-----------|-------------|------------|-----------------|-----------------------|------------|------------|
| KDX50 | 03-05 | 43 mm | C7014 | \$19.14 | H1281020RC | Head Gasket 43mm Bore | \$6.25 | 11004-S004 |
| | | | | | B0543020RC | Base Gasket | \$6.02 | 11061-S041 |
| | | | | | EX349042AM | Exhaust Gasket | \$3.58 | 11061-S081 |
| | | | | | IR417020F | Intake Gasket | \$1.71 | 11061-S042 |



MX/Dirt • Off-Road • ATV Gaskets



Cometic Gasket - An Exclusive NASCAR Performance® Product

KX60



| Model | Year | Bore Size | Top End Kit | List Price | Component Part# | Component Description | List Price | OEM Part # |
|-----------------------------|---------|-----------------------------------|------------------------|------------------------------|------------------------|-------------------------------|-------------------|-------------------|
| KX60 | 85-98 | 45 mm | C7154 | \$22.99 | H0262043F | Head Gasket 45mm | \$17.38 | 11004-1218 |
| | | 48 mm | C7605 | \$22.99 | H0520043F | Head Gasket 48mm | \$17.38 | 11004-1218 |
| | | 53 mm | C7606 | \$22.99 | H0692043F | Head Gasket 53mm | \$17.38 | 11004-1218 |
| | | | | | B0162018AFM | Base Gasket | \$6.25 | 11009-1975 |
| | | | | | B0162012F | High Compression Base Gasket | \$6.25 | |
| KX60 | 99-03 | 45 mm | C7501 | \$22.99 | H0262043F | Head Gasket 45mm | \$17.38 | 11004-1218 |
| | | | | | B0371018AFM | Base Gasket | \$6.19 | 11060-1873 |
| | | | | | B0371012F | High Compression Base Gasket | \$6.19 | 11060-1873 |
| KX60 | 85-03 | Bottom End Kit w/Oil Seals | | List Price | Component Part# | Component Description | List Price | OEM Part # |
| | | | C7154BE | \$49.00 | R9X2V | Clutch Pushrod O-ring | \$1.59 | 670B1509 |
| | | | | | WA107 | Drain Plug Seal | \$2.74 | 92065-058 |
| | | | | | WP0500032AFM | Water Elbow Outlet | \$2.44 | 11009-1952 |
| | | | | | R222V | Water Pump Body O-ring | \$3.92 | 670B3039 |
| | | | | | WA107 | Trans Fluid Drain Plug | \$2.74 | 92065-058 |
| | | | | | R013B | Output Shaft O-ring | \$1.19 | 92055-022 |
| | | Oil Seal Kit | | List Price | Component Part# | Component Description | List Price | OEM Part # |
| | | | C7736OS | \$43.94 | OS331 | Shift Shaft Seal 13x22x5.5 | \$3.71 | 92051-005 |
| | | | | | OS131 | Output Shaft Seal 25x37x6 | \$7.10 | 92050-013 |
| | | | | | OS110 | Crank Seal 20x40x7 | \$9.47 | 92049-1188 |
| | | | | | OS366 | Start Shaft Seal 16x24x4 | \$4.25 | 92049-002 |
| | | | | | OS368 | Water Pump Shaft Seal 8x18x10 | \$8.75 | 92049-1366 |
| Clutch & Mag Kit | | List Price | Component Part# | Component Description | List Price | OEM Part # | | |
| | C7736CM | \$17.38 | EC275032AFM | Clutch Cover Gasket | \$8.69 | 11009-1976 | | |
| | | | EC2740032AFM | Mag Cover Gasket | \$8.69 | 11009-1974 | | |

KX65

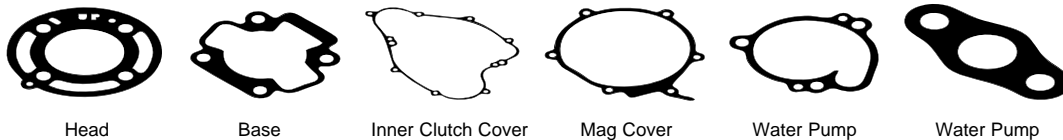

| Model | Year | Bore Size | Top End Kit | List Price | Component Part# | Component Description | List Price | OEM Part # |
|-------|-------|-----------|-------------------------------------|-------------------|------------------------|------------------------------|-------------------|-------------------|
| KX65 | 00-16 | 45 mm | C7736 | \$22.99 | H0970010S | Head Gasket 45mm | \$18.56 | 11004-1346 |
| | | 47 mm | C7682 | \$22.99 | H0971010S | Head Gasket 47mm | \$18.56 | 11004-1346 |
| | | 48 mm | C7737 | \$22.99 | H0972010S | Head Gasket 48mm | \$18.56 | 11004-1346 |
| | | | | | B0444018AFM | Base Gasket | \$6.19 | 11060-1921 |
| | | | | | B0444012F | High Compression Base Gasket | \$6.19 | 11060-1921 |
| | | | | | R218V | Exhaust O-Ring 2 Req | \$1.19 | 670E3032 |
| | | | Bottom End Kit w/crank seals | List Price | Component Part# | Component Description | List Price | OEM Part # |
| | | | C3344 | \$34.92 | C3048 | Clutch Cover Gasket | \$9.32 | 11060-1925 |
| | | | | | EC274018AFM | Mag Cover Gasket | \$8.69 | 11009-1974 |
| | | | | | WP105018AFM | Water Pipe Gasket | \$2.16 | 11060-1927 |
| | | | | | WP104018AFM | Water Pump Gasket | \$2.16 | 11060-1924 |
| | | | Clutch & Mag Kit | List Price | Component Part# | Component Description | List Price | OEM Part # |
| | | | C7736CM | \$18.01 | 3048 | Clutch Cover Gasket | \$9.32 | 11060-1925 |
| | | | | | EC274018AFM | Mag Cover Gasket | \$8.69 | 11009-1974 |
| | | | Crank Seal Kit | List Price | Component Part# | Component Description | List Price | OEM Part # |
| | | | C7656 | \$16.99 | OS110 | 20X40X7 Oil Seal 2 Req | \$9.47 | 92049-1188 |
| | | | | | EC274018AFM | Mag Cover Gasket | \$8.69 | 11009-1974 |



MX/Dirt • Off-Road • ATV Gaskets



Cometic Gasket - An Exclusive NASCAR Performance® Product

KX80/100

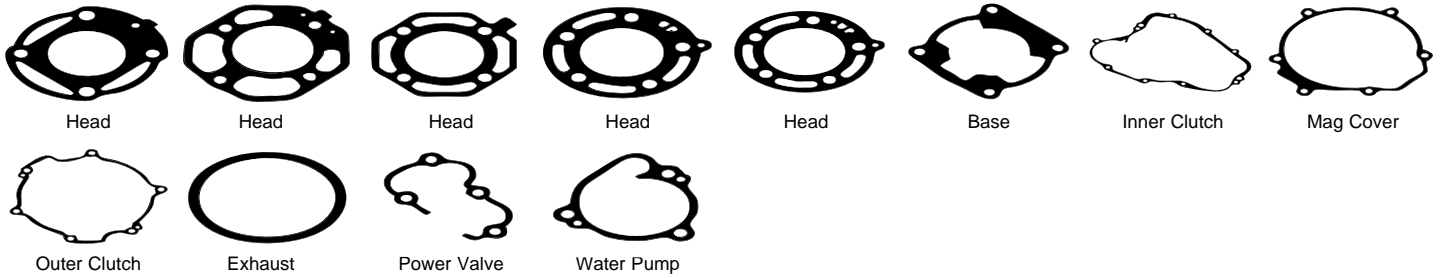

| Model | Year | Bore Size | Top End Kit | List Price | Component Part# | Component Description | List Price | OEM Part # |
|-----------------|-------|-----------|-------------------------------------|-------------------|------------------------|------------------------------|-------------------|-------------------|
| KX80 EZ | 83-84 | 50 mm | C7027 | \$22.99 | H0025043F | Head Gasket 50mm | \$22.32 | 11004-1058 |
| | | | C7028 | \$22.99 | B0028020F | Base Gasket | \$4.65 | 11009-1975 |
| | | | Crank Seal Kit | List Price | Component Part# | Component Description | List Price | OEM Part # |
| | | | C7656 | \$16.99 | OS110 | 20X40X7 Oil Seal 2 Req | \$9.47 | 92049-1188 |
| KX80 G1, G2 | 86-87 | 50 mm | C7029 | \$22.99 | H0026043F | Head Gasket 50mm | \$14.87 | 11004-1138 |
| | | 53 mm | C7318 | \$22.99 | H0447043F | Head Gasket 53mm | \$21.76 | |
| | | | Crank Seal Kit | List Price | Component Part# | Component Description | List Price | OEM Part # |
| | | | C7656 | \$16.99 | OS110 | 20X40X7 Oil Seal 2 Req | \$9.47 | 92049-1188 |
| KX80 L1, L2, L3 | 88-90 | 50 mm | C7030 | \$22.99 | H0027043F | Head Gasket 50mm | \$14.87 | 11004-1168 |
| | | 53 mm | C7319 | \$22.99 | H0448043F | Head Gasket 53mm | \$14.87 | |
| | | | Crank Seal Kit | List Price | Component Part# | Component Description | List Price | OEM Part # |
| | | | C7656 | \$16.99 | OS110 | 20X40X7 Oil Seal 2 Req | \$9.47 | 92049-1188 |
| KX80 | 91-97 | 49 mm | C7031 | \$22.99 | H0271010S | Head Gasket 49mm | \$14.87 | 11004-1213 |
| | | 50 mm | C7307 | \$22.99 | H0441010S | Head Gasket 50mm | \$14.87 | |
| | | | Bottom End Kit w/crank seals | List Price | Component Part# | Component Description | List Price | OEM Part # |
| | | | C3345 | \$31.99 | EC191018AFM | Mag Cover Gasket | \$8.69 | 11009-1973 |
| | | | | | C7493 | Inner Clutch Cover Gasket | \$8.69 | 11009-1971 |
| | | | | | WP036018AFM | Water Pump Gasket | \$3.74 | 11009-1972 |
| | | | Crank Seal Kit | List Price | Component Part# | Component Description | List Price | OEM Part # |
| | | | C7656 | \$16.99 | OS110 20X40X7 | 20X40X7 Oil Seal 2 Req | \$9.47 | 92049-1188 |
| KX80 | 98-00 | 49 mm | C7391 | \$22.91 | H0271010S | Head Gasket | \$14.87 | 11004-1213 |
| | | | | | B0311018AFM | Base Gasket | \$4.65 | 11060-1779 |
| | | | Bottom End Kit w/crank seals | List Price | Component Part# | Component Description | List Price | OEM Part # |
| | | | C3345 | \$31.99 | EC191018AFM | Mag Cover Gasket | \$8.69 | 11009-1973 |
| | | | | | C7493 | Inner Clutch Cover Gasket | \$8.91 | 11009-1971 |
| | | | | | WP036018AFM | Water Pump Cover Gasket | \$3.74 | 11009-1972 |
| | | | Crank Seal Kit | List Price | Component Part# | Component Description | List Price | OEM Part # |
| | | | C7656 | \$16.99 | OS110 | 20X40X7 Oil Seal 2 Req | \$9.47 | 92049-1188 |



MX/Dirt • Off-Road • ATV Gaskets



Cometic Gasket - An Exclusive NASCAR Performance® Product

KAWASAKI

| Model | Year | Bore Size | Top End Kit | List Price | Component Part# | Component Description | List Price | OEM Part # | | |
|-------|-------|-----------|-------------------------------------|-------------------|---------------------------------------|--------------------------------|------------------------------|--------------------------------|-------------------|-------------------|
| KX85 | 01-13 | 48.5 mm | C3501 | \$25.55 | H11020SP1010S | Head Gasket 48.5mm | \$14.87 | 11004-1360 | | |
| | | | C7859 | | B0311018AFM | Base Gasket | \$4.65 | 11060-1779 | | |
| | | 50.5 mm | | | | B0311012F | High Compression Base Gasket | \$6.25 | 11060-1779 | |
| | | | | | | EX297063C | Exhaust Gasket | \$4.37 | 11060-1842 | |
| | | | | | | PV066018AFM | KIPS Cover Gasket | \$3.80 | 11060-1778 | |
| | | | | | | R126V | Exhaust O-Ring 2 Req | \$1.19 | 671E2535 | |
| | | | | | | | | | | |
| | | | | | Bottom End Kit w/crank seals | List Price | Component Part# | Component Description | List Price | OEM Part # |
| | | | | | C3346 | \$32.99 | EC191018AFM | Mag Cover Gasket | \$8.69 | 11009-1973 |
| | | | | | | | EC513018AFM | Outer Clutch Cover | \$9.94 | 11060-1795 |
| | | | | | | | C7493 | Inner Clutch Cover Gasket | \$8.91 | 11009-1971 |
| | | | | | | | WP036018AFM | Water Pump Gasket | \$3.74 | 11009-1972 |
| | | | | | Clutch & Mag Kit | List Price | Component Part# | Component Description | List Price | OEM Part # |
| | | | | | C3501CM | \$18.63 | EC513018AFM | Outer Clutch Cover | \$9.94 | 11060-1795 |
| | | | | | EC191018AFM | Mag Cover Gasket | \$8.69 | 11009-1973 | | |
| | | | Crank Seal Kit | List Price | Component Part# | Component Description | List Price | OEM Part # | | |
| | | | C7656 | \$16.99 | OS110 | 20X40X7 Oil Seal 2 Req | \$9.47 | 92049-1188 | | |
| KX85 | 14-16 | 48.5 mm | C3541 | 25.55 | H3880012S | Head Gasket 48.5mm Bore | 14.87 | 11004-0737 | | |
| | | | | | B0311018AFM | Base Gasket | 4.65 | 11060-1779 | | |
| | | | | | | B0311012F | High Compression Base Gasket | 6.25 | 11060-1779 | |
| | | | | | | EX297063C | Exhaust Gasket | 4.37 | 11060-1842 | |
| | | | | | | PV145018AFM | Front Power Valve Gasket | 4.72 | 11061-0889 | |
| | | | | | | PV066018AFM | KIPS Cover Gasket | 3.80 | 11060-1778 | |
| | | | | | | R219V | Exhaust O-Ring 2 Req | 3.92 | 670E3034 | |
| | | | | | | | | | | |
| | | | | | Top End Kit | List Price | Component Part# | Component Description | List Price | OEM Part # |
| | | | | | C7268 | \$35.72 | H0342010S | Head Gasket 53mm | \$20.99 | 11004-1214 |
| | | | | | C7347 | \$35.72 | H0490010S | Head Gasket 54.5mm | \$20.99 | |
| | | | | | | | B0029018AFM | Base Gasket | \$7.16 | 11009-1970 |
| | | | | | | | R221V | Exhaust O-Ring 2 Req | \$3.92 | 670E3036 |
| | | | | | | | | | | |
| | | | Bottom End Kit w/crank seals | List Price | Component Part# | Component Description | List Price | OEM Part # | | |
| | | | C3347 | \$31.99 | EC191018AFM | Mag Cover Gasket | \$8.69 | 11009-1973 | | |
| | | | | | C7493 | Inner Clutch Cover Gasket | \$8.91 | 11009-1971 | | |
| | | | | | WP036018AFM | Water Pump Gasket | \$3.74 | 11009-1972 | | |
| | | | Crank Seal Kit | List Price | Component Part# | Component Description | List Price | OEM Part # | | |
| | | | C7656 | \$16.99 | OS110 20X40X7 | 20X40X7 Oil Seal 2 Req | \$9.47 | 92049-1188 | | |
| KX100 | 95-97 | 53 mm | C7392 | \$35.72 | H0342010S | Head Gasket 53mm | \$20.99 | 11004-1214 | | |
| | | | C7413 | \$35.72 | H0490010S | Head Gasket 54.5mm | \$20.99 | | | |
| | | 54.5 mm | | | | B0311018AFM | Base Gasket | \$4.65 | 11060-1779 | |
| | | | | | | | B0311012F | High Compression Base Gasket | \$6.25 | 11060-1779 |
| | | | | | | EX297063C | Exhaust Gasket | \$4.37 | 11060-1842 | |
| | | | | | | PV066018AFM | KIPS Cover Gasket | \$3.80 | 11060-1778 | |
| | | | | | | WA128 | Head Bolt Washer 5 Req | \$1.59 | 92022-304 | |
| | | | | | | R126V | Exhaust O-Ring 2 Req | \$1.19 | 670E3036 | |
| | | | | | | | | | | |
| | | | | | Bottom End Kit w/o crank seals | List Price | Component Part# | Component Description | List Price | OEM Part # |
| | | | | | C3347 | \$31.99 | EC191018AFM | Mag Cover Gasket | \$8.69 | 11009-1973 |
| | | | | | | | EC513018AFM | Outer Clutch Cover Gasket | \$9.94 | 11060-1795 |
| | | | | | | | C7493 | Inner Clutch Cover Gasket | \$8.91 | 11009-1971 |
| | | | | | | | WP036018AFM | Water Pump | \$3.74 | 11009-1972 |
| | | | Clutch & Mag Kit | List Price | Component Part# | Component Description | List Price | OEM Part # | | |
| | | | C3501CM | \$18.01 | EC513018AFM | Outer Clutch Cover Gasket | \$9.94 | 11060-1795 | | |
| | | | | | EC191018AFM | Mag Cover Gasket | \$8.69 | 11009-1973 | | |
| | | | Crank Seal Kit | List Price | Component Part# | Component Description | List Price | OEM Part # | | |
| | | | C7656 | \$16.99 | OS110 20X40X7 | 20X40X7 Oil Seal 2 Req | \$9.47 | 92049-1188 | | |
| KX100 | 14-16 | 52.5 mm | C3542 | \$25.55 | H3881012S | Cylinder Head Gasket | \$14.87 | 11004-0739 | | |
| | | | C3543 | \$25.55 | H3881SP1012S | Cyl. Head Gasket 112cc MOD | \$14.87 | | | |
| | | 54.5 mm | | | | PV145018AFM | Power Valve Cover Gasket | \$4.72 | 11061-0889 | |
| | | | | | | | PV066018AFM | Right Power Valve Cover Gasket | \$3.80 | 11060-1778 |
| | | | | | | B0311018AFM | Base Gasket | \$4.65 | 11060-1779 | |
| | | | | | | WA128 | Cyl. Head Water Jacket Seal | \$1.59 | 92022-304 | |
| | | | | | | | 6.2X11X1 | | | |
| | | | | | | | R219V | Exhaust Gasket | \$3.92 | 670E3034 |
| | | | | | | | | | | |
| | | | | | Top End Kit | List Price | Component Part# | Component Description | List Price | OEM Part # |
| | | | C3542 | \$25.55 | H3881012S | Cylinder Head Gasket | \$14.87 | 11004-0739 | | |
| | | | C3543 | \$25.55 | H3881SP1012S | Cyl. Head Gasket 112cc MOD | \$14.87 | | | |
| | | | | | PV145018AFM | Power Valve Cover Gasket | \$4.72 | 11061-0889 | | |
| | | | | | PV066018AFM | Right Power Valve Cover Gasket | \$3.80 | 11060-1778 | | |
| | | | | | B0311018AFM | Base Gasket | \$4.65 | 11060-1779 | | |
| | | | | | WA128 | Cyl. Head Water Jacket Seal | \$1.59 | 92022-304 | | |
| | | | | | | 6.2X11X1 | | | | |
| | | | | | R219V | Exhaust Gasket | \$3.92 | 670E3034 | | |



MX/Dirt · Off-Road · ATV Gaskets



Cometic Gasket - An Exclusive NASCAR Performance® Product

KLX110

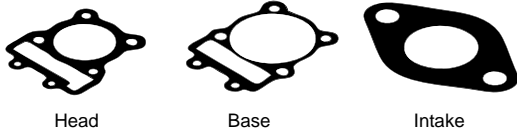

| Model | Year | Bore Size | EST Top End Kit | List Price | Component Part# | Component Description | List Price | OEM Part # |
|--------|-------|-----------|--------------------|------------|------------------------|---------------------------------|-------------------|-------------------|
| KLX110 | 03-16 | 55 mm | C7939-EST | \$41.68 | H1891010S | Head Gasket 55mm | \$18.56 | 11004-1338 |
| | | 57 mm | C7949-EST | \$41.68 | H1917010S | Head Gasket 57mm | \$18.56 | 11004-1338 |
| | | | | | B0678SP2020RC | Base Gasket | \$9.94 | 11060-1796 |
| | | | | | IR431018AFM | Intake Gasket | \$2.33 | K1106-01753 |
| | | | | | R022B | Intake O-rings 2 Req. | \$1.13 | K9205-51527 |
| | | | | | EX781 | Exhaust Gasket | \$3.35 | K1106-11112 |
| | | | | | R110B | Cam Chain Tensioner Bolt O-ring | \$1.13 | KK670-D2010 |
| | | | | | R117B | Cam Chain Tensioner O-ring | \$0.42 | KK670-D2021 |
| | | | | | 3183V | Valve Seals | \$5.50 | K9204-91349 |
| | | | | | R91X2.5V | Cam Cover O-ring | \$7.36 | K9205-51527 |
| | | | | | R031B | Tappet Cover O-rings 2 Req. | \$4.65 | K9205-51231 |
| | | | | | Component Part# | Component Description | List Price | OEM Part # |
| | | | | | EC1102018AFM | Clutch Cover Gasket | \$5.91 | 11061-0131 |

KLX125



| Model | Year | Bore Size | Top End Kit | List Price | Component Part# | Component Description | List Price | OEM Part # |
|--------|-------|-----------|-------------|------------|-----------------|-------------------------------|------------|------------|
| KLX125 | 03-06 | 59 mm | C7835 | \$29.11 | H1892027S | Head Gasket 59mm | \$18.56 | 11004-S003 |
| | | 61 mm | C3109 | \$29.11 | H1926027S | Head Gasket 57mm | \$18.56 | 11004-S003 |
| | | | | | B0679020F | Base Gasket | \$6.25 | 11061-S035 |
| | | | | | EC824032AFM | Timing Chain Tensioner Gasket | \$3.07 | 11061-S038 |
| | | | | | R216B | Valve Cap Cover O-Ring 2 Req | \$3.74 | 92055-S036 |
| | | | | | R010B | Cam Chain Bolt O-ring | \$0.62 | 95055-S032 |

KAWASAKI KX125

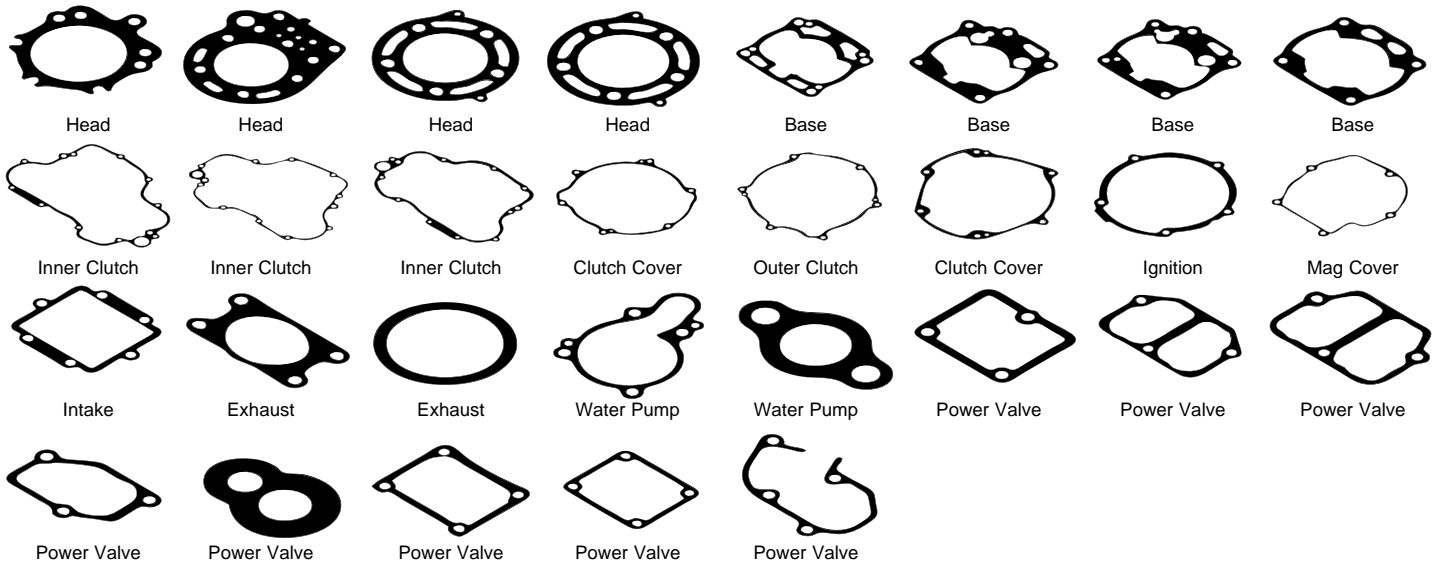



MX/Dirt • Off-Road • ATV Gaskets



Cometic Gasket - An Exclusive NASCAR Performance® Product

KAWASAKI

| Model | Year | Bore Size | Top End Kit | List Price | Component Part# | Component Description | List Price | OEM Part # |
|---------------------|-------|-----------|-------------|------------|-------------------------|--------------------------|----------------------------------|---|
| KX125 | 78-79 | 57 mm | C7130 | \$22.83 | H0165020C | Head Gasket 57mm | \$19.99 | 11004-1006 |
| | | | | | B0108020F | Base Gasket | \$5.34 | 11009-1042 |
| KX125 | 80-81 | 57 mm | C7131 | \$20.44 | H0164043F | Head Gasket 57mm | \$17.38 | 11004-1023 |
| | | | | | B0108020F | Base Gasket | \$5.34 | 11009-1175 |
| KX125 | 82-83 | 58 mm | C7109 | \$20.44 | H0029043F | Head Gasket 58mm | \$17.38 | 11004-1048 |
| | | | | | B0024020F | Base Gasket | \$5.34 | 11009-1258 |
| KX125 | 84 | 58 mm | C7110 | \$20.44 | H0248043F | Head Gasket 58mm | \$17.38 | 11004-1112 |
| | | | | | B0024020F | Base Gasket | \$5.34 | 11009-1258 |
| KX125 D1, E1, E2 | 85-86 | 58 mm | C7032 | \$32.82 | H0021043F | Head Gasket 58mm | \$17.38 | 11004-1160 |
| | | | | | B0024020F | Base Gasket | \$5.34 | 11009-1258 |
| | | | | | I R007018AFM | Intake Gasket | \$3.80 | 11009-1941 |
| | | | | | PV053020F | Left Side Power Valve | \$3.80 | 11009-1478 |
| | | | | | PV054060AFM | Right Side Power Valve | \$3.80 | 11009-1479 |
| | | | | | R224V | Exhaust O-Ring 2 Req | \$1.19 | 670E3045 |
| | | | | | Crank Seal Kit C7698 | List Price \$25.65 | Component Part# OS110 20X40X7 | Component Description 20X40X7 Oil Seal 2 Req |
| KX125 | 87 | 58 mm | C7119 | \$35.72 | R223V | Exhaust O-Ring 2 Req | \$3.92 | 670E3039 |
| | | | | | PV054060AFM | Right Power Valve Gasket | \$3.80 | 11009-1479 |
| | | | | | PV052020F | Left Power Valve Gasket | \$3.80 | 11009-1641 |
| | | | | | IR007018AFM | Intake Gasket | \$3.80 | 11009-1941 |
| | | | | | H0021043F | Head Gasket 58mm | \$17.38 | 11004-1160 |
| | | | | | B0024020F | Base Gasket | \$5.34 | 11009-1258 |
| | | | | | Crank Seal Kit C7657 | List Price \$16.99 | Component Part# OS112 | Component Description Right Oil Seal |
| KX125 F1 | 88 | 58 mm | C7033 | \$35.72 | H0030043F | Head Gasket 58mm | \$17.38 | 11004-1188 |
| | | | | | B0030020F | Base Gasket | \$5.34 | 11009-1940 |
| | | | | | IR007018AFM | Intake Gasket | \$3.80 | 11009-1941 |
| | | | | | PV009018AFM | Left Power Valve Gasket | \$3.80 | 11009-1938 |
| | | | | | PV010020F | Right Power Valve Gasket | \$3.80 | 11009-1934 |
| | | | | | R223V | Exhaust O-Ring 2 Req | \$3.92 | 670E3039 |
| | | | | | Crank Seal Kit C7657 | List Price \$16.99 | Component Part# OS111 | Component Description Left Oil Seal |
| KX125 G1 | 89 | 58 mm | C7034 | \$35.72 | H0031043F | Head Gasket | \$17.38 | 11004-1188 |
| | | | | | B0030020F | Base Gasket | \$5.34 | 11009-1690 |
| | | | | | IR007018AFM | Intake Gasket | \$3.80 | 11009-1263 |
| | | | | | PV009018AFM | Front Power Valve Gasket | \$3.80 | 11009-1691 |
| | | | | | PV010020F | Left Side Power Valve | \$3.80 | 11009-1692 |
| | | | | | R223V | Exhaust O-Ring 2 Req | \$3.92 | 670E3039 |
| | | | | | Crank Seal Kit C7657 | List Price \$16.99 | Component Part# OS112 | Component Description Right Oil Seal |
| KX125 H, H1 | 90-91 | 58 mm | C7035 | \$35.72 | H0032010S | Head Gasket 58mm | \$17.38 | 11004-1204 |
| | | | | | B0030020F | Base Gasket | \$5.34 | 11009-1824 |
| | | | | | IR007018AFM | Intake Gasket | \$3.80 | 11009-1941 |
| | | | | | PV010020F | Left Side Power Valve | \$3.80 | 11009-1692 |
| | | | | | PV009018AFM | Front Power Valve Gasket | \$3.80 | 11009-1691 |
| | | | | | R223V | Exhaust O-Ring 2 Req | \$3.92 | 670E3039 |
| | | | | | Crank Seal Kit C7657 | List Price \$16.99 | Component Part# OS111 | Component Description Left Oil Seal |



MX/Dirt · Off-Road · ATV Gaskets



Cometic Gasket - An Exclusive NASCAR Performance® Product

KAWASAKI

| Model | Year | Bore Size | Top End Kit | List Price | Component Part# | Component Description | List Price | OEM Part # | | | | | |
|-------------------------------------|------------------------|------------------------|------------------------------|-------------------|-------------------------------------|-------------------------------|------------------------|------------------------------|-------------------|-------------------|------------------------------|---------|------------|
| KX125 | 92 | 56 mm | C7117 | \$35.72 | H0251010S | Head Gasket 56mm | \$17.38 | 11004-1231 | | | | | |
| | | | | | B0031020F | Base Gasket | \$5.34 | 11060-1188 | | | | | |
| | | | | | IR007018AFM | Intake Gasket | \$3.80 | 11009-1941 | | | | | |
| | | | | | PV009018AFM | Front Power Valve Gasket | \$3.80 | 11009-1934 | | | | | |
| | | | | | PV011020F | Right Side Power Valve Gasket | \$3.80 | 11060-1187 | | | | | |
| | | | | | R223V | Exhaust O-Ring 2 Req | \$3.92 | 670E3039 | | | | | |
| | | | | | Clutch & Mag Kit | List Price | Component Part# | Component Description | List Price | OEM Part # | | | |
| | | | | | C7117CM | \$16.13 | EC198018AFM | Outer Clutch Cover Gasket | \$8.69 | 11060-1351 | | | |
| | | | | | | | EC199018AFM | Mag Cover Gasket | \$7.44 | 11060-1189 | | | |
| | | | | | Crank Seal Kit | List Price | Component Part# | Component Description | List Price | OEM Part # | | | |
| | | | | | C7657 | \$16.99 | OS112 | Right Oil Seal | \$10.68 | 92049-1301 | | | |
| | | | | | | | OS111 | Left Oil Seal | \$8.29 | 92049-1300 | | | |
| KX125 | 93-94 | 56 mm | C7133 | \$35.72 | H0251010S | Head Gasket 56mm | \$17.38 | 11004-1252 | | | | | |
| | | | | | B0031020F | Base Gasket | \$5.34 | 11060-1188 | | | | | |
| | | | | | IR007018AFM | Intake Gasket | \$3.80 | 11009-1941 | | | | | |
| | | | | | PV067018AFM | Power Valve Rod Gasket | \$3.80 | 11060-1346 | | | | | |
| | | | | | PV043018AFM | Front Power Valve Gasket | \$3.80 | 11060-1194 | | | | | |
| | | | | | PV011020F | Right Power Valve Gasket | \$3.80 | 11060-1187 | | | | | |
| | | | | | WP030018AFM | Water Inlet Gasket | \$1.93 | 11009-1935 | | | | | |
| | | | | | R223V | Exhaust O-Ring 2 Req | \$3.92 | 670E3039 | | | | | |
| | | | | | Bottom End Kit w/crank seals | List Price | Component Part# | Component Description | List Price | OEM Part # | | | |
| | | | | | C3349 | \$43.97 | EC199018AFM | Mag Cover Gasket | \$7.44 | 11060-1189 | | | |
| | | | | | | | EC198018AFM | Outer Clutch Cover Gasket | \$8.69 | 11060-1351 | | | |
| | | | | | | | EC197018AFM | Inner Clutch Cover Gasket | \$16.13 | 11060-1350 | | | |
| | | | | | | | WP037018AFM | Water Pump Gasket | \$3.74 | 11009-1936 | | | |
| | | | | | Clutch & Mag Kit | List Price | Component Part# | Component Description | List Price | OEM Part # | | | |
| | | | | | C7117CM | \$16.13 | EC198018AFM | Outer Clutch Cover Gasket | \$8.69 | 11060-1351 | | | |
| | | | | | | | EC199018AFM | Mag Cover Gasket | \$7.44 | 11060-1189 | | | |
| | | | | | Crank Seal Kit | List Price | Component Part# | Component Description | List Price | OEM Part # | | | |
| | | | | | C7657 | \$16.99 | OS112 | Right Side Oil Seal | \$10.68 | 92049-1301 | | | |
| | | | | | | | OS111 | Left Oil Seal | \$8.29 | 92049-1300 | | | |
| | | | | | KX125 | 95-97 | 56 mm | C7241 | \$35.72 | H0251010S | Head Gasket 56mm | \$17.38 | 11004-1252 |
| | | | | | | | | | | H0410010S | Head Gasket 58mm | \$17.38 | |
| | | | | | | | | | | B0181018AFM | Base Gasket | \$5.34 | 11060-1647 |
| | | | | | | | | | | B0181012F | High Compression Base Gasket | \$5.34 | |
| | | | | | | | | | | IR007018AFM | Intake Gasket | \$3.80 | 11009-1941 |
| R223V | Exhaust O-Ring 2 Req | \$3.92 | 670E3039 | | | | | | | | | | |
| PV043018AFM | Front Power Valve | \$3.80 | 11060-1690 | | | | | | | | | | |
| PV044060AFM | Right Power Valve | \$3.80 | 11060-1686 | | | | | | | | | | |
| PV067018AFM | Power Valve Rod Gasket | \$3.80 | 11060-1346 | | | | | | | | | | |
| Bottom End Kit w/crank seals | List Price | Component Part# | Component Description | List Price | | | | | | OEM Part # | | | |
| C3349 | \$43.97 | WP030018AFM | Water Inlet Gasket | \$1.93 | | | | | | 11009-1935 | | | |
| | | EC197018AFM | Inner Clutch Cover Gasket | \$16.13 | | | | | | 11060-1350 | | | |
| | | EC198018AFM | Outer Clutch Cover Gasket | \$8.69 | | | 11060-1351 | | | | | | |
| | | EC199018AFM | Mag Cover Gasket | \$7.44 | | | 11060-1189 | | | | | | |
| | | WP037018AFM | Water Pump Gasket | \$3.74 | | | 11009-1936 | | | | | | |
| Clutch & Mag Kit | List Price | Component Part# | Component Description | List Price | | | OEM Part # | | | | | | |
| C7117CM | \$16.13 | EC198018AFM | Outer Clutch Cover Gasket | \$8.69 | | | 11060-1351 | | | | | | |
| | | EC199018AFM | Mag Cover Gasket | \$7.44 | | | 11060-1189 | | | | | | |
| Crank Seal Kit | List Price | Component Part# | Component Description | List Price | | | OEM Part # | | | | | | |
| C7657 | \$16.99 | OS112 | Right Side Oil Seal | \$10.68 | | | 92049-1301 | | | | | | |
| | | OS111 | Left Side Oil Seal | \$8.29 | | | 92049-1300 | | | | | | |



MX/Dirt • Off-Road • ATV Gaskets



Cometic Gasket - An Exclusive NASCAR Performance® Product

KAWASAKI

| Model | Year | Bore Size | Top End Kit | List Price | Component Part# | Component Description | List Price | OEM Part # | | |
|-------|-------|-----------|-----------------------------|-------------------|-----------------------------|------------------------------|-------------------------------|------------------------------|-------------------|-------------------|
| KX125 | 98-00 | 56 mm | C7393 | \$35.72 | H0251010S | Head Gasket 56mm | \$17.38 | 11004-1252 | | |
| | | | 58 mm | C7414 | \$35.72 | H0410010S | Head Gasket 58mm | \$17.38 | | |
| | | | | | | | B0423018AFM | Base Gasket - 2000 | \$5.34 | 11060-1955 |
| | | | | | | B0181018AFM | Base Gasket | \$5.34 | 11060-1769 | |
| | | | | | | B0423012F | High Comp. Base Gasket - 2000 | \$5.34 | | |
| | | | | | | B0181012F | Big Bore High Comp. Base | \$5.34 | | |
| | | | | | | IR007018AFM | Intake Gasket | \$3.80 | 11009-1941 | |
| | | | | | | EX292080C | Exhaust Gasket | \$8.63 | 11060-1370 | |
| | | | | | | EX123020C | Exhaust Manifold Gasket | \$8.57 | 11060-1790 (1) | |
| | | | | | | PV108032AFM | Front Power Valve Gasket | \$3.80 | 11060-1788 | |
| | | | | | | PV067018AFM | Power Valve Rod Gasket | \$3.80 | 11060-1346 | |
| | | | | | | PV065018AFM | Right Power Valve Cover | \$3.80 | 11060-1789 | |
| | | | | | | WP030018AFM | Water Inlet Gasket | \$1.93 | 11009-1935 | |
| | | | | | | R223V | Exhaust O-Ring 2 Req | \$3.92 | 670E3039 | |
| | | | | | Bottom End Kit | List Price | Component Part# | Component Description | List Price | OEM Part # |
| | | | | | w/crank seals | | | | | |
| | | | | | C3349 | \$43.97 | EC199018AFM | Mag Cover Gasket | \$7.44 | 11060-1189 |
| | | | | | | | EC198018AFM | Outer Clutch Cover Gasket | \$8.69 | 11060-1351 |
| | | | | | | | EC197018AFM | Inner Clutch Cover Gasket | \$16.13 | 11060-1350 |
| | | | | | | | WP037018AFM | Water Pump Cover Gasket | \$3.74 | 11009-1936 |
| | | | | | WP030018AFM | Water Inlet Pipe | \$1.93 | 11009-1935 | | |
| | | | Clutch & Mag Kit | List Price | Component Part# | Component Description | List Price | OEM Part # | | |
| | | | C7117CM | \$16.13 | EC198018AFM | Outer Clutch Cover Gasket | \$8.69 | 11060-1351 | | |
| | | | | | EC199018AFM | Mag Cover Gasket | \$7.44 | 11060-1189 | | |
| | | | Crank Seal Kit | List Price | Component Part# | Component Description | List Price | OEM Part # | | |
| | | | C7657 | \$16.99 | OS112 | Right Side Oil Seal | \$10.68 | 92049-1301 | | |
| | | | | | OS111 | Left Side Oil Seal | \$8.29 | 92049-1300 | | |
| KX125 | 01-02 | 56 mm | Top End Kit | List Price | Component Part# | Component Description | List Price | OEM Part # | | |
| | | | C7762 | \$38.33 | H0251010S | Head Gasket 56mm | \$17.38 | 11004-1252 | | |
| | | 58 mm | C7763 | \$38.33 | H0410010S | Head Gasket 58mm | \$17.38 | | | |
| | | | | | | | B0502018AFM | Base Gasket | \$9.03 | 11060-1998 |
| | | | | | | B0502012F | High Compression Base Gasket | \$9.03 | | |
| | | | | | | EX292080C | Exhaust Gasket | \$8.63 | 11060-1370 | |
| | | | | | | EX123020C | Exhaust Manifold Gasket | \$8.57 | 11060-1790 | |
| | | | | | | IR007018AFM | Intake Gasket | \$3.80 | 11009-1941 | |
| | | | | | | PV065018AFM | Right Power Valve Cover | \$3.80 | 11060-1789 | |
| | | | | | | PV067018AFM | Power Valve Rod Gasket | \$3.80 | 11060-1346 | |
| | | | | | | PV108032AFM | Front Power Valve Gasket | \$3.80 | 11060-1876 | |
| | | | | | | WP030018AFM | Water Inlet Pipe | \$1.93 | 11009-1935 | |
| | | | | | | R223V | Exhaust O-Ring 2 Req | \$3.92 | 670E3042 | |
| | | | | | Bottom End Kit | List Price | Component Part# | Component Description | List Price | OEM Part # |
| | | | | | w/crank seals | | | | | |
| | | | | | C3349 | \$43.97 | EC199060AFM | Mag Cover Gasket | \$7.44 | 11060-1189 |
| | | | | | | | EC198018AFM | Outer Clutch Cover Gasket | \$8.69 | 11060-1351 |
| | | | | | | | EC197018AFM | Inner Clutch Cover Gasket | \$16.13 | 11060-1350 |
| | | | | | | | WP037018AFM | Water Pump Gasket | \$3.74 | 11009-1936 |
| | | | | | Clutch & Mag Kit | List Price | Component Part# | Component Description | List Price | OEM Part # |
| | | | C7117CM | \$16.13 | EC198018AFM | Outer Clutch Cover Gasket | \$8.69 | 11060-1351 | | |
| | | | | | EC199018AFM | Mag Cover Gasket | \$7.44 | 11060-1189 | | |
| | | | Crank Seal Kit | List Price | Component Part# | Component Description | List Price | OEM Part # | | |
| | | | C7657 | \$16.99 | OS112 | Right Oil Seal | \$10.68 | 92049-1301 | | |
| | | | | | OS111 | Left Oil Seal | \$8.29 | 92049-1300 | | |



MX/Dirt · Off-Road · ATV Gaskets



Cometic Gasket - An Exclusive NASCAR Performance® Product

KAWASAKI

| Model | Year | Bore Size | Top End Kit | List Price | Component Part# | Component Description | List Price | OEM Part # | | |
|-----------------------|-------------------|------------------------|------------------------------|-------------------|-------------------------------------|------------------------------|------------------------|------------------------------|-------------------|-------------------|
| KX125 | 03 | O-Ring | C7921 | \$38.33 | R93X2B | Outer O-Ring Head Gasket | \$2.79 | 92055-1679 | | |
| | | | | | R62X2V | Inner O-Ring Head Gasket | \$4.64 | 92055-1679 | | |
| | | | | | B0604018AFM | Base Gasket | \$8.69 | 11061-1130 | | |
| | | | | | B0604012F | High Compression Base Gasket | \$8.69 | 11061-1130 | | |
| | | | | | R45X3V | Exhaust O-Ring 2 Req | \$2.71 | 670E3045 | | |
| | | | | | PV120018AFM | Right Power Valve Gasket | \$4.72 | 11061-1132 | | |
| | | | | | PV119018AFM | Front Power Valve Gasket | \$4.72 | 11061-1131 | | |
| | | | | | WA123 | Head Bolt Washers 6 Req | \$1.96 | 11061-1133 | | |
| | | | | | Bottom End Kit w/crank seals | List Price | Component Part# | Component Description | List Price | OEM Part # |
| | | | | | C3350 | \$60.72 | EC756018AFM | Outer Clutch Cover Gasket | \$8.69 | 11061-1135 |
| | | | | | | | EC767018AFM | Inner Clutch Cover Gasket | \$19.82 | 11061-1134 |
| | | | | | | | WP151018AFM | Water Pump Gasket | \$4.72 | 11061-1150 |
| | | | | | | | WP151018AFM | Water Pump Gasket | \$4.72 | 11061-1150 |
| | | | | | Clutch & Mag Kit | List Price | Component Part# | Component Description | List Price | OEM Part # |
| | | | | | C7921CM | \$20.67 | EC756018AFM | Outer Clutch Cover Gasket | \$8.69 | 11061-1135 |
| | | EC199018AFM | Mag Cover Gasket | \$7.44 | 11060-1189 | | | | | |
| Crank Seal Kit | List Price | Component Part# | Component Description | List Price | OEM Part # | | | | | |
| C7657 | \$16.99 | OS112 | Right Oil Seal | \$10.68 | 92049-1301 | | | | | |
| | | OS111 | Left Oil Seal | \$8.29 | 92049-1300 | | | | | |
| KX125 | 04-07 | O-Ring | C7203 | \$38.33 | R93X2B | Outer Head O-Ring | \$2.79 | 92055-1679 | | |
| | | | | | R62X2V | Inner Head O-Ring | \$4.64 | 92053-1678 | | |
| | | | | | B0692018AFM | Base Gasket | \$9.32 | 11061-0039 | | |
| | | | | | B0692012F | High Compression Base Gasket | \$9.32 | 11061-0039 | | |
| | | | | | PV120018AFM | Right Power Valve Gasket | \$4.72 | 11061-1132 | | |
| | | | | | PV119018AFM | Front Power Valve Gasket | \$4.72 | 11061-1131 | | |
| | | | | | R45X3V | Exhaust O-Ring 2 req | \$2.71 | 670E3045 | | |
| | | | | | WA123 | Head Bolt Washers 6 Req | \$1.96 | 11061-1133 | | |
| | | | | | Bottom End Kit w/crank seals | List Price | Component Part# | Component Description | List Price | OEM Part # |
| | | | | | C3350 | \$60.72 | EC756018AFM | Outer Clutch Cover Gasket | \$8.69 | 11061-1135 |
| | | | | | | | EC767018AFM | Inner Clutch Cover Gasket | \$19.82 | 11061-1134 |
| | | | | | | | WP151018AFM | Water Pump Gasket | \$4.72 | 11061-1150 |
| | | | | | Clutch & Mag Kit | List Price | Component Part# | Component Description | List Price | OEM Part # |
| | | | | | C7921CM | \$20.67 | EC756018AFM | Outer Clutch Cover Gasket | \$8.69 | 11061-1135 |
| | | | | | | | EC199018AFM | Mag Cover Gasket | \$7.44 | 11060-1189 |
| Crank Seal Kit | List Price | Component Part# | Component Description | List Price | OEM Part # | | | | | |
| C7657 | \$16.99 | OS112 | Right Oil Seal | \$10.68 | 92049-1301 | | | | | |
| | | OS111 | Left Oil Seal | \$8.29 | 92049-1300 | | | | | |

KDX200/220R

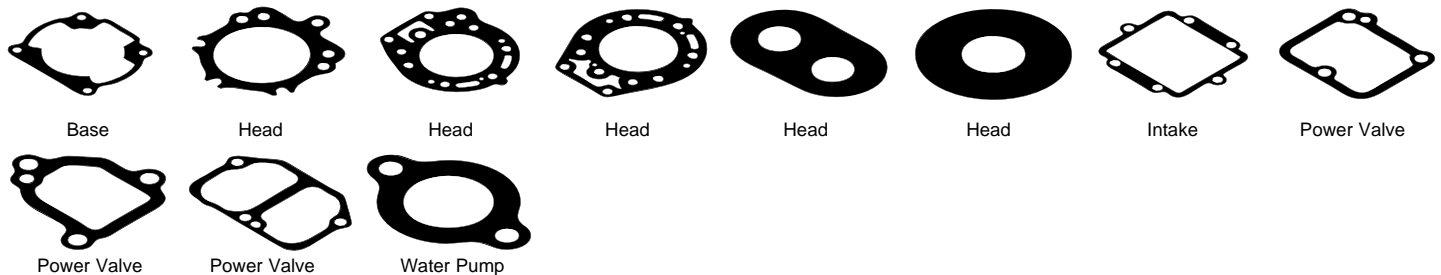

| Model | Year | Bore Size | Top End Kit | List Price | Component Part# | Component Description | List Price | OEM Part # |
|--------|-------|-----------|-------------|------------|-----------------|-----------------------|------------|------------|
| KDX200 | 86-88 | 68 mm | C7042 | \$29.47 | H0019043F | Head Gasket 68mm | \$19.82 | 11009-1141 |
| | | | | | B0023020F | Base Gasket | \$5.34 | 11009-1541 |
| | | | | | IR007018AFM | Intake Gasket | \$3.80 | 11009-1263 |
| | | | | | PV008020F | Power Valve Gasket | \$3.80 | 11009-1542 |

All Component Parts can be purchased individually.



MX/Dirt · Off-Road · ATV Gaskets



Cometic Gasket - An Exclusive NASCAR Performance® Product

KAWASAKI

| Model | Year | Bore Size | Top End Kit | List Price | Component Part# | Component Description | List Price | OEM Part # | |
|-------------|---------|-----------|-------------|------------|-----------------|--------------------------|------------------|------------|------------|
| KDX200 | 89-94 | 68 mm | C7043 | \$42.13 | H0299010S | Head Gasket 68mm | \$30.95 | 11004-1189 | |
| | | 74 mm | C7321 | \$42.13 | H0201043F | Head Gasket 74mm | \$21.76 | | |
| | | | | | H0458020C | Head Insert | \$1.36 | | |
| | | | | | H0457020C | Head Insert | \$1.30 | | |
| | | | | | B0023020F | Base Gasket | \$5.34 | | 11004-1659 |
| | | | | | IR007018AFM | Intake Gasket | \$3.80 | | 11009-1941 |
| | | | | | PV010020F | Right Power Valve Gasket | \$3.80 | | 11009-1934 |
| | | | | | PV009018AFM | Left Power Valve Gasket | \$3.80 | | 11009-1968 |
| | | | | | WP029018AFM | Water Spigot Gasket | \$5.00 | | 11009-1993 |
| KDX200 | 95-06 | 68 mm | C7242 | \$42.13 | H0343010S | Head Gasket 68mm | \$30.95 | 11004-1298 | |
| | | 73 mm | C7320 | \$42.13 | H0399043F | Head Gasket 73mm | \$21.76 | | |
| | | | | | B0203018AFM | Base Gasket | \$5.34 | | 11060-1659 |
| | | | | | IR007018AFM | Intake Gasket | \$3.80 | | 11009-1941 |
| | | | | | PV060018AFM | Left Power Valve Gasket | \$3.80 | | 11060-1628 |
| | | | | | PV047018AFM | Right Power Valve Gasket | \$3.80 | | 11060-1629 |
| | | | | | PV046018AFM | Resonator Cover Gasket | \$3.80 | | 11060-1627 |
| | | | | | WP029018AFM | Water Spigot Gasket | \$5.00 | | 11009-1993 |
| | | | | | R222V | Exhaust Gasket 2 Req | \$3.92 | | 670E3039 |
| | KDX220R | 97-05 | 70 mm | C7298 | \$42.13 | H0439010S | Head Gasket 70mm | | \$30.95 |
| B0203018AFM | | | | | | Base Gasket | \$5.34 | 11060-1659 | |
| IR007018AFM | | | | | | Intake Gasket | \$3.80 | 11009-1941 | |
| PV060018AFM | | | | | | Left Power Valve Gasket | \$3.80 | 11060-1628 | |
| PV047018AFM | | | | | | Right Power Valve Gasket | \$3.80 | 11060-1629 | |
| PV046018AFM | | | | | | Resonator Cover Gasket | \$3.80 | 11060-1627 | |
| R222V | | | | | | Exhaust Gasket 2 Req | \$3.92 | 670E3039 | |

KDX250



Head



Base

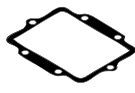

Intake

| Model | Year | Bore Size | Top End Kit | List Price | Component Part# | Component Description | List Price | OEM Part # |
|---------------|-------|-----------|-------------|------------|-----------------|--------------------------|------------|------------|
| KDX250 | 91-94 | 69 mm | C7134 | \$34.27 | H0293010S | Head Gasket 69mm | \$22.83 | 11004-1240 |
| | | | | | B0113018AFM | Base Gasket | \$5.34 | 11060-1493 |
| | | | | | IR008018AFM | Intake Gasket | \$3.80 | 11009-1950 |
| | | | | | PV013018AFM | Front Power Valve Gasket | \$3.80 | 11060-1289 |
| | | | | | PV012020F | Right Power Valve Gasket | \$3.80 | 11060-1290 |
| KL, KLR250 | 85-05 | 77 mm | C7244 | \$34.60 | H0341010C | Head Gasket 77mm | \$28.51 | 11004-1121 |
| | | | | | B0198020F | Base Gasket | \$9.94 | 11060-1125 |
| KLX250R | 94-14 | 73 mm | C7214 | \$30.14 | H0230043F | Head Gasket 73mm | \$24.75 | 11004-1249 |
| | | | | | B0155020RC | Base Gasket | \$8.75 | 11060-1319 |



MX/Dirt · Off-Road · ATV Gaskets



Cometic Gasket - An Exclusive NASCAR Performance® Product

KX250

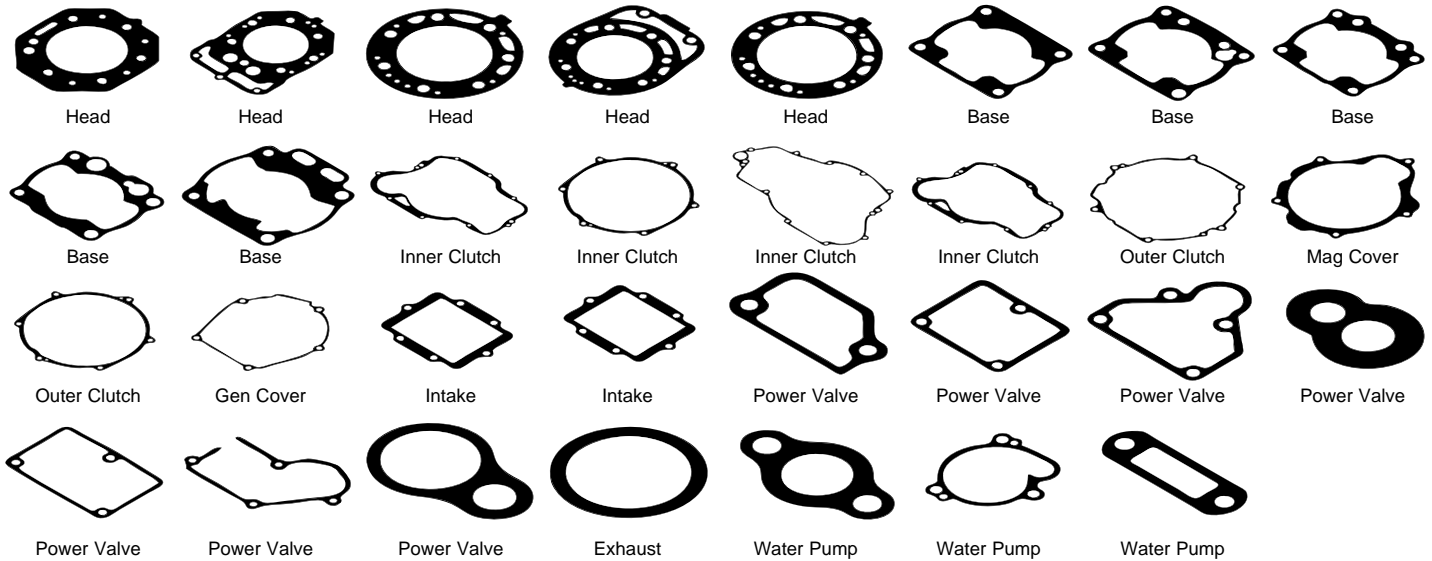

| Model | Year | Bore Size | Top End Kit | List Price | Component Part# | Component Description | List Price | OEM Part # | | |
|------------------|-------|-----------|-------------|------------|----------------------|-----------------------|--------------------|--------------------------|------------|------------|
| KX250 | 83-84 | 72 mm | C7111 | \$23.46 | H0022043F | Head Gasket 72mm | \$19.82 | 11004-1057 | | |
| | | | | | B0025020F | Base Gasket | \$6.25 | 11009-1318 | | |
| KX250 D1 | 85 | 72 mm | C7037 | \$33.45 | OS110 | 20X40X7 Left Oil Seal | \$9.47 | 92049-1052 | | |
| | | | | | | OS113 | Right Oil Seal | \$16.64 | 92049-1051 | |
| | | | | | Crank Seal Kit C7658 | \$27.80 | H0023043F | Head Gasket 72mm | \$21.76 | 11004-1126 |
| | | | | | | | B0025020F | Base Gasket | \$6.25 | 11004-1462 |
| KX250 D2 | 86 | 72 mm | C7038 | \$28.99 | IR008018AFM R136V | Intake Gasket | \$3.80 | 11009-1950 | | |
| | | | | | | Exhaust Gasket 2 Req | \$1.19 | 671E2550 | | |
| | | | | | Crank Seal Kit C7658 | \$27.80 | OS110 | 20X40X7 Left Oil Seal | \$9.47 | 92049-1052 |
| | | | | | | | OS113 | Right Oil Seal | \$16.64 | 92049-1051 |
| KX250 E1 | 87 | 69.5 mm | C7039 | \$32.43 | H0034043F | Head Gasket 69.5mm | \$19.82 | 11004-1157 | | |
| | | | | | | B0032020F | Base Gasket | \$6.25 | 11009-1624 | |
| | | | | | Crank Seal Kit C7658 | \$27.80 | IR008018AFM | Intake Gasket | \$3.80 | 11004-1950 |
| | | | | | | | PV012020F R136V | Right Power Valve Gasket | \$3.80 | 11009-1946 |
| KX250 F1, G1, H1 | 88-90 | 69 mm | C7040 | \$44.69 | R136V | Exhaust Gasket 2 Req | \$1.19 | 671E2550 | | |
| | | | | | | WP030018AFM | Water Inlet Gasket | \$1.93 | 11009-1696 | |
| | | | | | Crank Seal Kit C7658 | \$27.80 | OS110 | 20X40X7 Left Oil Seal | \$9.47 | 92049-1052 |
| | | | | | | | OS113 | Right Oil Seal | \$16.64 | 92049-1051 |



MX/Dirt • Off-Road • ATV Gaskets



Cometic Gasket - An Exclusive NASCAR Performance® Product

KAWASAKI

| Model | Year | Bore Size | Top End Kit | List Price | Component Part# | Component Description | List Price | OEM Part # | | | | | |
|-----------------------------|--------------------------|------------------------|------------------------------|-------------------|-------------------------------------|--------------------------|------------------------|------------------------------|-------------------|-------------------|------------------|---------|------------|
| KX250 H2 | 91 | 69mm | C7041 | \$37.59 | H0293010S | 69mm Head Gasket | \$22.83 | 11004-1217 | | | | | |
| | | | | | B0034020F | Base Gasket | \$6.25 | 11009-1947 | | | | | |
| | | | | | IR008018AFM | Intake Gasket | \$3.80 | 11009-1251 | | | | | |
| | | | | | PV013018AFM | Front Power Valve Gasket | \$3.80 | 11009-1701 | | | | | |
| | | | | | PV012020F | Right Power Valve Gasket | \$3.80 | 11009-1625 | | | | | |
| | | | | | R136V | Exhaust Gasket 2-Req | \$1.19 | 671E2550 | | | | | |
| | | | | | WP030018AFM | Water Inlet Gasket | \$1.93 | 11009-1696 | | | | | |
| | | | | | Crank Seal Kit | List Price | Component Part# | Component Description | List Price | OEM Part # | | | |
| | | | | | C7658 | \$27.80 | OS110 | 20X40X7 Left Oil Seal | \$9.47 | 92049-1051 | | | |
| | | | | | | | OS113 | Right Oil Seal | \$16.64 | 92049-1052 | | | |
| | | | | | KX250 | 92 | 69 mm | C7100 | \$37.59 | H0293010S | Head Gasket 69mm | \$22.83 | 11004-1229 |
| | | | | | | | | | | B0034020F | Base Gasket | \$6.25 | 11009-1947 |
| | | | | | | | | | | IR008018AFM | Intake Gasket | \$3.80 | 11009-1252 |
| PV012020F | Right Power Valve Gasket | \$3.80 | 11009-1625 | | | | | | | | | | |
| PV013018AFM | Front Power Valve Gasket | \$3.80 | 11009-1701 | | | | | | | | | | |
| WP030018AFM | Water Inlet Gasket | \$1.93 | 11009-1696 | | | | | | | | | | |
| R136V | Exhaust Gasket 2 Req | \$1.19 | 671E2550 | | | | | | | | | | |
| Clutch & Mag Kit | List Price | Component Part# | Component Description | List Price | | | | | | OEM Part # | | | |
| C7135CM | \$24.78 | C7478 | Outer Clutch Cover Gasket | \$12.39 | | | | | | 11060-1186 | | | |
| | | EC203018AFM | Mag Cover Gasket | \$12.39 | | | | | | 11009-1951 | | | |
| Crank Seal Kit | List Price | Component Part# | Component Description | List Price | | | | | | OEM Part # | | | |
| C7658 | \$27.80 | OS113 | Right Oil Seal | \$16.64 | | | | | | 92049-1051 | | | |
| | | OS110 | 20X40X7 Left Oil Seal | \$9.47 | | | | | | 92049-1052 | | | |
| KX250 | 88-92 | 68.5 mm | C7135 | \$44.69 | H0253010S | Head Gasket 68.5mm | \$19.82 | 11004-1174 | | | | | |
| | | | | | B0113018AFM | Base Gasket | \$9.32 | 11009-1700 | | | | | |
| | | | | | IR008018AFM | Intake Gasket | \$3.80 | 11009-1252 | | | | | |
| | | | | | PV014018AFM | Right Power Valve Gasket | \$3.80 | 11009-1625 | | | | | |
| | | | | | PV039018AFM | Front Power Valve Gasket | \$3.80 | 11060-1289 | | | | | |
| | | | | | PV040018AFM | Resonator Cover Gasket | \$3.80 | 11060-1290 | | | | | |
| | | | | | R136V | Exhaust Gasket 2 Req | \$1.19 | 671E2550 | | | | | |
| | | | | | WP030018AFM | Water Inlet Gasket | \$1.93 | 11009-1696 | | | | | |
| | | | | | PV067018AFM | Power Valve Rod Gasket | \$3.80 | 11060-1346 | | | | | |
| | | | | | Clutch & Mag Kit | List Price | Component Part# | Component Description | List Price | OEM Part # | | | |
| | | | | | C7135CM | \$24.78 | C7478 | Outer Clutch Cover Gasket | \$12.39 | 11060-1186 | | | |
| | | | | | | | EC203018AFM | Mag Cover Gasket | \$12.39 | 11009-1951 | | | |
| | | | | | Crank Seal Kit | List Price | Component Part# | Component Description | List Price | OEM Part # | | | |
| C7658 | \$27.80 | OS113 | Right Oil Seal | \$16.64 | 92049-1051 | | | | | | | | |
| | | OS110 | 20X40X7 Left Oil Seal | \$9.47 | 92049-1052 | | | | | | | | |
| KX250 | 93 | 68.5 mm | C7135 | \$44.69 | H0253010S | Head Gasket 68.5mm | \$19.82 | 11004-1240 | | | | | |
| | | | | | B0113018AFM | Base Gasket | \$9.32 | 11060-1147 | | | | | |
| | | | | | IR008018AFM | Intake Gasket | \$3.80 | 11009-1252 | | | | | |
| | | | | | PV067018AFM | Power Valve Rod Gasket | \$3.80 | 11060-1290 | | | | | |
| | | | | | PV014018AFM | Right Power Valve Gasket | \$3.80 | 14090-1226 | | | | | |
| | | | | | PV039018AFM | Front Power Valve Gasket | \$3.80 | 11060-1147 | | | | | |
| | | | | | PV040018AFM | Resonator Cover Gasket | \$3.80 | 11060-1289 | | | | | |
| | | | | | R136V | Exhaust Gasket 2 Req | \$1.19 | 671E2550 | | | | | |
| | | | | | Bottom End Kit w/crank seals | List Price | Component Part# | Component Description | List Price | OEM Part # | | | |
| | | | | | C3351 | \$56.99 | EC200018AFM | Inner Clutch Cover Gasket | \$9.94 | 11060-1185 | | | |
| | | | | | | | EC203018AFM | Mag Cover Gasket | \$12.39 | 11009-1951 | | | |
| | | | | | | | C7478 | Outer Clutch Cover Gasket | \$12.39 | 11060-1186 | | | |
| | | | | | | | WP055018AFM | Water Pump Gasket | \$3.74 | 11060-1184 | | | |
| | | WP030018AFM | Water Inlet Gasket | \$1.93 | 11009-1935 | | | | | | | | |
| Clutch & Mag Kit | List Price | Component Part# | Component Description | List Price | OEM Part # | | | | | | | | |
| C7135CM | \$24.78 | C7478 | Outer Clutch Cover Gasket | \$12.39 | 11060-1186 | | | | | | | | |
| | | EC203018AFM | Mag Cover Gasket | \$12.39 | 11009-1951 | | | | | | | | |
| Crank Seal Kit | List Price | Component Part# | Component Part# | List Price | OEM Part# | | | | | | | | |
| C7658 | \$27.80 | OS113 | Right Oil Seal | \$16.64 | 92049-1051 | | | | | | | | |
| | | OS110 | 20X40X7 Left Oil Seal | \$9.47 | 92049-1052 | | | | | | | | |



MX/Dirt · Off-Road · ATV Gaskets



Cometic Gasket - An Exclusive NASCAR Performance® Product

KAWASAKI

| Model | Year | Bore Size | Top End Kit | List Price | Component Part# | Component Description | List Price | OEM Part # | | | | | | | |
|-------------|--------------------------|-----------|-----------------------------|-------------------|------------------------|------------------------------|------------------------|------------------------------|-------------------|-------------------|--------------------|-------------|------------------------------|--------|------------|
| KX250 | 94-00 | 68.5 mm | C7155 | \$44.69 | H0253010S | Head Gasket 68.5mm | \$19.82 | 11004-1240 | | | | | | | |
| | | | | | B0113018AFM | Base Gasket | \$9.32 | 11060-1493 | | | | | | | |
| | | | | 74 mm | C7304 | | B0113012F | High Compression Base Gasket | \$9.32 | 11060-1493 | | | | | |
| | | | | | | | IR008018AFM | Intake Gasket | \$3.80 | 11009-1950 | | | | | |
| | | | | | | | PV014018AFM | Right Power Valve Gasket | \$3.80 | 11009-1960 | | | | | |
| | | | | | | | PV039018AFM | Front Power Valve Gasket | \$3.80 | 11060-1147 | | | | | |
| | | | | | | | PV040018AFM | Resonator Cover Gasket | \$3.80 | 11060-1226 | | | | | |
| | | | | | | | PV067018AFM | Power Valve Rod Gasket | \$3.80 | 11060-1290 | | | | | |
| | | | | | | | R136V | Exhaust Gasket 2 Req | \$1.19 | 92055-1666 | | | | | |
| | | | | | Bottom End Kit | List Price | Component Part# | Component Description | List Price | OEM Part # | | | | | |
| | | | | | w/crank seals | | | | | | | | | | |
| | | | | | C3351 | \$56.99 | EC200018AFM | Inner Clutch Cover Gasket | \$9.94 | 11060-1185 | | | | | |
| | | | | | | | C7478 | Outer Clutch Cover Gasket | \$12.39 | 11060-1186 | | | | | |
| | | | | | | | EC203018AFM | Mag Cover Gasket | \$12.39 | 11009-1951 | | | | | |
| | | | | | | | WP055018AFM | Water Pump Gasket | \$3.74 | 11060-1184 | | | | | |
| | | | | | WP030018AFM | Water Inlet Gasket | \$1.93 | 11009-1935 | | | | | | | |
| | | | Clutch & Mag Kit | List Price | Component Part# | Component Description | List Price | OEM Part # | | | | | | | |
| | | | C7135CM | \$24.78 | C7478 | Outer Clutch Cover Gasket | \$12.39 | 11060-1186 | | | | | | | |
| | | | | | EC203018AFM | Mag Cover Gasket | \$12.39 | 11009-1951 | | | | | | | |
| | | | Crank Seal Kit | List Price | Component Part# | Component Part# | List Price | OEM Part# | | | | | | | |
| | | | C7658 | \$27.80 | OS113 | Right Oil Seal | \$16.64 | 92049-1051 | | | | | | | |
| | | | | | OS110 | 20X40X7 Left Oil Seal | \$9.47 | 92049-1052 | | | | | | | |
| KX250 | 01 | 68.5 mm | C7764 | \$44.69 | H0253010S | Head Gasket 68.5mm | \$19.82 | 11004-0014 | | | | | | | |
| | | | | | H0417010S | Head Gasket 74mm | \$19.82 | 11004-0013 | | | | | | | |
| | | | | 74 mm | C7765 | | B0113018AFM | Base Gasket | \$9.32 | 11060-1493 | | | | | |
| | | | | | | | B0113012F | High Compression Base Gasket | \$9.32 | 11060-1493 | | | | | |
| | | | | | | | IR173018AFM | Intake Gasket | \$3.80 | 11060-1993 | | | | | |
| | | | | | | | PV014018AFM | Right Power Valve Gasket | \$3.80 | 11009-1960 | | | | | |
| | | | | | | | PV039018AFM | Front Power Valve Gasket | \$3.80 | 11060-1289 | | | | | |
| | | | | | | | PV040018AFM | Resonator Cover Gasket | \$3.80 | 11060-1290 | | | | | |
| | | | | | | | PV067018AFM | Power Valve Rod Gasket | \$3.80 | 11060-1346 | | | | | |
| | | | | | | | EX290080C | Exhaust Gasket | \$9.99 | 11060-1689 | | | | | |
| | | | | | | | WP030018AFM | Water Inlet Gasket | \$1.93 | 11009-1935 | | | | | |
| | | | | | | | R136V | Exhaust Gasket 2 Req | \$1.19 | 92055-1666 | | | | | |
| | | KX250 | 02-03 | 68.5 mm | C7861 | \$48.50 | H0253010S | Head Gasket 68.5mm | \$19.82 | 11004-1240 | | | | | |
| | | | | | | | B0113012F | High Compression Base Gasket | \$9.32 | 11060-1493 | | | | | |
| | | | | | | | R49.5X3V | Exhaust O-Ring 2 Req | \$4.29 | 92055-1666 | | | | | |
| B0113018AFM | Base Gasket | | | | | | \$9.32 | 11060-1493 | | | | | | | |
| IR173018AFM | Intake Gasket | | | | | | \$3.80 | 11060-1993 | | | | | | | |
| EX290080C | Exhaust Gasket | | | | | | \$9.99 | 11060-1689 | | | | | | | |
| PV014018AFM | Right Power Valve Gasket | | | | | | \$3.80 | 11009-1960 | | | | | | | |
| PV039018AFM | Front Power Valve Gasket | | | | | | \$3.80 | 11060-1289 | | | | | | | |
| PV040018AFM | Resonator Cover Gasket | | | | | | \$3.80 | 11060-1290 | | | | | | | |
| PV067018AFM | Power Valve Rod Gasket | | | | | | \$3.80 | 11060-1346 | | | | | | | |
| KX250 | 04 | | | | | | 68.5 mm | C7269 | \$53.37 | H2155010S | Head Gasket 68.5mm | \$19.82 | 11004-0013 | | |
| | | | | | | | | | | H2156010S | Head Gasket 70.5mm | \$19.82 | 11061-0040 | | |
| | | | | | | | | | 70.5 mm | C7284 | | B0743018AFM | Base Gasket | \$9.32 | 11061-0040 |
| | | | | | | | | | | | | B0743012F | High Compression Base Gasket | \$9.32 | 11061-0040 |
| | | | | | | | | | | | | IR173018AFM | Intake Gasket | \$3.80 | 11060-1993 |
| | | | | | | | EX290080C | Exhaust Gasket | \$9.99 | 11060-1689 | | | | | |
| | | | | | | | PV014018AFM | Right Power Valve Gasket | \$3.80 | 11009-1960 | | | | | |
| | | | | | | | PV039018AFM | Front Power Valve Gasket | \$3.80 | 11060-1289 | | | | | |
| | | | | | | | PV040018AFM | Resonator Cover Gasket | \$3.80 | 11060-1290 | | | | | |
| | | | | | | | PV067018AFM | Power Valve Rod Gasket | \$3.80 | 11060-1346 | | | | | |
| | | | | | | | R017B | Power Valve O-Ring 2 Req | \$1.14 | 11060-1346 | | | | | |
| | | | | | | | R49.5X3V | Exhaust O-Ring 2 Req | \$4.29 | 92055-1666 | | | | | |



MX/Dirt • Off-Road • ATV Gaskets



Cometic Gasket - An Exclusive NASCAR Performance® Product

KAWASAKI

| Model | Year | Bore Size | Bottom End Kit w/Oil Seals | List Price | Component Part# | Component Description | List Price | OEM Part # | | | | | |
|-------------|---|-------------------|----------------------------|------------------------------|-----------------|---------------------------|---------------------|-----------------------------|---------------------------------------|------------------------|------------------------------|-------------------|-------------------|
| KX250 | 97-04 | | C7861BE | \$77.73 | WA108 | Drain Plug Gasket | \$2.56 | 92065-058 | | | | | |
| | | | | | EC202020F | Inner Clutch Cover Gasket | \$17.38 | 11061-1058/ 11060-1749 | | | | | |
| | | | | | | WP165020F | Water Pump Gasket | \$3.85 | 11061-0057 | | | | |
| | | | | | | WP117020F | Water Outlet Gasket | \$2.56 | 11060-1183 | | | | |
| | | | | | | Oil Seal Kit | List Price | Component Part# | Component Description | List Price | OEM Part # | | |
| | | | | | | C7861OS | \$48.58 | OS110 | Left Crank Seal 20x40x7 | \$9.47 | 92049-0032/ 92049-1554 | | |
| | | | | | | | | OS187 | Right Crank Seal 25x45x7 | \$16.64 | 92049-0031/ 92049-1555 | | |
| | | | | | | | | OS285 | Kickstart Shaft Seal 02-07 20x30x7 | \$1.48 | 92049-1594 | | |
| | | | | | | | | OS295 | Output Shaft Seal 30x40x7 | \$9.89 | 92049-0030/ 92049-1556 | | |
| | | | | | | | | OS306 | Clutch Pushrod Seal 11.5x18x4 | \$2.91 | 92049-1262 | | |
| | | | | | | | | OS307 | Kickstart Shaft Seal 83-01 18x30x7 | \$7.03 | 92049-013 | | |
| | | | | | | | | OS331 | Shift Shaft Seal 13x22x5.5 | \$3.71 | 92051-005 | | |
| | | | | | | | | OS360 | Impeller Seal 8x18x3.5 | \$5.31 | 92049-0033 | | |
| | | | | | | | | OS361 | Water Pump Shaft Seal 7x18x9.5 | \$9.43 | 92049-0034 | | |
| | | | | | | | | OS362 | Power Valve Governor Seal 8x14x4 | \$4.51 | 92049-1207 | | |
| | | | | | | | | OS369 | Power Valve Shaft Seal 5.5X11X4 | \$4.30 | 92049-1206 | | |
| | | | | | | | | Clutch & Mag Kit | List Price | Component Part# | Component Description | List Price | OEM Part # |
| | | | | | | | | C3174CM | \$24.80 | EC203020F | Mag Cover Gasket | \$12.39 | 11060-1352 |
| | | | | | | | | | | EC201020F | Outer Clutch Cover Gasket | \$12.39 | 11060-1494 |
| | | | | | KX250 | 05-07 | 66.6 mm | Top End Kit C3096 | List Price \$24.91 | R103X2V | Outer Head O-Ring | \$5.29 | 92055-0050 |
| R74X2S | Inner Head O-Ring | \$3.57 | 92055-0049 | | | | | | | | | | |
| B0818018AFM | Base Gasket | \$9.70 | 11061-0091 | | | | | | | | | | |
| B0818014RC | High Compression Base Gasket | \$9.70 | 11061-0091 | | | | | | | | | | |
| R53.5X2V | Exhaust O-Ring 2 Req | 3.07 ea. | 92055-0052 | | | | | | | | | | |
| EX290080C | Exhaust Gasket | \$9.99 | 11061-0142 | | | | | | | | | | |
| PV128018AFM | Front Power Valve Gasket | \$4.72 | 11061-0092 | | | | | | | | | | |
| PV129018AFM | Left Power Valve Gasket | \$4.72 | 11061-0093 | | | | | | | | | | |
| PV130018AFM | Power Valve Gasket 2 Req | \$1.13 | 11061-0138 | | | | | | | | | | |
| WA123 | Head Bolt Washers 6 Req | \$1.96 | 11061-1133 | | | | | | | | | | |
| R8.5X2V | R8.5X2V | \$1.10 | | | | | | | | | | | |
| | Bottom End Kit w/cranks seals | List Price | Component Part# | Component Description | | | | | | List Price | OEM Part # | | |
| | C3353 | \$63.47 | EC1031018AFM | Inner Clutch Cover Gasket | | | | | | \$20.22 | 11061-0095 | | |
| | | | EC1032032AFM | Outer Clutch Cover Gasket | | | | | | \$14.31 | 11061-0144 | | |
| | | | EC1033032AFM | Mag Cover Gasket | | | | | | \$9.47 | 11061-0098 | | |
| | | | WP151018AFM | Water Pump Cover Gasket | | | | | | \$4.72 | 11061-0097 | | |
| | Clutch & Mag Kit | List Price | Component Part# | Component Description | | | | | | List Price | OEM Part # | | |
| | C3096CM | \$23.78 | EC1032032AFM | Outer Clutch Cover Gasket | | | | | | \$14.31 | 11061-0144 | | |
| | | | EC1033032AFM | Mag Cover Gasket | | | | | | \$9.47 | 11061-0098 | | |
| | Crank Seal Kit | List Price | Component Part# | Component Description | | | | | | List Price | OEM Part # | | |
| | C7773 | \$27.80 | OS187 | Right Oil Seal | \$16.64 | 92049-0031 | | | | | | | |
| | | | OS110 | 20X40X7 Left Oil Seal | \$9.47 | 92049-0032 | | | | | | | |



MX/Dirt · Off-Road · ATV Gaskets



Cometic Gasket - An Exclusive NASCAR Performance® Product

KX250F

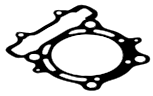

Head



Head



Head

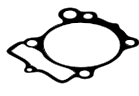

Base



Exhaust

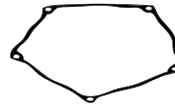

Outer Clutch



Inner Clutch

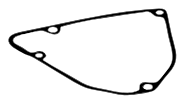

Head

| Model | Year | Bore Size | EST | List Price | Component Part# | Component Description | List Price | OEM Part # | |
|--------|-------|-----------|-----------|------------|-----------------|-----------------------|---------------------------|------------|------------|
| KX250F | 04-08 | 77 mm | C3174-EST | \$74.99 | H2169SP1027S | Head Gasket 77mm | \$43.39 | 11004-0003 | |
| | | 78 mm | C3054-EST | \$74.99 | H2096027S | Head Gasket 78mm | \$43.39 | | |
| | | 80 mm | C3056-EST | \$74.99 | H2169027S | Head Gasket 80mm | \$43.39 | | |
| | | 81mm | C7221-EST | \$74.99 | H1967027S | Head Gasket 81mm | \$43.39 | | |
| | | 83 mm | C3135-EST | \$74.99 | H2471SP1027S | Head Gasket 83mm | \$43.39 | | |
| | | 84 mm | C3118-EST | \$74.99 | H2471027S | Head Gasket 84mm | \$43.39 | | |
| | | | | | | B0691014RC | Base Gasket | \$20.99 | 11061-0025 |
| | | | | | | EX651 | Exhaust Gasket | \$8.98 | 11061-0027 |
| | | | | | | R018B | Camchain Tensioner O-Ring | \$3.92 | 92055-086 |
| | | | | | | 3233V | Valve Stem Seal 4 Req | \$5.11 ea. | 92049-1349 |

| Bottom End Kit w/Oil Seals | List Price | Component Part# | Component Description | List Price | OEM Part # |
|----------------------------|------------|-----------------|------------------------------|------------|------------|
| C3174BE | \$98.69 | WA108 | Crank Case Drain Plug Washer | \$2.56 | 92065-058 |
| | | R118B | Crank End Cap O-Ring | \$1.13 | 670B2022 |
| | | EC903032AFM | Inner Clutch Cover Gasket | \$20.99 | 11061-0030 |
| | | R112B | Timing Mark Plug O-Ring | \$3.92 | 92055-1141 |
| | | R117B | Crank Case Oil Fill O-Ring | \$0.42 | 92055-1146 |
| | | R018B | Output Shaft O-Ring (2) | \$3.92 | 92055-055 |
| | | MR042 | Water Pump Cover O-Ring | \$3.40 | 92055-0010 |
| | | R116B | Water Pipe O-Ring | \$1.13 | 92055-1308 |

| Oil Seal Kit | List Price | Component Part# | Component Description | List Price | OEM Part # |
|--------------|------------|-----------------|------------------------------------|------------|------------|
| C3174OS | \$45.36 | OS279 | Decompression Shaft Seal 10x18x5 | \$1.48 | 92049-1196 |
| | | OS295 | Crank Seal 30x40x7 | \$9.89 | 92049-1556 |
| | | OS305 | Shift Shaft Seal 14x22x6 | \$5.77 | 92049-0015 |
| | | OS306 | Clutch Actuator Shaft Seal 12x18x4 | \$2.91 | 92049-1262 |
| | | OS307 | Start Shaft Seal 18x30x7 | \$7.03 | 92049-013 |
| | | OS308 | Impeller Seal 8x22x7x7.5 | \$5.89 | 92049-0021 |
| | | OS309 | Inner WP Seal 8x22x5 | \$5.89 | 92049-0016 |
| | | OS359 | Output Shaft Seal 25x40x6 | \$3.83 | 92049-1478 |

| Clutch & Mag Kit | List Price | Component Part# | Component Description | List Price | OEM Part # |
|------------------|------------|-----------------|---------------------------|------------|------------|
| C3174CM | \$24.80 | EC847060AFM | Outer Clutch Cover Gasket | \$11.18 | 11061-0031 |
| | | EC904032AFM | Mag Cover Gasket | \$13.62 | 11061-0032 |
| | | VC102 | Valve Cover Gasket | \$18.51 | 11061-0024 |



MX/Dirt · Off-Road · ATV Gaskets



Cometic Gasket - An Exclusive NASCAR Performance® Product

KAWASAKI

| Model | Year | Bore Size | EST Top End Kit | List Price | Component Part# | Component Description | List Price | OEM Part # | | |
|--------|-------|-----------|-----------------------------|-------------------|---|------------------------------|----------------------------|------------------------------|-------------------|-------------------|
| KX250F | 09-16 | 78mm | C3267-EST | \$74.99 | H2848027S | Head Gasket 78mm | \$43.39 | 11004-0079 | | |
| | | | 79mm | C3274-EST | \$74.99 | H2848SP3027S | Head Gasket 79mm | \$43.39 | | |
| | | | 80mm | C3271-EST | \$74.99 | H2848SP1027S | Head Gasket 80mm | \$43.39 | | |
| | | | | | | B0967020RC | Base Gasket | \$20.99 | 11061-0357 | |
| | | | | | | EX651 | Exhaust Gasket | \$8.98 | 11061-0027 | |
| | | | | | | R018B | Cam Chain Tensioner O-Ring | \$3.92 | 92055-086 | |
| | | | | | | 3183V | Valve Stem Seals 4 Req | \$5.50 | 92049-1349 | |
| | | | | | | R021V | Cam Tower O-ring | \$1.19 | 92055-0046 | |
| | | | | | | R013V | Water Temp Sensor O-Ring | \$1.08 | 92055-0016 | |
| | | | | | Bottom End Kit w/o crank seals | List Price | Component Part# | Component Description | List Price | OEM Part # |
| | | | | | C3418 | \$32.74 | R014V | Timing Mark Plug O-Ring | \$1.08 | 92055-1011 |
| | | | | | | | R20X2V | Fill Plug O-ring | \$3.02 | 92055-1146 |
| | | | | | | | R27.5X2.5V | Crank End Plug O-ring | \$2.45 | 92055-091 |
| | | | | | | | EC1312032AFM | Outer Clutch Cover Gasket | \$11.18 | 11061-0362 |
| | | | | | EC1341032AFM | Inner Clutch Cover Gasket | \$13.57 | 11061-0361 | | |
| | | | | | EC1340032AFM | Mag Cover Gasket | \$13.62 | 11061-0363/ 11061-0778 | | |
| | | | | | WA108 | Drain Plug Gasket | \$2.56 | 92065-058 | | |
| | | | Clutch & Mag Kit | List Price | Component Part# | Component Description | List Price | OEM Part # | | |
| | | | C3267CM | \$24.80 | EC1312032AFM | Outer Clutch Cover Gasket | \$11.18 | 11061-0362 | | |
| | | | | | EC1340032AFM | Mag Cover Gasket | \$13.62 | 11061-0363/ 11061-0778 | | |

KXT250



Head Head Base Base Intake

| Model | Year | Bore Size | Top End Kit | List Price | Component Part# | Component Description | List Price | OEM Part # | | | | |
|--------------------|-------|-----------|-------------|------------|-----------------|---------------------------|--------------------|------------|------------|--------------|---------------------|---------|
| KXT250 Tecate | 83-85 | 72 mm | C7049 | \$23.46 | H0022043F | Head Gasket 72mm | \$19.82 | 11004-1057 | | | | |
| | | 76 mm | C7326 | \$23.46 | H0022SP1043F | Head Gasket 76mm | \$19.82 | | | | | |
| | | | | | B0025020F | Base Gasket | \$6.25 | 11009-1318 | | | | |
| KXT250 Tecate | 86 | 72 mm | C7050 | \$24.48 | H0023043F | Head Gasket 72mm | \$21.76 | 11004-1144 | | | | |
| | | 76 mm | C7322 | \$24.48 | H0197043F | Head Gasket 76mm | \$21.76 | | | | | |
| | | | | | | B0026020F | Base Gasket | \$6.25 | 11009-1546 | | | |
| | | | | | | IR008018AFM | Intake Gasket | \$3.80 | 11009-1050 | | | |
| | | | | | R136V | Exhaust O-Ring | \$1.19 | 671E2550 | | | | |
| KFX250 Mojave | 87-05 | 77 mm | C7244 | \$34.60 | B0198020F | Base Gasket | \$9.94 | 11060-1125 | | | | |
| | | | | | H0341010C | 77mm Head Gasket | \$28.51 | 11004-1121 | | | | |
| | | | | | | | | | | | | |
| | | | | | EC618020F | Clutch Cover Gasket | \$16.13 | 11060-1238 | | | | |
| KLF250 Bayou | 88-06 | 70 mm | C7243-EST | \$63.14 | H0261040S | Head Gasket 70mm | \$24.75 | 11004-1375 | | | | |
| | | | | | B0169020F | Base Gasket | \$7.44 | 11061-1104 | | | | |
| | | | | | EX692064AM | Exhaust Gasket | \$2.56 | 11009-1866 | | | | |
| | | | | | R10X2V | Valve Guide O-Ring 2 Req | \$1.59 | 92055-1177 | | | | |
| | | | | | R95X2V | Cam Sprocket Cover O-Ring | \$4.00 | 671B2595 | | | | |
| | | | | | R70X2S | Cylinder O-Ring | \$3.21 | 92055-1672 | | | | |
| | | | | | R32X3V | Intake O-Ring 2 Req | \$3.57 | 92055-1256 | | | | |
| | | | | | R118B | Cam Tensioner O-Ring | \$1.13 | 670B2021 | | | | |
| | | | | | R227V | Rocker Cap O-Ring 2 Req | \$3.92 | 92055-112 | | | | |
| | | | | | 3241V | Valve Stem Seals 2 Req | \$3.46 | 92049-1062 | | | | |
| | | | | | | | | | | | | |
| | | | | | | | | | | EC1088032AFM | Clutch Cover Gasket | \$28.57 |
| KXF250 Tecate 4 | 87-88 | 69.5 mm | C7039 | \$32.43 | H0034043F | Head Gasket 69.5 | \$19.82 | 11004-1157 | | | | |
| | | 74 mm | C7323 | \$32.43 | H0204043F | Head Gasket 74mm | \$19.82 | | | | | |
| | | | | | | B0032020F | Base Gasket | \$6.25 | 11009-1624 | | | |
| | | | | | | IR008018AFM | Intake Gasket | \$3.80 | 11009-1252 | | | |
| | | | | | | PV012020F | Power Valve Gasket | \$3.80 | 11009-1625 | | | |
| | | | | | | R136V | Exhaust O-Ring | \$1.19 | 671E2525 | | | |



MX/Dirt · Off-Road · ATV Gaskets



Cometic Gasket - An Exclusive NASCAR Performance® Product

KLX300



| Model | Year | Bore Size | Top End Kit | List Price | Component Part# | Component Description | List Price | OEM Part # |
|---------|-------|-----------|-------------|------------|-----------------|-----------------------|------------|------------|
| KLX300R | 97-05 | 78 mm | C7302 | \$27.89 | H0252043F | Head Gasket 78mm | \$24.75 | 11004-1314 |
| | | 80 mm | C7420 | \$27.89 | H0521043F | Head Gasket 80mm | \$24.75 | |
| | | | | | B0260020RC | Base Gasket | \$6.25 | 11060-1740 |

KLF300

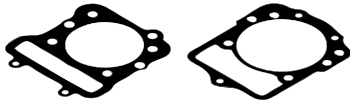

| Model | Year | Bore Size | Top End Kit | List Price | Component Part# | Component Description | List Price | OEM Part # |
|------------------|-------|-----------|-------------|------------|-----------------|-------------------------|-------------|------------|
| KLF300 | 86-87 | 77 mm | C7245 | \$29.59 | H0256043F | Head Gasket | \$23.57 | 11004-1136 |
| | | | | | B0163020F | Base Gasket | \$9.32 | 11060-1221 |
| KEF300 | 97-03 | 79 mm | C7248 | \$32.81 | B0163020F | Base Gasket | \$9.32 | 11060-1652 |
| Lakota | 92-03 | | | | H0256020C | Head Gasket 79mm | \$27.14 | 11004-1183 |
| KLF300 | | | | | Component Part# | Component Description | List Price | OEM Part # |
| KLF300 Bayou 4x4 | 89-05 | | | | EC598020F | Clutch Cover Gasket 2WD | \$14.65 | 11060-1655 |
| | | | EST | List Price | Component Part# | Component Description | List Price | OEM Part # |
| KLX 400 | 03-04 | 92 mm | C7688-EST | \$64.23 | H0949027S | Head Gasket 92mm | \$30.95 | 11004-S006 |
| | | 94 mm | C7806-EST | \$64.23 | H1045027S | Head Gasket 94mm | \$30.95 | |
| | | 95mm | C7963-EST | \$64.23 | H1699027S | Head Gasket 95mm | \$30.95 | |
| | | 97 mm | C7980-EST | \$64.23 | H1046027S | Head Gasket 97mm | \$30.95 | |
| | | | | | | B0440010RC | Base Gasket | \$8.69 |
| | | | | | EX243 | Exhaust Gasket | \$2.79 | 11061-S076 |
| | | | | | EC377032AFM | Cam Tensioner Gasket | \$3.35 | 11061-S073 |
| | | | | | WA121 | Oil Check Washer | \$0.80 | 11061-S006 |
| | | | | | 3160V | Valve Stem Seal 4 Req | \$5.50 | 92049-S006 |
| | | | | | Component Part# | Component Part# | List Price | OEM Part # |
| | | | | | EC837032AFM | Clutch Cover | \$13.29 | 92055-S080 |
| KLF400 | 93-02 | 84.5 mm | C7249 | \$43.99 | H0340010C | Head Gasket | \$35.60 | 11004-1233 |
| Bayou 4x4 | | | | | B0201020F | Base Gasket | \$9.94 | 11060-1205 |
| KVF400 | 99-02 | | | | | | | |

KFX400

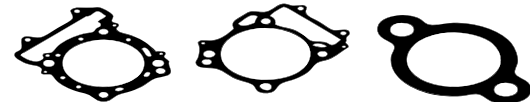

| Model | Year | Bore Size | EST | List Price | Component Part# | Component Description | List Price | OEM Part # |
|--------|-------|-----------|------------------|------------|-----------------|------------------------|-------------|------------|
| KFX400 | 03-06 | 92 mm | C7978-EST | \$64.23 | H0949027S | Head Gasket 92mm | \$30.95 | 11004-S006 |
| | | 94 mm | C7979-EST | \$64.23 | H1045027S | Head Gasket 94mm | \$30.95 | |
| | | 96 mm | C3138-EST | \$64.23 | H1045SP2027S | Head Gasket 96mm | \$30.95 | |
| | | 97 mm | C7980-EST | \$64.23 | H1046027S | Head Gasket 97mm | \$30.95 | |
| | | | | | | B0440027S | Base Gasket | \$28.51 |
| | | | | | EX243 | Exhaust Gasket | \$2.79 | 11061-S076 |
| | | | | | EC377032AFM | Cam Tensioner Gasket | \$3.35 | 11061-S073 |
| | | | | | WA121 | Oil Drain Bolt Gasket | \$0.80 | 11061-S005 |
| | | | | | 3160V | Valve Stem Seals 4 Req | \$5.50 | 92049-S006 |
| | | | Clutch & Mag Kit | List Price | Component Part# | Component Description | List Price | OEM Part # |
| | | | C7978CM | \$33.41 | EC1030032AFM | Clutch Cover Gasket | \$20.22 | 11061-S071 |
| | | | | | EC1034032AFM | Mag Cover Gasket | \$12.99 | 11061-S072 |
| | | | | | Component Part# | Component Part# | List Price | OEM Part# |
| | | | | | EC1030032AFM | Clutch Cover Gasket | \$20.22 | 11061-S071 |
| | | | | | EC1034032AFM | Mag Cover Gasket | \$12.99 | 11061-S072 |

All Component Parts can be purchased individually.



MX/Dirt · Off-Road · ATV Gaskets



Cometic Gasket - An Exclusive NASCAR Performance® Product

KX450F



Head



Base



Inner Clutch

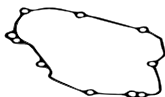

Generator Cover



Exhaust

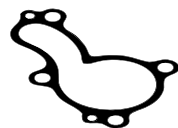

Water Pump



Cam Chain Tensioner



Outer Clutch

| Model | Year | Bore Size | EST | List Price | Component Part# | Component Description | List Price | OEM Part # |
|--------|-------|-----------------------------|--------------------|-----------------------------------|-----------------------------------|----------------------------|------------------------------|-------------------|
| KX450F | 06-08 | 96 mm | Top End Kit | | | | | |
| | | | C3136-EST | \$69.14 | H2466027S | Head Gasket 96.5mm | \$43.54 | 11004-0045 |
| | | 98 mm | C3146-EST | \$69.14 | H2466SP1027S | Head Gasket 98mm | \$43.54 | 11004-0045 |
| | | | | | B0842014RC | Base Gasket | \$11.81 | 11061-0160 |
| | | | | | EX693064AM | Exhaust Gasket | \$2.56 | 11061-0082 |
| | | | | | EC1080032AFM | Cam Tensioner Gasket | \$2.33 | 11061-0260 |
| | | | | | R022B | Spark Plug O-Ring | \$1.13 | 11061-0079 |
| | | | | | R10X2V | Cam Chain Tensioner O-Ring | \$1.59 | 670D2010 |
| | | | | | 3241V | Valve Stem Seals 4 Req | \$3.46 | 92049-1062 |
| | | | | Bottom End Kit w/Oil Seals | List Price | Component Part# | Component Description | List Price |
| | | C3136BE | \$91.63 | R10X2B | Cam Chain O-ring | \$1.59 | 670D2010 | |
| | | | | R010B | Oil Nozzle O-ring 7mm | \$0.62 | 670D1507 | |
| | | | | WA108 | Drain Plug Washer | \$2.56 | 92065-058 | |
| | | | | R123V | Crankshaft Timing O-Ring | \$2.45 | 92055-091 | |
| | | | | R014V | Timing Plug O-ring | \$1.08 | 92055-1011 | |
| | | | | EC1067032AFM | Outer Clutch Cover Gasket | \$10.73 | 11061-0145 | |
| | | | | R118B | Crankcase Oil Fill O-Ring | \$1.13 | 92055-1146 | |
| | | | | EC1068032AFM | Inner Clutch Cover Gasket | \$7.44 | 11061-0224 | |
| | | | | R123V | Neutral Switch O-Ring | \$2.45 | 92055-091 | |
| | | | | R138SB | Oil Filter O-Ring 2 Req | \$5.71 | 92055-1577 | |
| | | | | R10X2B | Oil Pickup O-ring | \$1.59 | 670D2010 | |
| | | | | WP187032AFM | Water Pump Gasket | \$4.72 | 11061-0225 | |
| | | Oil Seal Kit | List Price | Component Part# | Component Description | List Price | OEM Part # | |
| | | C3136OS | \$25.84 | OS295 | Output Shaft Seal 30x40x7 | \$9.89 | 92049-0030 | |
| | | | | OS339 | Clutch Release Oil Seal 12X20X5.5 | \$2.59 | 92049-1475 | |
| | | | | OS331 | Shift Shaft Seal 13x22x5.5 | \$3.71 | 92051-005 | |
| | | | | OS227 | Inner Water Pump Seal 12x22x5 | \$2.67 | 92049-0041 | |
| | | | | OS277 | Outer Water Pump Seal 12x24x7 | \$1.48 | 92049-0040 | |
| | | | | OS285 | Kickstart Shaft Seal 20x30x7 | \$1.48 | 92049-1261 | |
| | | | | OS275 | Crank End Oil Seal 10x20x5 | \$4.02 | 92049-1542 | |
| | | Clutch & Mag Kit | List Price | Component Part# | Component Description | List Price | OEM Part # | |
| | | C3136CM | \$23.72 | EC1067032AFM | Clutch Cover Gasket | \$10.73 | 11061-0145 | |
| | | | | EC1081018AFM | Mag Cover Gasket | \$12.99 | 11061-0084 | |



MX/Dirt · Off-Road · ATV Gaskets



Cometic Gasket - An Exclusive NASCAR Performance® Product

KAWASAKI

| Model | Year | Bore Size | EST | List Price | Component Part# | Component Description | List Price | OEM Part# |
|-----------------------------------|-------|--------------|-----------------------------------|-------------------|------------------------|-----------------------------------|-------------------|-----------------------|
| KX450F | 09-15 | 96mm 98mm | Top End Kit | | | | | |
| | | | C3268-EST | \$69.14 | H2466027S | Head Gasket 96.5mm | \$43.54 | 11004-0045/ 110040088 |
| | | | C3285-EST | \$69.14 | H2466SP1027S | Head Gasket 98mm | \$43.54 | |
| | | | | | B0966014RC | Base Gasket | \$11.81 | 11061-0353/11061-0768 |
| | | | | | EX693064AM | Exhaust Gasket | \$2.56 | 11061-0082 |
| | | | | | EC1080032AFM | Cam Tensioner Gasket | \$2.33 | 11061-0211 |
| | | | | | R022B | Spark Plug O-Ring | \$1.13 | 11061-0079 |
| | | | | | R10X2V | Cam Chain Tensioner O-Ring | \$1.59 | 670D2010 |
| | | | | | 3241V | Valve Stem Seals 4 Req | \$3.46 | 92045-1062 |
| | | | | | | | | |
| Bottom End Kit w/Oil Seals | | | | | | | | |
| | | | Bottom End Kit w/Oil Seals | List Price | Component Part# | Component Description | List Price | OEM Part # |
| | | | C3268BE | \$98.69 | R020V | Output Shaft O-ring | \$1.19 | 92055-1293 |
| | | | | | R013V | Temp Sensor O-ring | \$1.08 | 92055-0016 |
| | | | | | R010B | Oil Nozzle O-ring 7mm | \$0.62 | 670D1507 |
| | | | | | R011B | Oil Nozzle O-ring 8mm | \$1.08 | 670D1508 |
| | | | | | WA118 | Left Case Drain Crush Washer | \$1.88 | 92022-304 |
| | | | | | WA108 | Drain Plug Crush Washer | \$2.56 | 92065-058 |
| | | | | | EC1338032AFM | Clutch Cover Gasket | \$17.84 | 11061-0359 |
| | | | | | R010B | Case Dowel O-Ring | \$0.62 | 92055-0113 |
| | | | | | R123V | Crank End Plug O-ring | \$1.19 | 92055-091 |
| | | | | | R014V | Timing Plug O-ring | \$1.08 | 92055-1011 |
| | | | | | R20X2V | Oil Fill Plug O-ring | \$3.02 | 92055-1146 |
| | | | | | R123V | Neutral Switch O-ring | \$1.19 | 92055-091 |
| | | | | | R138SB | Oil Filter O-rings | \$5.71 | 92055-1577 |
| | | | | | R10X2B | Oil Pickup O-ring | \$1.59 | 670D2010 |
| | | | | | WP187032AFM | Water Pump Gasket | \$4.72 | 11061-0225 |
| | | | | | WA118 | Water Pump Drain Washer | \$1.88 | 92022-304 |
| Oil Seal Kit | | | | | | | | |
| | | | Oil Seal Kit | List Price | Component Part# | Component Description | List Price | OEM Part # |
| | | | C3268OS | \$25.84 | OS277 | Outer Water Pump Seal 12x24x7 | 1.48 | 92049-0040 |
| | | | | | OS227 | Inner Water Pump Seal 12x22x5 | 2.67 | 92049-0041 |
| | | | | | OS285 | Kickstart Shaft Seal 20x30x7 | 1.48 | 92049-0134 |
| | | | | | OS275 | Crank End Oil Seal 10x20x5 | 4.02 | 92049-1542 |
| | | | | | OS295 | Output Shaft Seal 30x40x7 | 9.89 | 92049-0030 |
| | | | | | OS339 | Clutch Release Oil Seal 12X20X5.5 | 2.59 | 92049-1475 |
| | | | | | OS331 | Shift Shaft Seal 13x22x5.5 | 3.71 | 92051-005 |
| Clutch & Mag Kit | | | | | | | | |
| | | | Clutch & Mag Kit | List Price | Component Part# | Component Description | List Price | OEM Part # |
| | | | C3268CM | \$24.86 | EC1184032AFM | Outer Clutch Cover Gasket | \$11.87 | 11061-0259 |
| | | | | | EC1339032AFM | Mag Cover Gasket | \$12.99 | 11061-0358 |
| | | | | | | | | |
| KX450F | 2016 | 96mm | EST | | | | | |
| | | | Top End Kit | | | | | |
| | | | C3598-EST | \$69.14 | H2466027S | Head Gasket | \$43.54 | 11004-0756 |
| | | | | | B1320014RC | Base Gasket | \$11.81 | 11061-0984 |
| | | | | | EC1080032AFM | Cam Chain Tensioner Gasket | \$2.33 | 11061-0260 |
| | | | | | R10X2V | Cam Chain Tensioner O-Ring | \$1.59 | 670D2010 |
| | | | | | R021V | Cam Tower O-ring | \$1.19 | 92055-0046 |
| | | | | | EX693064AM | Exhaust Gasket | \$2.56 | 11061-0082 |
| | | 3241V | Valve Stem Seals 4 Req | \$3.46 | 92045-1062 | | | |



MX/Dirt · Off-Road · ATV Gaskets



Cometic Gasket - An Exclusive NASCAR Performance® Product

KAWASAKI

| Model | Year | Bore Size | EST | List Price | Component Part# | Component Description | List Price | OEM Part # | |
|-----------------------------|-------|-----------------------------------|-------------------|------------|------------------------|------------------------------|----------------------------|-------------------|------------|
| KFX450R | 09-14 | 96 mm | Top End Kit | | | | | | |
| | | | C3201-EST | \$69.14 | H2466027S | Head Gasket 96.5mm | \$43.54 | 11004-0073 | |
| | | 98 mm | C3202-EST | \$69.14 | H2466SP1027S | Head Gasket 98mm | \$43.54 | | |
| | | | | | B0911020RC | Base Gasket | \$11.81 | 11061-0234 | |
| | | | | | | EC1080032AFM | Cam Tensioner Gasket | \$2.33 | 11061-0260 |
| | | | | | | R013B | Water Temp O-Ring | \$1.19 | 92055-0016 |
| | | | | | | R022V | Spark Plug O-Ring | \$1.19 | 92055-0046 |
| | | | | | | R10X2V | Cam Chain Tensioner O-Ring | \$1.59 | 670D2010 |
| | | | | | | 3241V | Valve Stem Seals 4 Req | \$3.46 | 92049-1062 |
| | | Bottom End Kit w/Oil Seals | | | | | | | |
| | | | List Price | | Component Part# | Component Description | List Price | OEM Part # | |
| | | | \$102.16 | | R011B | Case Oil Feed O-ring | \$1.13 | 670D1508 | |
| | | | | | WA108 | Drain Plug Seal | \$2.56 | 92065-097 | |
| | | | | | R20X2V | Clutch Fill Plug O-ring | \$3.02 | 92055-1146 | |
| | | | | | R141SB | Oil Pump Cover O-ring | \$18.99 | 92055-0110 | |
| | | | | | R015V | Timing Plug O-ring | \$1.13 | 92055-1141 | |
| | | | | | R123V | Crank Plug O-ring | \$1.19 | 92055-091 | |
| | | | | | R138SB | Oil Filter O-rings (2) | \$5.71 | 92055-1577 | |
| | | | | | R008B | Oil Line O-rings (3) | \$0.11 | 670D1505 | |
| | | | | | EC1185032AFM | Inner Clutch Cover Gasket | \$28.57 | 11061-0236 | |
| | | | | | R010B | Oil Pipe O-rings (2) | \$0.62 | 670D1507 | |
| | | | | | R214B | Starter Motor O-ring | \$0.51 | 92055-1276 | |
| | | | | | WP209018AFM | Water Pump Cover | \$4.72 | 11061-0237 | |
| | | | | | WA118 | Water Pump Bolt Seal | \$1.88 | 92022-304 | |
| Oil Seal Kit | | | | | | | | | |
| | | | List Price | | Component Part# | Component Description | List Price | OEM Part # | |
| | | | \$24.36 | | OS331 | Shift Shaft Seal | \$3.71 | 92051-005 | |
| | | | | | OS339 | Clutch Shaft Seal | \$2.59 | 92049-1475 | |
| | | | | | OS295 | Out Put Shaft Seal 30x40x7 | \$9.89 | 92049-0030 | |
| | | | | | OS277 | Oil Pump Seal 12x24x7 | \$1.48 | 92049-0040 | |
| | | | | | OS227 | Water Pump Seal 12x22x5 | \$2.67 | 92049-0041 | |
| | | | | | OS275 | Clutch Pushrod Seal 10x20x5 | \$4.02 | 92049-1542 | |
| Clutch & Mag Kit | | | | | | | | | |
| | | | List Price | | Component Part# | Component Description | List Price | OEM Part # | |
| | | | \$38.72 | | EC1184032AFM | Clutch Cover | \$11.87 | 11061-0259 | |
| | | | | | EC1183032AF | Mag Cover Gasket | \$26.65 | 11061-0235 | |

KX500

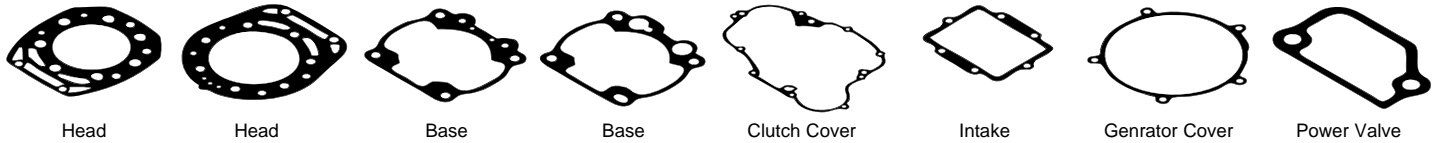

| Model | Year | Bore Size | Top End Kit | List Price | Component Part# | Component Description | List Price | OEM Part # | | | |
|--------------|-------|-----------|----------------|------------|-----------------|--------------------------|------------|-------------|-------------------------|---------|-----------------|
| KX500 B2, C1 | 86-88 | 88 mm | C7045 | \$34.35 | H0036043F | Head Gasket 88mm | \$22.32 | 11004-1140 | | | |
| | | | | | B0035020F | Base Gasket | \$7.16 | 11009-1537 | | | |
| | | | | | IR008018AFM | Intake Gasket | \$3.80 | 11009-1950 | | | |
| | | | | | PV014018AFM | Right Power Valve Gasket | \$3.80 | 11009-1960 | | | |
| | | | | | R136V | Exhaust O-Ring 2 Req | \$1.19 | | | | |
| | | | Bottom End Kit | C3356 | \$39.94 | C7495 | \$10.22 | C7495 | Clutch cover Gasket | \$10.22 | 11009-1540/1963 |
| | | | | | | | | EC255018AFM | Mag Cover Gasket | \$12.39 | 11009-1289/1964 |
| | | | | | | | | WP048018AFM | Water Pump Cover Gasket | \$3.80 | 11009-1466/1962 |
| | | | Crank Seal Kit | C7659 | \$19.22 | OS135 | \$10.68 | OS135 | Oil Seal 2 Req | \$10.68 | 92050-057 |
| | | | | | | | | WP050018AFM | Water Pipe Gasket | \$2.44 | 11009-1446 |



MX/Dirt · Off-Road · ATV Gaskets



Cometic Gasket - An Exclusive NASCAR Performance® Product

KAWASAKI

| Model | Year | Bore Size | Top End Kit | List Price | Component Part# | Component Description | List Price | OEM Part # | | | |
|---------------------------|------|-----------|------------------------|----------------------------|-------------------|------------------------------|-------------------|------------------------|------------------------------|-------------------|-------------------|
| KX500 E1, 89-90 E2 | | 88 mm | C7046 | \$37.84 | H0037043F | Head Gasket 88mm | \$22.32 | 11004-1186 | | | |
| | | | | | B0036018AFM | Base Gasket | \$7.16 | 11009-1758 | | | |
| | | | | | B0036012F | High Compression Base Gasket | \$9.32 | | | | |
| | | | | | IR008018AFM | Intake Gasket | \$3.80 | 11009-1252 | | | |
| | | | | | PV013018AFM | Front Power Valve Gasket | \$3.80 | 11009-1701 | | | |
| | | | | | PV014018AFM | Right Power Valve Gasket | \$3.80 | 11009-1539 | | | |
| | | | | | R136V | Exhaust O-Ring 2 Req | \$1.19 | 671E2550 | | | |
| | | | | | | Bottom End Kit | List Price | Component Part# | Component Part# | List Price | OEM Part# |
| | | | | | | C3356 | \$39.94 | C7495 | Clutch Cover Gasket | \$10.22 | 11009-1540 |
| | | | | | | | | EC255018AFM | Mag Cover Gasket | \$12.39 | 11009-1289 |
| | | | | | | | | WP048018AFM | Water Pump Cover Gasket | \$3.80 | 11009-1466 |
| | | | | | | | | WP050018AFM | Water Pipe Gasket | \$2.44 | 11009-1446 |
| | | | | | | | | Component Part# | Component Part# | List Price | OEM Part# |
| | | | OS135 | Oil Seal 2 Req | \$10.68 | 92050-057 | | | | | |
| KX500 E3, 91-04 T2, R2 | | 88 mm | C7047 | \$43.26 | H0306010S | Head Gasket 88mm | \$22.32 | 11004-1209 | | | |
| | | | | | B0036018AFM | Base Gasket | \$7.16 | 11060-1874 | | | |
| | | | | | B0036012F | High Compression Base Gasket | \$7.16 | | | | |
| | | | | | IR008018AFM | Intake Gasket | \$3.80 | 11009-1950 | | | |
| | | | | | PV013018AFM | Front Power Valve Gasket | \$3.80 | 11009-1948 | | | |
| | | | | | PV014018AFM | Right Power Valve Gasket | \$3.80 | 11009-1960 | | | |
| | | | | | R136V | Exhaust O-Ring 2 Req | \$1.19 | 671E2550 | | | |
| | | | | | | Bottom End Kit | List Price | Component Part# | Component Part# | List Price | OEM Part# |
| | | | | | | C3356 | \$39.94 | C7495 | Clutch Cover Gasket | \$10.22 | 11009-1540/1963 |
| | | | | | | | | EC255018AFM | Mag Cover Gasket | \$12.39 | 11009-1289/1964 |
| | | | | | | | | WP048018AFM | Water Pump Cover Gasket | \$3.80 | 11009-1466/1962 |
| | | | | | | | | Component Part# | Component Description | List Price | OEM Part # |
| | | | | | | | | C7495 | Clutch Cover Gasket | \$10.22 | 11009-1540/1963 |
| | | | EC255018AFM | Mag Cover Gasket | \$12.39 | 11009-1289/1964 | | | | | |
| | | | Component Part# | Component Part# | List Price | OEM Part# | | | | | |
| | | | OS135 | Left/Right Oil Seal 2 Req. | \$10.68 | 92050-057 | | | | | |

KLX650

| Model | Year | Bore Size | Top End Kit | List Price | Component Part# | Component Description | List Price | OEM Part # |
|--------------------|-------|-----------|-------------|------------|-----------------|-----------------------|------------|------------|
| KLX650, KLX650R | 93-97 | 100 mm | C7246 | \$38.33 | H0259043F | Head Gasket 103mm | \$30.95 | 11004-1158 |
| | | | | | B0166020RC | Base Gasket | \$8.75 | 11060-1110 |



MX/Dirt · Off-Road · ATV Gaskets



Cometic Gasket - An Exclusive NASCAR Performance® Product

KVF650/KRF750

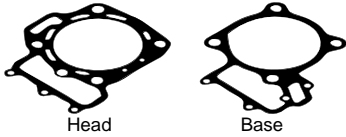

| Model | Year | Bore Size | EST Top End Kit | List Price | Component Part# | Component Description | List Price | OEM Part # |
|-------------|-------|-----------|--------------------|------------|-----------------|-------------------------|------------|------------|
| KVF650 | 01-03 | 81 mm | C7981-EST | \$101.70 | H1893010S | Head Gasket 81mm 2 Req | \$24.75 | 11004-1373 |
| Prairie 4x4 | | 83 mm | C7982-EST | \$101.70 | H1894010S | Head Gasket 83mm 2 Req | \$24.75 | 11004-1373 |
| KFX700 | 04-07 | 84 mm | C3125-EST | \$101.70 | H1894SP7010S | Head Gasket 84mm 2 Req | \$24.75 | 11004-1373 |
| V Force | | 85 mm | C7173-EST | \$101.70 | H1983010S | Head Gasket 85mm 2 Req | \$24.75 | 11004-1384 |
| KVF700 | 04-07 | 87 mm | C3163-EST | \$101.70 | H2513SP1010S | Head Gasket 87mm 2 Req | \$24.75 | |
| Prairie | | 89 mm | C3162-EST | \$101.70 | H2513010S | Head Gasket 89mm 2 Req | \$24.75 | |
| | | 90mm | C3212-EST | \$101.70 | H2513SP3010S | Head Gasket 90mm 2 Req | \$24.75 | |
| | | | | | B0677020RC | Base Gasket 2 Req | \$9.94 | 11060-1965 |
| | | | | | EX361 | Exhaust Gasket 2 Req | \$5.50 | 11009-1894 |
| | | | | | R129B | Intake O-Rings 2 Req | \$1.13 | 92055-1295 |
| | | | | | R140V | Rocker Cap O-Ring 4 Req | \$3.29 | 92055-1644 |
| | | | | | R14X2.5V | Oil Cap O-Ring | \$1.13 | 670D2014 |
| | | | | | R16X2V | Water Pipe O-Ring 2 Req | \$3.02 | 670B2016 |
| | | | | | 3242V | Valve Stem Seals 8 Req | \$3.02 | 92049-1218 |

| Model | Year | Bore Size | EST Top End Kit | List Price | Component Part# | Component Description | List Price | OEM Part # |
|---------|-------|-----------|--------------------|------------|-----------------|----------------------------|------------|------------|
| KVF750 | 08-16 | 85mm | C3284-EST | \$122.60 | H2624SPA010S | Head Gasket 85mm | \$28.29 | 11004-0011 |
| Prairie | | 90 mm | C3251-EST | \$122.60 | H2624SP1010S | Head Gasket 90mm | \$28.29 | 11004-0011 |
| | | | | | B0951020RC | Base Gasket | \$9.94 | 11061-0063 |
| | | | | | EX361 | Exhaust Gasket 2 req | \$5.50 | 11009-1894 |
| | | | | | WA114 | Coolant Drain Washer 2 Req | \$3.02 | |
| | | | | | R55X2V | Rocker Cap O-Ring 4 Req | \$2.34 | 92055-0112 |
| | | | | | R19X2V | Plug Cover O-Ring 2 Req | \$2.50 | 92055-1146 |
| | | | | | 3242V | Valve Stem Seals 8 Req | \$3.02 | 92049-1218 |

KTM 50 94-01

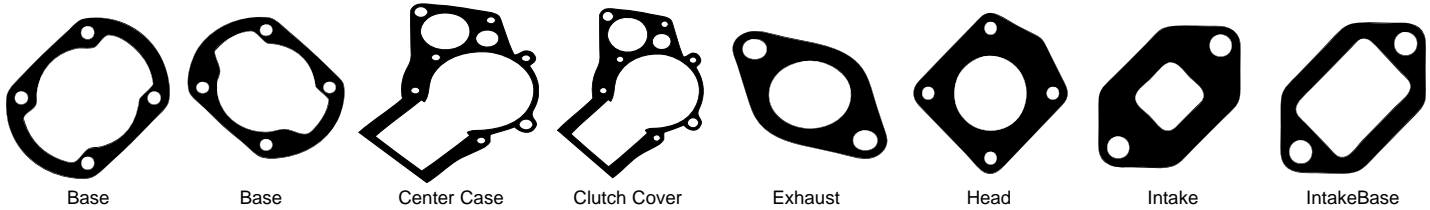

| Model | Year | Bore Size | Top End Kit | List Price | Component Part# | Component Description | List Price | OEM Part # |
|--|-------|-----------|---|-------------------|------------------------|------------------------------|-------------------|------------------|
| 50 Mini, Junior & Senior Adventure | 94-01 | 41 mm | C7282 | \$31.91 | H0354010C | Head Gasket .010" Copper | \$9.37 | 36330036000 |
| | | | | | H0354020C | Head Gasket .020" Copper | \$9.37 | 36330036000 |
| | | | | | B0219018AFM | Base Gasket 00-01 | \$4.65 | 45030035800 |
| | | | | | B0220018AFM | Base Gasket 94-99 | \$4.65 | 36330030000 |
| | | | | | IR054018AFM | Intake Port Small Opening | \$3.80 | 49130438000 |
| | | | | | IR055018AFM | Intake Port Large Opening | \$3.80 | 49130438000 |
| | | | | | EX089039F | Exhaust Gasket | \$4.77 | 45030046000 |
| | | | Bottom End Kit w/o Crank Seals | List Price | Component Part# | Component Description | List Price | OEM Part# |
| | | | C3381 | \$8.16 | EC073015F | Center Case Gasket | \$4.54 | 45030039000 |
| | | | | | EC074032AFM | Clutch Cover Gasket | \$4.54 | 45030025000 |



MX/Dirt · Off-Road · ATV Gaskets



Cometic Gasket - An Exclusive NASCAR Performance® Product

KTM 50 02-07

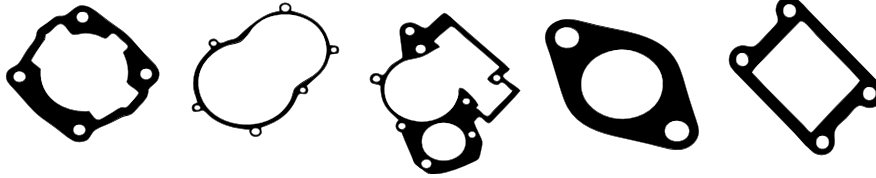

| Model | Year | Bore Size | Top End Kit | List Price | Component Part# | Component Description | List Price | OEM Part # |
|-------------------|-------|-----------|---------------------------------------|-------------------|------------------------|------------------------------|-------------------|-------------------|
| 50 Mini Adventure | 02-08 | 41 mm | C7292 | \$31.91 | H2287010C | Head Gasket .010" Copper | \$5.50 | 46030046000 |
| | | | | | B0357032AFM | Base Gasket .032" AFM | \$6.25 | 46030035020 |
| | | | | | IR115032AFM | Intake Gasket .032" | \$6.25 | 46030049000 |
| | | | | | R32X3V | Exhaust Pipe O-ring | \$3.57 | 0770320030 |
| | | | | | | | | |
| | | | Bottom End Kit w/o Crank Seals | List Price | Component Part# | Component Description | List Price | OEM Part # |
| | | | C3382 | \$17.99 | EC517018AFM | Clutch Cover Gasket | \$9.32 | 45130025000 |
| | | | | | EC659015F | Center Case Gasket | \$10.68 | 45130039000 |
| | | | | | EC992060AFM | Oil Fill Plug Gasket | \$7.00 | 45130019000 |
| | | | | | WA130 | 6 req. Head Seal Washers | \$1.36 | 0125060003 |

50 SXR

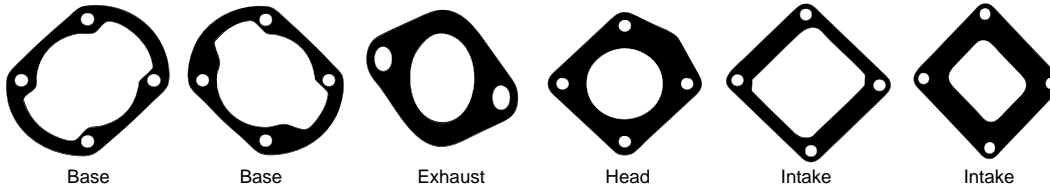

| Model | Year | Bore Size | Top End Kit | List Price | Component Part# | Component Description | List Price | OEM Part # |
|------------------|-------|-----------|-------------|------------|-----------------|-----------------------|------------|-------------|
| 50 SXR Pro Jr/Sr | 97-01 | 43 mm | C7415 | \$31.91 | H1197010C | Head Gasket .010 | \$9.37 | 36330036000 |
| | | | | | H1197020C | Head Gasket .020 | \$9.37 | 36330036000 |
| | | | | | B0219018AFM | Base Gasket 99-01 | \$4.65 | 36330030000 |
| | | | | | B0220018AFM | Base Gasket 94-98 | \$4.65 | 45030035800 |
| | | | | | IR109018AFM | Intake to Reed Gasket | \$3.80 | 45030057800 |
| | | | | | IR110018AFM | Intake to Case Gasket | \$3.80 | 45030049900 |
| | | | | | EX175060F | Exhaust Gasket | \$4.77 | 45030046800 |

50 LC

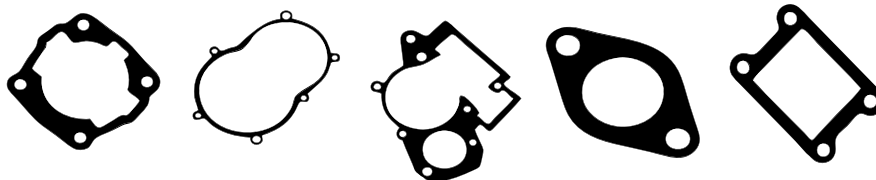

| Model | Year | Bore Size | Top End Kit | List Price | Component Part# | Component Description | List Price | OEM Part # | | | | | |
|-----------------|-------|-----------|-------------|------------|-----------------|---|------------|---------------------------------------|-------------------|------------------------|------------------------------|-------------------|------------------|
| 50 LC Pro Jr/Sr | 01-01 | O-Ring | C7863 | \$36.86 | R034V | Inner Head O-ring | \$3.00 | 46030037000 | | | | | |
| | | | | | R044B | Outer Head O-ring | \$2.14 | 46030036000 | | | | | |
| | | | | | WA130 | 6 Req. Head Seal Washers | \$1.36 | 0125060003 | | | | | |
| | | | | | B0357012F | Base Gasket .012 | \$6.25 | 46030035020 | | | | | |
| | | | | | B0357018AFM | Base Gasket .018 | \$6.25 | 45130025000 | | | | | |
| | | | | | IR115018AFM | Intake Gasket | \$6.25 | 45130039000 | | | | | |
| | | | | | EX089039F | Exhaust Flange Gasket | \$4.77 | 46030049000 | | | | | |
| | | | | | R32X3V | Exhaust Pipe O-ring | \$3.57 | 0770320030 | | | | | |
| | | | | | | | | | | | | | |
| | | | | | | | | Bottom End Kit w/o Crank Seals | List Price | Component Part# | Component Description | List Price | OEM Part# |
| | | | | | | | | C3383 | \$22.82 | EC517018AFM | Clutch Cover | \$9.32 | 45130025000 |
| | | | | | | | | | | EC659015F | Center Case Gasket | \$10.68 | 45130039000 |
| | | | | | | | | | | EC992060AFM | Oil Fill Plug Gasket | \$1.13 | 45130019000 |
| | | | | | WA129 | Case Drain Crush Washer 10mm x 14mm x 2mm | \$0.95 | 0603100141 | | | | | |
| | | | | | WA133 | Clutch & Water Pump Drain Crush washers 2 Req. | \$0.90 | 0603061001 | | | | | |



MX/Dirt · Off-Road · ATV Gaskets



Cometic Gasket - An Exclusive NASCAR Performance® Product

KTM 50 PRO SENIOR LC

| Model | Year | Bore Size | Top End Kit | List Price | Component Part# | Component Description | List Price | OEM Part # |
|---------------|-------|-----------|-----------------------------------|------------|-----------------|---|------------|-------------|
| 50 SX | 02-08 | O-Ring | C7295 | 38.33 | R53.5X2V | Inner Head O-ring | \$3.07 | 46030036000 |
| Pro Senior LC | | | | | R95X2V | Outer Head O-ring | \$4.00 | 46030037000 |
| | | | | | WA130 | Head Crush Washer 5 Req. | \$1.36 | 50230032010 |
| | | | | | B0357032AFM | Base Gasket | \$6.25 | 46030035020 |
| | | | | | IR115032AFM | Intake Gasket | \$6.25 | 46030049000 |
| | | | | | EX175060F | Exhaust Gasket | \$4.77 | 46030046000 |
| | | | Bottom End Kit w/o Crank Seals | List Price | Component Part# | Component Description | List Price | OEM Part # |
| | | | C3383 | 22.82 | EC517018AFM | Clutch Cover | \$9.32 | 45130025000 |
| | | | | | EC659015F | Center Case Gasket | \$10.68 | 45130039000 |
| | | | | | EC992060AFM | Oil Fill Plug Gasket | \$1.13 | 45130019000 |
| | | | | | WA129 | Case Drain Crush Washer | \$0.95 | 0603100141 |
| | | | | | WA133 | Clutch & Water Pump Drain Crush Washers 2 Req. | \$0.90 | 0603061001 |

50 SX LC

| Model | Year | Bore Size | Top End Kit | List Price | Component Part# | Component Description | List Price | OEM Part # |
|---------|-------|-----------|-------------|------------|-----------------|---|------------|-------------|
| 50SX LC | 09-16 | O-Ring | C3503 | \$28.94 | R52X2V | Inner Head O-ring | \$3.36 | 0770052020 |
| | | | | | R78X2V | Outer Head O-ring | \$4.29 | 0770078020 |
| | | | | | WA130 | Head Crush Washer 5 Req. 7.5mm x 12mm x .5mm | \$1.36 | 50230032010 |
| | | | | | EX14B043F | Exhaust Gasket | \$5.75 | 45205004000 |
| | | | | | B0976018AFM | Base Gasket | \$6.25 | 46230035040 |

65 SX



Base

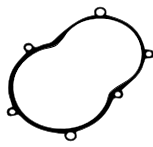

Clutch Cover

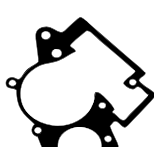

Center Case



Exhaust

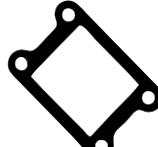

Intake

| Model | Year | Bore Size | Top End Kit | List Price | Component Part# | Component Description | List Price | OEM Part # |
|-------|-------|-----------|-----------------------------------|------------|-----------------|--|------------|-------------|
| 65 SX | 98-01 | O-Ring | C7416 | \$35.72 | R034V | Inner Head O-ring | \$3.00 | 46030036000 |
| | | | | | R044B | Outer Head O-ring | \$2.14 | 46030037000 |
| | | | | | B0357012F | Base Gasket .012" | \$6.25 | 46030035020 |
| | | | | | B0357018AFM | Base Gasket .018" | \$6.25 | 46030035020 |
| | | | | | IR115018AFM | Intake Reed Gasket | \$6.25 | 46030049000 |
| | | | Bottom End Kit w/o Crank Seals | List Price | Component Part# | Component Description | List Price | OEM Part # |
| | | | C3384 | \$36.35 | EC447032AFM | Inner Clutch Cover | \$14.87 | 46030025000 |
| | | | | | EC448020F | Crankcase Gasket | \$16.13 | 46030039000 |
| | | | | | R048B | Mag Cover O-ring | \$11.34 | 0770020480 |
| | | | | | WP106032AFM | Water Pump Gasket | \$2.16 | 45135053000 |
| 65 SX | 02-08 | O-Ring | C7333 | \$38.33 | R54X2V | Inner Head O-ring | \$4.14 | 46030036000 |
| | | | | | R95X2V | Outer Head O-ring | \$4.00 | 46030037000 |
| | | | | | WA130 | Head Crush Washer 5 Req. | \$1.36 | 50230032010 |
| | | | | | B0357018AFM | Base Gasket .018" | \$6.25 | 46030035020 |
| | | | | | B0357032AFM | Base Gasket .032" | \$6.25 | 46030035020 |
| | | | | | IR115032AFM | Intake Gasket | \$6.25 | 46030049000 |
| | | | | | EX921059F | Exhaust Gasket | \$4.77 | 46030046000 |
| | | | Bottom End Kit w/o Crank Seals | List Price | Component Part# | Component Description | List Price | OEM Part # |
| | | | C3385 | \$49.61 | EC447032AFM | Inner Clutch Cover | \$14.87 | 46030025000 |
| | | | | | EC448020F | Crankcase Gasket | \$16.13 | 46030039000 |
| | | | | | R048B | Mag Cover O-ring | \$11.34 | 0770020480 |
| | | | | | R16X3V | Clutch Fill Plug O-ring | \$1.26 | 0770160030 |
| | | | | | R19X2V | Output Shaft O-ring | \$2.50 | 46033031000 |
| | | | | | R30X1.5V | Clutch Slave Cylinder O-ring | \$2.29 | 0770300015 |
| | | | | | WA129 | Case Drain Crush Washer 10mm x 14mm x 2mm | \$0.95 | 0603101420 |
| | | | | | WP106032AFM | Water Pump Gasket | \$2.16 | 45135053000 |



MX/Dirt · Off-Road · ATV Gaskets



Cometic Gasket - An Exclusive NASCAR Performance® Product

KTM

| Model | Year | Bore Size | Top End Kit | List Price | Component Part# | Component Description | List Price | OEM Part |
|-------|-------|-----------|-------------|------------|-----------------|--------------------------------|------------|-------------|
| 65 SX | 09-16 | O-Ring | C3416 | \$35.51 | MR106 | Cylinder Head Gasket | \$6.90 | 45230036000 |
| | | | | | WA146 | Head Crush Washer 4 Req. | \$2.16 | 50230032010 |
| | | | | | B0976018AFM | Cylinder Base Gasket | \$6.25 | 46230035040 |
| | | | | | EX943059F | Header Flange Gasket | \$4.77 | 46205004000 |
| | | | | | R20X2V | Power Valve Control O-ring | \$3.02 | 770150151 |
| | | | | | R005B | Power Valve Base Orings 2 Req. | \$0.11 | 770030015 |
| | | | | | WA133 | Power Valve Base Seal Washer | \$0.90 | 603061001 |
| | | | | | WA133 | Power Valve Copper Seal | \$0.90 | 603050901 |
| | | | | | IR747018AFM | Reed Valve Gasket | \$4.37 | 46230049000 |

KTM 85 SX

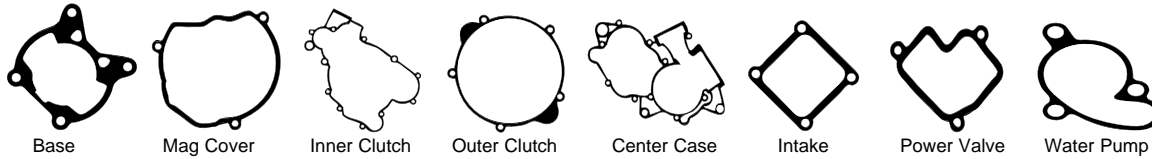

| Model | Year | Bore Size | Top End Kit | List Price | Component Part# | Component Description | List Price | OEM Part # |
|-------|-------|-----------|---------------------------------------|-------------------|------------------------|--|-------------------|-------------------|
| 85 SX | 04-12 | O-Ring | C7384 | \$38.33 | R54X2V | Inner Head O-ring | \$4.14 | 0770 540020 |
| | | | | | R82X2V | Outer Head O-ring | \$5.14 | 0770 820020 |
| | | | | | R22X2.5V | Head Insert O-ring | \$2.21 | 0770 220025 |
| | | | | | WA133 | Head Seal Crush Washers 6 Req. | \$0.90 | 0603061001 |
| | | | | | B0801032AFM | Base Gasket | \$7.16 | 47030035000 |
| | | | | | WA134 | Exhaust Valve Seal Crush Washer | \$0.80 | 0603040801 |
| | | | | | PV126032AFM | Power Valve Side Cover Gasket | \$4.72 | 47037008000 |
| | | | | | R12X2V | Exhaust Control Valve O-ring | \$4.09 | 0770120020 |
| | | | | | R8X1.5V | Exhaust Valve Linkage O-ring | \$0.59 | 0770008015 |
| | | | | | IR530032AFM | Intake Gasket | \$4.72 | 47030049000 |
| | | | | | R22X2V | Exhaust Valve Cover O-ring | \$2.66 | 0770020200 |
| | | | | | R38X3V | Exhaust Pipe Header O-rings 2 req. | \$3.79 | 0770380030 |
| | | | Bottom End Kit w/o Crank Seals | List Price | Component Part# | Component Description | List Price | OEM Part # |
| | | | C3386 | \$38.43 | EC986032AFM | Mag Cover Gasket | \$3.18 | 47030040000 |
| | | | | | EC987032AFM | Inner Clutch Cover Gasket | \$7.49 | 47030025000 |
| | | | | | EC988032AFM | Outer Clutch Cover Gasket | \$5.11 | 47030027000 |
| | | | | | EC989020F | Crankcase Gasket | \$10.17 | 47030039000 |
| | | | | | R16X3V | Oil Fill Plug Gasket | \$1.26 | 0770160030 |
| | | | | | R19X2V | Output Shaft O-ring | \$2.50 | 46033031000 |
| | | | | | R30X1.5V | Clutch Slave Cylinder O-ring | \$2.29 | 0770300015 |
| | | | | | WA133 | Water Pump Seal Crush Washer | \$0.90 | 0603061001 |
| | | | | | WP174032AFM | Water Pump Gasket | \$4.72 | 47035053000 |
| | | | Clutch & Mag Kit | List Price | Component Part# | Component Description | List Price | OEM Part # |
| | | | C7384CM | \$8.29 | EC988032AFM | Clutch Cover Gasket | \$5.11 | 47030027000 |
| | | | | | EC986032AFM | Mag Cover Gasket | \$3.18 | 47030040000 |
| | | | Top End Kit | List Price | Component Part# | Component Part# | List Price | OEM Part# |
| 85 SX | 13-16 | O-Ring | C3510 | \$28.63 | R54X2V | Inner Head O-ring 54X2 | \$4.14 | 0770540020 |
| | | | | | R80X2S | Outer Head O-ring 80X2 | \$5.29 | 0770800021 |
| | | | | | PV143018AFM | Right Power Valve Gasket | \$3.59 | 47137008000 |
| | | | | | WA133 | Copper Head Crush Washer | \$0.90 | 0603061001 |
| | | | | | B0801032AFM | Base Gasket .2mm | \$7.16 | 47030035020 |
| | | | | | R12X2V | Power Valve Control O-ring Left 12x2 | \$4.09 | 0770120020 |
| | | | | | R8X1.5V | Power Valve Control O-ring Right 8x1.5 | \$0.59 | 0770008015 |
| | | | | | R22X2V | Power Valve Control Cover O-ring | \$2.66 | 0770020200 |
| | | | | | R38X3V | Exh. Pipe Header O-rings 2 req | \$3.79 | 0770380030 |
| | | | Bottom End Kit | List Price | Component Part# | Component Part# | List Price | OEM Part# |
| | | | C3517 | \$38.43 | EC989020F | Center Case Gasket | \$10.17 | 47030039000 |
| | | | | | EC987032AFM | Inner Clutch Cover Gasket | \$7.49 | 47030025000 |
| | | | | | EC1849032AFM | Outer Clutch Cover Gasket | \$5.11 | 47030027100 |
| | | | | | R16X3V | Oil Fill Plug O-ring | \$1.26 | 0770160030 |
| | | | | | WA129 | Drain Plug gasket | \$0.95 | 0603101420 |
| | | | | | WP429018AFM | Water Pump Cover Gasket | \$4.72 | 47035053000 |
| | | | | | WA133 | Water Pump Cover Drain | \$0.90 | 0603061001 |



MX/Dirt • Off-Road • ATV Gaskets



Cometic Gasket - An Exclusive NASCAR Performance® Product

KTM 105SX

| Model | Year | Bore Size | Top End Kit | List Price | Component Part# | Component Description | List Price | OEM Part |
|-------|-------|-----------|-------------|------------|-----------------|---|------------|-------------|
| 105SX | 07-11 | O-Ring | C3552 | 28.63 | MR124 | Inner Head O-ring | 8.99 | 47530006000 |
| | | | | | R80X2S | Outer Head O-ring 80X2 | 5.29 | 0770800021 |
| | | | | | PV143018AFM | Right Power Valve Gasket | 3.59 | 47137008000 |
| | | | | | WA133 | Copper Head Crush Washer | 0.90 | 0603061001 |
| | | | | | B0801032AFM | Base Gasket .2mm | 7.16 | 47030035020 |
| | | | | | R12X2V | Power Valve Control O-ring Left 12x2 | 4.09 | 0770120020 |
| | | | | | R8X1.5V | Power Valve Control O-ring Right 8x1.5 | 0.59 | 0770008015 |
| | | | | | R22X2V | Power Valve Control Cover O-ring | 2.66 | 0770020200 |
| | | | | | R38X3V | Exhaust Pipe Header O-rings 2 req. | 3.79 | 0770380030 |

125/200 SX

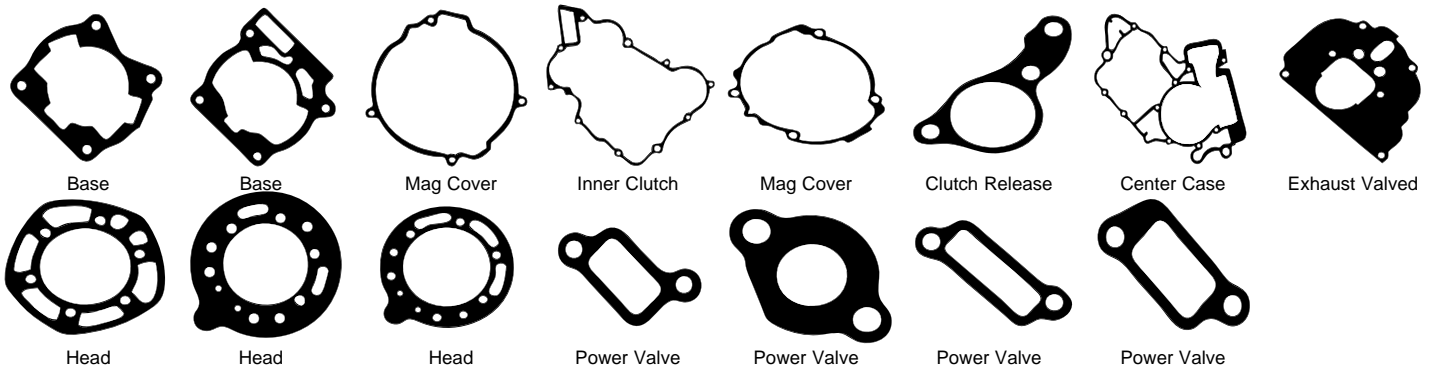

| Model | Year | Bore Size | Top End Kit | List Price | Component Part# | Component Description | List Price | OEM Part # |
|----------------|-------|-----------|--------------------------------|------------------------------|---------------------------------|---|------------------------------|-------------------------------|
| 125 SX, EXC | 93-96 | O-Ring | C7097 | \$31.91 | R60X2V | Inner Head O-ring | \$4.84 | 50230095000 |
| | | | | | H0377043F | Head Gasket Outer | \$17.38 | 50230036500 |
| | | | | | B0228018AFM | Base Gasket .018" AFM | \$6.25 | 50230030020 |
| | | | | | B0228032AFM | Base Gasket .032" AFM | \$6.25 | 50230030030 |
| | | | | | PV048018AFM | Power Valve Gasket | \$3.80 | 50237006000 |
| | | | Crank Seal Kit C7660 | List Price \$28.81 | Component Part# OS138 | Component Description 29X43X6 Right Side Crank Seal | List Price \$15.99 | OEM Part# 760304260 |
| | | | | | OS139 | 24X40X7 Left Side Crank Seal | \$15.99 | 760254070 |

KTM 125/144/150 SX

| Model | Year | Bore Size | Top End Kit | List Price | Component Part# | Component Description | List Price | OEM Part # |
|----------------|-------|-----------|--|------------------------------|---------------------------------------|--|------------------------------|---------------------------------|
| 125 SX, EXC | 98-01 | O-Ring | C7456 | \$31.91 | H0755043F | Head Gasket Outer | \$16.13 | 50330037000 |
| | | | | | R72X2V | Inner Head O-ring | \$3.57 | 0770720021 |
| | | | | | B0338018AFM | Base Gasket .018" | \$9.32 | 50330035040 |
| | | | | | B0338032AFM | Base Gasket .032" | \$9.32 | 50330035075 |
| | | | | | EC449032AFM | Exh. Intermediate Gasket 00-04 | \$6.02 | 50337046100 |
| | | | | | EC544032AFM | Exh. Intermediate Gasket 98-99 | \$6.02 | 50337046000 |
| | | | | | PV075032AFM | Rt. Side Power Valve Cover | \$2.44 | 50337006000 |
| | | | | | PV076032AFM | Center Power Valve Cover | \$2.44 | 50337035050 |
| | | | | | PV077032AFM | Left Side Power Valve Cove | \$2.44 | 50337008000 |
| | | | Bottom End Kit w/crank seals C3387 | List Price \$78.28 | Component Part# EC236060AFM | Component Description Outer Clutch Cover | List Price \$12.39 | OEM Part# 50330027000 |
| | | | | | EC441032AFM | Inner Clutch Cover | \$16.13 | 50330025000 |
| | | | | | EC442060AFM | Mag Cover | \$13.52 | 50330040000 |
| | | | | | EC443012F | Clutch Release Gasket .012" | \$2.56 | 50332065050 |
| | | | | | EC443032AFM | Clutch Release Gasket .032" | \$2.56 | 50332065050 |
| | | | | | EC443060AFM | Clutch Release Gasket .060" | \$2.56 | 50332065050 |
| | | | | | EC446020F | Center Case Gasket | \$16.13 | 50330039000 |
| | | | Crank Seal Kit C7661 | List Price \$28.81 | Component Part# OS136 | Component Description Right Crank Seal 24X35X7 | List Price \$15.99 | OEM Part# 760253570 |
| | | | | | OS141 | Left Crank Seal 31X45X6 | \$15.99 | 760324564 |



MX/Dirt · Off-Road · ATV Gaskets



Cometic Gasket - An Exclusive NASCAR Performance® Product

KTM 125/144/150 SX

| Model | Year | Bore Size | Top End Kit | List Price | Component Part# | Component Description | List Price | OEM Part # |
|-----------|-------|-----------|-------------------------------------|-------------------|------------------------|--|-------------------|---------------------------|
| 125 SX | 97-06 | O-Ring | C7386 | \$38.33 | R0047 | Outer Head O-ring | \$13.94 | 50330137000 |
| 125 EXC | 97-05 | | | | R62X2V | Inner Head O-ring | \$4.64 | 0770062020 |
| | | | | | WA130 | Head Seal Crush Washers 6 Req. | \$1.36 | 50230032010 |
| | | | | | B0338018AFM | Base Gasket .018" | \$9.32 | 50330035025 |
| | | | | | B0338032AFM | Base Gasket .032" | \$9.32 | 50330035040 |
| | | | | | PV075032AFM | Left Side Power Valve Gasket | \$2.44 | 50337008000 |
| | | | | | PV076032AFM | Right Side Power Valve Gasket | \$2.44 | 50337006000 |
| | | | | | PV077032AFM | Power Valve Cover Gasket | \$2.44 | 50337035050 |
| | | | | | EC449032AFM | Intermediate Exhaust Gasket | \$6.02 | 50337046100 |
| | | | | | R8X2V | Power Valve Axle O-ring | \$1.13 | 0770008020 |
| | | | | | R44X3S | Exp. Chamber O-rings 2 Req. | \$2.82 | 0770440030 |
| | | | Bottom End Kit w/crank seals | List Price | Component Part# | Component Part# | List Price | OEM Part# |
| | | | C3388 | \$92.90 | EC236060AFM | Outer Clutch Cover | \$12.39 | 50330027000 |
| | | | | | EC441032AFM | Inner Clutch Cover | \$16.13 | 50330025000 |
| | | | | | EC442060AFM | Mag Cover | \$13.52 | 50330040000 |
| | | | | | EC443032AFM | Clutch Release Gasket | \$2.56 | 50332065050 |
| | | | | | EC446020F | Center Case Gasket | \$16.13 | 50330039000 |
| | | | | | R16X3V | Water Pump O-ring/ Trans Fill Plug O-ring | \$1.26 | 0770160030 |
| | | | | | R23X2V | Transmission Counter Shaft O-ring | \$4.09 | 0770230020 |
| | | | | | R25X2V | Crank O-ring | \$3.21 | 0770250020 |
| | | | | | R49X2.5V | Water Pump O-ring | \$3.14 | 0770049025 |
| | | | Clutch & Mag Kit | List Price | Component Part# | Component Description | List Price | OEM Part # |
| | | | C7386CM | \$25.91 | EC236060AFM | Outer Clutch Cover | \$12.39 | 50330027000 |
| | | | | | EC442060AFM | Mag Cover | \$13.52 | 50330040000 |
| | | | Crank Seal Kit | List Price | Component Part# | Component Part# | List Price | OEM Part# |
| | | | C7661 | \$28.81 | OS136 | Right Crank Seal 24X35X7 | \$15.99 | 760253570 |
| | | | | | OS141 | Left Crank Seal 31X45X6 | \$15.99 | 760324564 |
| 125 SX | 07-14 | O-Ring | Top End Kit | List Price | Component Part# | Component Part# | List Price | OEM Part# |
| 144 SX | 07-08 | | C3211 | \$42.13 | R62X2V | Inner Head O-ring | \$4.64 | 0770062020 |
| 150 SX,XC | 09-14 | | | | R85X2V | Outer Head O-ring | \$7.14 | 0770086020 |
| | | | | | WA146 | Head Seal Crush Washer 6 Req. | \$2.16 | 50330079000 |
| | | | | | B0338018AFM | Base Gasket .018" | \$9.32 | 50330035025 |
| | | | | | EX645032AFM | Intermediate Exhaust Gasket | \$6.02 | 50337046200 |
| | | | | | R44X3S | Exp. Chamber O-rings 2 Req. | \$2.82 | 0770440030 |
| | | | | | PV076032AFM | Left Side Power Valve Gasket | \$2.44 | 50337006000 |
| | | | | | PV077032AFM | Power Valve Cover Gasket | \$2.44 | 50337035050 |
| | | | | | PV135032AFM | Right Side Power Valve Gasket | \$2.44 | 50337008100 |
| | | | | | R014V | Head Power Valve O-ring | \$1.08 | 0770012021 |
| | | | | | R16X3V | Power Valve Bushing O-ring Seal | \$1.26 | 0770160030 |
| | | | | | R8X2V | Power Valve Axle O-ring | \$1.13 | 0770008020 |
| | | | | | WA131 | Power Valve Control Shaft Seal | \$2.31 | 0603262322 |
| | | | | | WA133 | Power Valve Cover Crush Washer 3 Req. | \$0.90 | 0603061001 |
| | | | Bottom End Kit | List Price | Component Part# | Component Part# | List Price | OEM Part# |
| | | | C3518 | \$59.40 | EC236060AFM | Outer Clutch Cover | \$12.39 | 50330027000 |
| | | | | | WA129 | Water Pump Seal Washer 2 Req. | \$0.90 | 0603100141 |
| | | | | | WA133 | Head Crush Washer -6X10X1 | \$0.90 | 0603061001 |
| | | | | | R16X3V | Water Pump O-ring/ Trans Fill Plug O-ring | \$1.26 | 0770160030 |
| | | | | | R19X3V | Fill plug O-ring 19x3 | \$3.02 | 0770191015 |
| | | | | | EC441032AFM | Inner Clutch Cover | \$16.13 | 50330025000 |
| | | | | | EC446020F | Center Case Gasket | \$16.13 | 50330039000 |
| | | | | | WA137 | Oil Drain Plug Seal 12x18x1.5 2 Req. | \$1.53 | 58038022000 |
| | | | | | R24X2V | Transmission Counter Shaft O-ring | \$6.19 | 0770250020 |
| | | | | | EC443032AFM | Clutch Release Gasket | \$2.56 | 50332065050 |
| | | | | | R23X2V | Transmission Counter Shaft O-ring | \$4.09 | 0770230020/ 0770049025 |
| | | | Clutch & Mag Kit | List Price | Component Part# | Component Description | List Price | OEM Part # |
| | | | C7368CM | \$25.91 | EC236060AFM | Outer Clutch Cover | \$12.39 | 50330027000 |
| | | | | | EC442060AFM | Mag Cover | \$13.52 | 50330040000 |



MX/Dirt • Off-Road • ATV Gaskets



Cometic Gasket - An Exclusive NASCAR Performance® Product

KTM 200 SX

| Model | Year | Bore Size | Top End Kit | List Price | Component Part# | Component Description | List Price | OEM Part # | | |
|-----------------------------|-------------------|------------------------|------------------------------|-------------------|---|-------------------------------------|------------------------|------------------------------|-------------------|-------------------|
| 200 SX, MXC, EXC | 98-02 | O-Ring | C7738 | \$36.86 | R72X2V | Inner Head O-ring | \$3.57 | 0770720021 | | |
| | | | | | H0985043F | Outer Head Gasket | \$14.25 | 52330037000 | | |
| | | | | | B0338018AFM | Base Gasket .018" | \$9.32 | 50330035040 | | |
| | | | | | B0338032AFM | Base Gasket .032" | \$9.32 | 50330035040 | | |
| | | | | | EC450032AFM | Intermediate Gasket 98-99 | \$6.02 | 52337046000 | | |
| | | | | | EC545032AFM | Intermediate Gasket 00-01 | \$6.02 | 52337046100 | | |
| | | | | | PV075032AFM | Right Side Power Valve Gasket | \$2.44 | 50337008000 | | |
| | | | | | PV076032AFM | Left Side Power Valve Gasket | \$2.44 | 50337006000 | | |
| | | | | | PV077032AFM | Power Valve Cover Gasket | \$2.44 | 50337035050 | | |
| | | | | | Bottom End Kit w/crank seals | List Price | Component Part# | Component Description | List Price | OEM Part # |
| | | | | | C3389 | \$75.95 | EC236060AFM | Outer Clutch Cover | \$12.39 | 50330027000 |
| | | | | | | | EC441032AFM | Inner Clutch Cover | \$16.13 | 50330025000 |
| | | | | | | | EC442060AFM | Mag Cover | \$13.52 | 50330040000 |
| | | | | | | | EC443012F | Clutch Release Gasket | \$2.56 | 50332065050 |
| | | | | | | | EC443032AFM | Clutch Release Gasket .032" | \$2.56 | 50332065050 |
| | | EC443060AFM | Clutch Release Gasket .060" | \$2.56 | 50332065050 | | | | | |
| | | EC446020F | Center Case Gasket | \$16.13 | 50330039000 | | | | | |
| Clutch & Mag Kit | List Price | Component Part# | Component Description | List Price | OEM Part # | | | | | |
| C7368CM | \$25.91 | EC236060AFM | Outer Clutch Cover | \$12.39 | 50330027000 | | | | | |
| | | EC442060AFM | Mag Cover | \$13.52 | 50330040000 | | | | | |
| Crank Seal Kit | List Price | Component Part# | Component Part# | List Price | OEM Part# | | | | | |
| C7661 | \$28.81 | OS136 | Right Crank Seal 24X35X7 | \$15.99 | 760253570 | | | | | |
| | | OS141 | Left Crank Seal 31X45X6 | \$15.99 | 760324564 | | | | | |
| 200 SX, EXC, MXC XC-W | 03-14 | O-Ring | C7942 | \$38.33 | R0048 | Outer Head O-ring | \$13.94 | 52330137000 | | |
| | | | | | R72X2V | Inner Head O-ring | \$3.57 | 0770720021 | | |
| | | | | | B0338018AFM | Base Gasket .018" | \$9.32 | 50330035040 | | |
| | | | | | B0338032AFM | Base Gasket .032" | \$9.32 | 50330035040 | | |
| | | | | | R44X3S | Expansion Chamber O-rings 2 Req. | \$2.82 | 0770440030 | | |
| | | | | | EC545032AFM | Intermediate Gasket | \$6.02 | 52337046100 | | |
| | | | | | PV075032AFM | Right Side Power Valve Gasket | \$2.44 | 50337008000 | | |
| | | | | | PV076032AFM | Left Side Power Valve Gasket | \$2.44 | 50337006000 | | |
| | | | | | PV077032AFM | Power Valve Cover Gasket | \$2.44 | 50337035050 | | |
| | | | | | WA131 | Power Valve Control Shaft Seal | \$2.31 | 0603262322 | | |
| | | | | | WA133 | Head Crush Washer -6X10X1 3 Req. | \$0.90 | 0603061001 | | |
| | | | | | R8X2V | Power Valve Axle O-ring 2 Req. | \$1.13 | 0770008020 | | |
| | | | | | Bottom End Kit w/crank seals | List Price | Component Part# | Component Description | List Price | OEM Part # |
| | | | | | C3389 | \$78.99 | EC236060AFM | Outer Clutch Cover | \$12.39 | 50330027000 |
| | | | | | | | EC441032AFM | Inner Clutch Cover | \$16.13 | 50330025000 |
| | | | | | | | EC442060AFM | Mag Cover | \$13.52 | 50330040000 |
| | | | | | | | EC443012F | Clutch Release Gasket | \$2.56 | 50332065050 |
| | | | | | | | EC443032AFM | Clutch Release Gasket .032" | \$2.56 | 50332065050 |
| | | | | | | | EC443060AFM | Clutch Release Gasket .060" | \$2.56 | 50332065050 |
| | | | | | | | EC446020F | Center Case Gasket | \$16.13 | 50330039000 |
| | | | | | Clutch & Mag Kit | List Price | Component Part# | Component Description | List Price | OEM Part # |
| | | | | | C7368CM | \$25.91 | EC236060AFM | Outer Clutch Cover | \$12.39 | 50330027000 |
| | | | | | | | EC442060AFM | Mag Cover | \$13.52 | 50330040000 |
| | | | | | Crank Seal Kit | List Price | Component Part# | Component Part# | List Price | OEM Part# |
| | | | | | C7661 | \$28.81 | OS136 | Right Crank Seal 24X35X7 | \$15.99 | 760253570 |
| | | OS141 | Left Crank Seal 31X45X6 | \$15.99 | 760324564 | | | | | |



MX/Dirt · Off-Road · ATV Gaskets



Cometic Gasket - An Exclusive NASCAR Performance® Product

250 SX

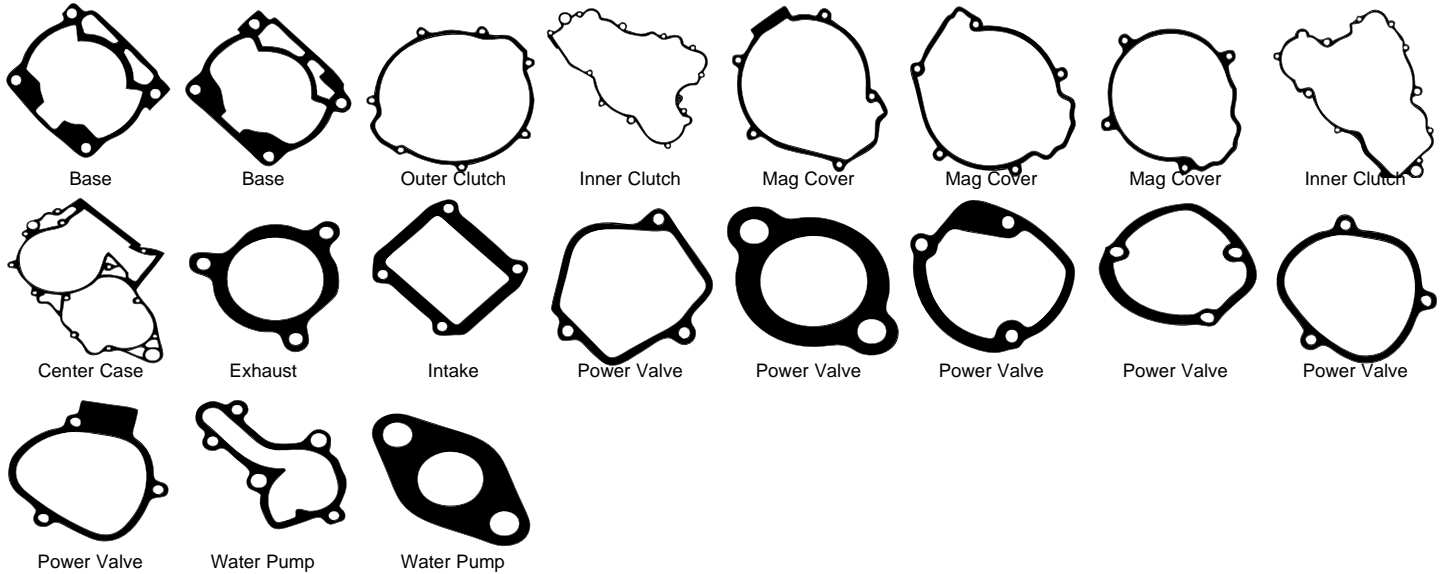

| Model | Year | Bore Size | Top End Kit | List Price | Component Part# | Component Description | List Price | OEM Part # | | | | |
|-------------------|-----------------------------|-------------------|------------------------|------------------------------|-------------------|-------------------------------------|-------------------|------------------------|-----------------------------------|------------------------------|-------------------|------------------|
| 250 SX, EXC | 90-99 | O-Ring | C7098 | \$38.33 | R114X2B | Outer Head O-ring | \$4.00 | 0770114020 | | | | |
| | | | | | R74X2S | Inner Head O-ring | \$3.57 | 0770740021 | | | | |
| | | | | | B0056018AFM | Base Gasket .018" | \$9.32 | 54630030005 | | | | |
| | | | | | B0056032AFM | Base Gasket .032" | \$6.25 | 54630030107 | | | | |
| | | | | | EX014047F | Exhaust Flange Gasket | \$4.65 | 54630046000 | | | | |
| | | | | | PV028018AFM | Power Valve Timer Gasket | \$3.80 | 54637006100 | | | | |
| | | | | | PV049018AFM | Left Side Power Valve Gasket | \$3.80 | 54637106000 | | | | |
| | | | | | PV088032AFM | Right Side Power Valve Gasket | \$2.33 | 54637073000 | | | | |
| | | | | | | Bottom End Kit w/crank seals | List Price | | Component Part# | Component Description | List Price | OEM Part# |
| | | | | | | C3390 | \$80.26 | EC234060AFM | Outer Clutch Cover Gasket | \$12.39 | 54630025050 | |
| | | | | | | | | EC285032AFM | Inner Clutch Cover | \$14.87 | 54630025200 | |
| | | | | | | | | EC286020F | Center Case Gasket | \$20.22 | 54630039200 | |
| | | | | | | | | EC287060AFM | Mag Cover Gasket | \$10.68 | 54630040300 | |
| | | | | | | | | R24X2V | Transmission Counter Shaft O-ring | \$6.19 | 0770250020 | |
| | | | | | | | | WP008032AFM | Water Pump Gasket | \$3.80 | 54635003200 | |
| | | | WP081032AFM | Power Valve Spring Cover | \$2.33 | 54435037000 | | | | | | |
| | Crank Seal Kit | List Price | Component Part# | Component Description | List Price | OEM Part# | | | | | | |
| | C7662 | \$28.81 | OS136 | Right Crank Seal 24X35X7 | \$15.99 | 760253570 | | | | | | |
| | | | OS137 | Left Crank Seal 37X53X7 | \$15.99 | 760385273 | | | | | | |
| 250 SX 250 EXC | 00-02 00-03 | O-Ring | C7690 | \$42.13 | R114X2B | Outer Head O-ring | \$4.00 | 0770114020 | | | | |
| | | | | | R74X2S | Inner Head O-ring | \$3.57 | 0770720021 | | | | |
| | | | | | B0056018AFM | Base Gasket .018" | \$9.32 | 54630030005 | | | | |
| | | | | | B0056032AFM | Base Gasket .032" | \$6.25 | 54630030107 | | | | |
| | | | | | R44X3S | Expansion Chamber O-ring | \$2.82 | 0770440030 | | | | |
| | | | | | EX014042AM | Exhaust Flange Gasket | \$4.65 | 54630046000 | | | | |
| | | | | | PV103032AFM | Left Side Power Valve Gasket | \$3.80 | 54737006000 | | | | |
| | | | | | PV104032AFM | Right Side Power Valve Gasket | \$3.80 | 54737008000 | | | | |
| | | | | | | Bottom End Kit w/crank seals | List Price | Component Part# | Component Description | List Price | OEM Part# | |
| | | | | | | C3391 | \$75.99 | EC234060AFM | Outer Clutch Cover Gasket | \$12.39 | 54630025050 | |
| | | | | | | | | EC285032AFM | Inner Clutch Cover | \$14.87 | 54630025200 | |
| | | | | | | | | EC286020F | Case Gasket | \$20.22 | 54630039200 | |
| | | | | | | | | EC549060AFM | Mag Cover Gasket | \$11.75 | 54730040100 | |
| | | | | | | | | WP008032AFM | Water Pump Gasket | \$3.80 | 54635003200 | |
| | | | | | | Crank Seal Kit | List Price | Component Part# | Component Description | List Price | OEM Part# | |
| | C7662 | \$28.81 | OS136 | Right Crank Seal 24X35X7 | \$15.99 | 760253570 | | | | | | |
| | | | OS137 | Left Crank Seal 37X53X7 | \$15.99 | 760385273 | | | | | | |
| | Clutch & Mag Kit | List Price | Component Part# | Component Description | List Price | OEM Part # | | | | | | |
| | C7690CM | \$24.14 | EC234060AFM | Clutch Cover Gasket | \$12.39 | 54630025050 | | | | | | |
| | | | EC549060AFM | Mag Cover Gasket | \$11.75 | 54730040100 | | | | | | |

All Component Parts can be purchased individually.



MX/Dirt · Off-Road · ATV Gaskets



Cometic Gasket - An Exclusive NASCAR Performance® Product

KTM

| Model | Year | Bore Size | Top End Kit | List Price | Component Part# | Component Description | List Price | OEM Part # | | | |
|------------------|----------------|-----------|-------------------------------------|------------------------------------|-------------------------------------|--|------------------------------|------------------------|------------------------|-------------------|------------------|
| 250 SX | 03-06 | O-Ring | C7943 | \$45.99 | R114X2B | Outer Head O-ring | \$4.00 | 0770114020 | | | |
| | | | | | R74X2S | Inner Head O-ring | \$3.57 | 0770720021 | | | |
| | | | | | B0666018AFM | Base Gasket .018" | \$6.25 | 54830030004 | | | |
| | | | | | B0666032AFM | Base Gasket .032" | \$6.25 | 54830030004 | | | |
| | | | | | IR386018AFM | Intake Gasket | \$4.37 | 548030062000 | | | |
| | | | | | R44X3S | Expansion Chamber O-rings 2 Req. | \$2.82 | 0770440030 | | | |
| | | | | | PV103032AFM | Left Side Power Valve Gasket | \$3.80 | 54737006000 | | | |
| | | | | | PV104032AFM | Right Side Power Valve Gasket | \$3.80 | 54737008000 | | | |
| | | | | | Bottom End Kit w/crank seals | | List Price | Component Part# | Component Part# | List Price | OEM Part# |
| | | | | | C3392 | \$88.35 | EC777032AFM | Mag Cover Gasket | \$11.75 | 54830040000 | |
| | | | | | EC778032AFM | Inner Clutch Cover Gasket | \$14.87 | 54830024000 | | | |
| | | | | | EC779020F | Center Case Gasket | \$23.80 | 54830039000 | | | |
| | | | | | R0049 | Outer Clutch Cover Gasket | \$15.72 | 54830025000 | | | |
| | | | | | R0050 | Molded Water Pump Gasket | \$11.30 | 54835003000 | | | |
| | | | Clutch & Mag Kit C7943CM | | List Price | Component Part# | Component Description | List Price | OEM Part # | | |
| | | | | \$27.47 | EC234060AFM | Clutch Cover Gasket | \$12.39 | 54630025050 | | | |
| | | | | | EC777032AFM | Mag Cover Gasket | \$11.75 | 54830040000 | | | |
| | | | Crank Seal Kit C7662 | | List Price | Component Part# | Component Part# | List Price | OEM Part# | | |
| | | | | \$28.81 | EC778032AFM | Inner Clutch Cover Gasket | \$14.87 | 54830024000 | | | |
| | | | | | OS137 | OS137 Lt. Crank Seal 37x53x7 | \$15.99 | 760385273 | | | |
| 250 SX 250 XC | 07-16 07-16 | O-Ring | C3222 | \$38.33 | R73X2V | Inner Head O-ring 250 Models | \$3.71 | 0770730020 | | | |
| | | | | | R78X2V | 2008 300 XC Models | \$4.29 | 0770078020 | | | |
| | | | | | WA135 | Head Seal O-rings | \$0.80 | 56530080000 | | | |
| | | | | | R105X2B | Outer Head O-ring | \$2.57 | 0770105020 | | | |
| | | | | | B0666018AFM | Base Gasket .018" | \$6.25 | 54830030004 | | | |
| | | | | | R44X3S | Exhaust Flange O-rings | \$2.82 | 0770440030 | | | |
| | | | | | PV136032AFM | Left Side Power Valve Gasket | \$4.72 | 54837006000 | | | |
| | | | | | PV137032AFM | Right Side Power Valve Gasket | \$5.00 | 54837008000 | | | |
| | | | | | R112V | Power Valve Flap O-rings | \$1.19 | 0770116241 | | | |
| | | | | | R114V | Power Valve Spring Guide O-ring | \$1.19 | 0770021120 | | | |
| | | | R16X2V | Power Valve Control O-rings 2 Req. | \$3.02 | 0770160021 | | | | | |
| | | | R24X2V | Power Valve Control Cover O-ring | \$6.19 | 0770240020 | | | | | |
| | | | Bottom End Kit C3539 | | List Price | Component Part# | Component Part# | List Price | OEM Part# | | |
| | | | | \$101.61 | EC779020F | Intake Gasket | \$4.09 | 54830062200 | | | |
| | | | | | EC778032AFM | Center Case Gasket | \$23.80 | 54830039000 | | | |
| | | | | | R19X3V | Clutch Cover Gasket | \$14.87 | 54830024000 | | | |
| | | | | | | Clutch Fill Plug O-ring 19,00x3,00 NBR | \$3.02 | 0770191015 | | | |
| | | | | | R0049 | Outer Clutch Cover O-ring | \$15.72 | 54830025000 | | | |
| | | | | | WA137 | Drain Plug Washer 12x18x1,5 | \$1.53 | 58038022000 | | | |
| | | | | | R0050 | Water Pump Cover O-ring MR | \$11.30 | 54835003000 | | | |
| | | | | | WA129 | Water Pump Drain Crush Washer 10x14x1 | \$0.95 | 0603100141 | | | |
| | | | | | R25X1.5V | Crank O-ring 25x1.5 | \$6.19 | 0770250015 | | | |
| | | | | | WA129 | Copper Crush Gasket Clutch Line 2 Req. 10X14X1 | \$0.95 | 0603100141 | | | |
| | | | | | R30X1.5V | Slave Cylinder O-Ring | \$2.29 | 0770300015 | | | |
| | | | | | R25X2V | Output Shaft O-ring 25,00X2,00 | \$3.21 | 0770250020 | | | |
| | | | | | R027V | Thermostat O-ring 32x2 | \$3.57 | 0770320020 | | | |
| | | | | | EC1254032AFM | Ignition Cover Gasket | \$9.79 | 55130040000 | | | |
| | | | | | EC1927018AFM | Outer Ignition Cover (Estart) | \$6.74 | 55130041100 | | | |
| | | | | | R25X3V | Estart O-ring 25,00X3,00 | \$2.90 | 0770250030 | | | |
| | | | Clutch & Mag Kit C7943CM | | List Price | Component Part# | Component Description | List Price | OEM Part # | | |
| | | | | \$27.47 | EC234060AFM | Clutch Cover Gasket | \$12.39 | 54630025050 | | | |
| | | | | | EC777032AFM | Mag Cover Gasket | \$11.75 | 54830040000 | | | |



MX/Dirt · Off-Road · ATV Gaskets



Cometic Gasket - An Exclusive NASCAR Performance® Product

250 EXC

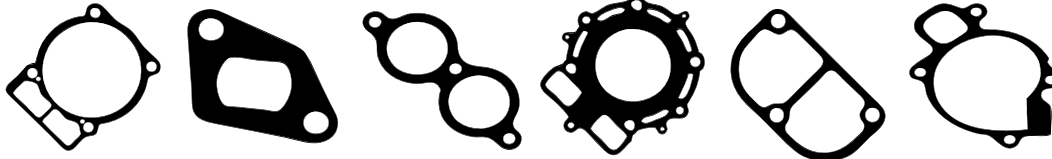

| Base | | Cam Chain Tensioner | Exhaust | Head | Valve Cover | Water Pump | | |
|----------|-------|---------------------|---|-------------------|------------------------|--|-------------------|------------------|
| Model | Year | Bore Size | Top End Kit | List Price | Component Part# | Component Description | List Price | OEM Part # |
| 250 EXC | 04 | O-Ring | C7417 | \$46.33 | R74X2S | Inner Head O-ring 2004 | \$3.57 | 0770740021 |
| 250 XC | 04-06 | | | | R76X2V | Inner Head O-ring 2005 | \$3.64 | 0770760021 |
| | | | | | WA135 | Head Seal Crush Washer 6 Req. | \$0.80 | 56530080000 |
| | | | | | R114X2B | Outer Head O-ring | \$4.00 | 0770114020 |
| | | | | | B0666018AFM | Base Gasket .018" | \$6.25 | 54830030004 |
| | | | | | B0666032AFM | Base Gasket .032" | \$6.25 | 54830030004 |
| | | | | | IR386018AFM | Intake Gasket | \$4.37 | 548030062000 |
| | | | | | R44X3S | Expansion Chamber O-rings 2 Req. | \$2.82 | 0770440030 |
| | | | | | R15X1.5V | Power Valve Control O-ring | \$1.13 | 077015051 |
| | | | | | R11.5X2.5V | Power Valve Cover O-rings 4 Req. | \$0.94 | 0770116241 |
| | | | | | PV103032AFM | Left Side Power Valve Gasket | \$3.80 | 54737006000 |
| | | | | | PV104032AFM | Right Side Power Valve Gasket | \$3.80 | 54737008000 |
| | | | Bottom End Kit w/o crank seals | List Price | Component Part# | Description | List Price | OEM Part# |
| | | | C3393 | \$92.71 | EC777032AFM | Mag Cover Gasket | \$11.75 | 54830040000 |
| | | | | | EC778032AFM | Inner Clutch Cover Gasket | \$14.87 | 54830024000 |
| | | | | | EC779020F | Center Case Gasket | \$23.80 | 54830039000 |
| | | | | | R0049 | Outer Clutch Cover Gasket | \$15.72 | 54830025000 |
| | | | | | R0050 | Molded Water Pump Gasket | \$11.30 | 54835003000 |
| | | | | | R12.5X2.5V | Water Pump O-ring | \$4.09 | 0770021120 |
| | | | | | R19X3V | Clutch Fill Plug O-ring/ Case Seal O-ring | \$3.02 | 0770191015 |
| | | | | | R24X2V | Water Pump O-ring | \$6.19 | 0770240020 |
| | | | | | R25X1.5V | Crank O-ring | \$6.19 | 0770250015 |
| | | | | | R25X2V | Countershaft O-ring | \$3.21 | 0770250020 |
| | | | | | R30X1.5V | Clutch Push Rod O-ring | \$2.29 | 0770300015 |
| | | | | | WA133 | Water Pump Seal Washer | \$0.90 | 0603100141 |
| 250 EXC, | 02-05 | 76 mm | Top End Kit | List Price | Component Part# | Description | List Price | OEM Part# |
| RFS | | 78 mm | C7169 | \$58.76 | H1925040S | Head Gasket | \$25.95 | 59830036000 |
| | | | C7409 | \$58.76 | H2099040S | Head Gasket 78mm Bore | \$25.95 | |
| | | | | | B0480020F | Base Gasket | \$4.32 | 59030035050 |
| | | | | | EX281042AM | Exhaust Gasket | \$12.44 | 59036041000 |
| | | | | | EC495018AFM | Cam Chain Tensioner | \$3.80 | 59036003050 |
| | | | | | VC027031F | Valve Cover Gasket | \$1.19 | 58036053000 |
| | | | | | R017B | Oil Screen Plug O-rings | \$1.14 | 0770020170 |
| | | | | | R12.5X2V | Oil Screen O-rings 2 Req. | \$3.74 | 0770125015 |
| | | | | | R40X2.5B | Oil Filter O-rings 2 Req. | \$3.74 | 0770400025 |
| | | | | | WA005063C | Oil Line Washers 4 Req. | \$0.57 | 0603082121 |
| | | | | | WP114018AFM | Water Pump Gasket | \$1.71 | 59035053000 |



MX/Dirt · Off-Road · ATV Gaskets



Cometic Gasket - An Exclusive NASCAR Performance® Product

KTM 250 SX-F

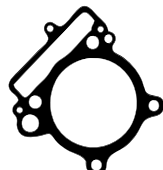

Base



Exhaust

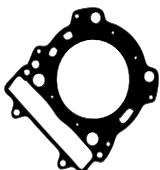

Head

| Model | Year | Bore Size | Top End Kit | List Price | Component Part# | Component Description | List Price | OEM Part # |
|-----------------|-------|-----------|---|-------------------|------------------------|------------------------------|-------------------|-------------------|
| 250 SX-F, | 05-12 | 77 mm | C3164-EST | \$60.84 | H2408027S | Head Gasket 77mm Bore | \$33.23 | 77030036000 |
| EXC-F, XC-F | | 79 mm | C3184-EST | \$60.84 | H2408SP5027S | Head Gasket 79mm Bore | \$33.23 | 77030036000 |
| | | | | | B0748010RC | Base Gasket | \$9.94 | 77030035000 |
| | | | | | EX702064AM | Exhaust Gasket | \$8.68 | 77036041000 |
| | | | | | R018B | Cam Chain Tensioner O-ring | \$3.92 | 0770180020 |
| | | | | | WA145 | Cam Chain Tensioner Seal | \$2.16 | 0603242920 |
| | | | | | WA146 | Cam Chain Guide Bolt Seal | \$2.16 | 0603082121 |
| | | | | | 3186V | Valve Seals 4 Req. | \$4.99 ea. | 77036027000 |
| | | | | | R012SB | Plug Seal O-Ring | \$0.96 | 0770080020 |
| | | | Bottom End Kit w/o crank seals | List Price | Component Part# | Description | List Price | OEM Part# |
| | | | C3502 | \$47.35 | EC1035032AFM | Mag Cover Gasket | \$6.30 | 77030040000 |
| | | | | | R40X2.5B | Oil filter O-Ring | \$3.74 | 0770400025 |
| | | | | | R12.5X2V | Oil Screen O-rings 2 Req. | \$3.74 | 0770125015 |
| | | | | | R017B | Oil Screen Plug O-ring | \$1.14 | 0770020170 |
| | | | | | WP427 | Water Pump Cover Gasket | \$6.19 | 77035053000 |
| | | | | | WA133 | Water Pump Crush Seal | \$0.90 | 0603061001 |
| | | | | | R30X1.5V | Slave Cylinder O-Ring | \$2.29 | 0770300015 |
| | | | | | EC1360018AFM | Slave Cylinder Gasket | \$4.37 | 59032065000 |
| | | | | | WA129 | Clutch Bleeder Seal | \$0.95 | 42013226000 |
| | | | | | EC1036032AFM | Inner Clutch Cover Gasket | \$17.38 | 77030025100 |
| | | | | | WA137 | Oil Drain Plug Seal 2 Req. | \$1.53 | 58038022000 |
| | | | | | R12X2V | Oil Relief O-Ring | \$4.09 | 0770120020 |
| 250 SX-F, 13-14 | | 78mm | Top End Kit | List Price | Component Part# | Component Description | List Price | OEM Part # |
| EXC-F, | | | C3511-EST | \$71.75 | R023V | Plug Well O-ring 2 Req. | \$1.46 | 0770260015 |
| XC-F | | | C3516-EST | \$71.75 | R9X1.5V | Cam End Plug O-ring 2 Req. | \$2.56 | 07700900151 |
| | | | | | H3698SP2027S | 81mm Cylinder Head Gasket | \$33.23 | 77730036085 |
| | | | | | WA145 | Cam Chain Tensioner Gasket | \$2.16 | 0603242920 |
| | | | | | R018B | Cam Chain O-Ring | \$3.92 | 0770180020 |
| | | | | | R013V | Cam Chain O-Ring | \$1.08 | 0770010010 |
| | | | | | 3186V | Valve Seal 4 Req. | \$4.99 ea. | 77036027000 |
| | | | | | B1026010RC | Base Gasket | \$11.87 | 77230035000 |
| | | | | | R10X2V | Temp Sensor O-ring | \$1.59 | 0770100020 |
| | | | | | EX1333059F | Exhaust Gasket | \$5.05 | 77236041000 |
| | | | | | H3698027S | Stock Cylinder Head Gasket | \$33.23 | 77730036085 |
| | | | | | R40X2V | Intake Cam Decomp. O-Ring | \$2.82 | 0770400010 |
| | | | Bottom End Kit | List Price | Component Part# | Component Description | List Price | OEM Part# |
| | | | C3513 | \$52.59 | EC1455032AFM | Mag Cover Gasket | \$6.30 | 77530040000 |
| | | | | | WA137 | Magnet Plug Crush Washer | \$1.53 | 58038022000 |
| | | | | | R022V | Output Shaft O-Ring | \$1.19 | 0770020220 |
| | | | | | WA129 | Clutch Line Crush Washers | \$0.95 | 42013226000 |
| | | | | | EC1742018AFM | Starter Cover Gasket | \$1.71 | 77240043000 |
| | | | | | R014V | Drain Plug Gasket | \$1.08 | 0770110015 |
| | | | | | R014V | Drain Plug O-Ring 2 Req. | \$1.08 | 0770110015 |
| | | | | | R19X3V | Fill plug O-Ring | \$3.02 | 0770191015 |
| | | | | | R12.5X2V | Oil Screen O-Rings 2 Req. | \$3.74 | 0770125015 |
| | | | | | R031V | Oil Pump Cover O-Ring | \$4.65 | 0770440020 |
| | | | | | R028V | Oil Filter O-Ring | \$1.19 | 07703305178 |
| | | | | | R017V | Oil Screen Plug O-Ring | \$0.50 | 0770020170 |
| | | | | | EC1817018AFM | Clutch Slave Cylinder Gasket | \$4.37 | 77232062000 |
| | | | | | WP427 | Water Pump Cover Gasket | \$4.29 | 77235053000 |
| | | | | | EC1816032AFM | Inner Clutch Cover Gasket | \$17.38 | 77730025000 |
| | | | | | MR126 | Outer Clutch Cover O-ring | \$8.04 | 77230027000 |



MX/Dirt · Off-Road · ATV Gaskets



Cometic Gasket - An Exclusive NASCAR Performance® Product

KTM

| Model | Year | Bore Size | Top End Kit | List Price | Component Part# | Component Description | List Price | OEM Part # |
|------------------------------------|------|-----------|-------------|------------|-----------------|-----------------------------------|------------|-------------|
| 250 SX-F, 15-16 Factory Edition | | 79mm | C3595-EST | \$71.75 | H3698027S | Cylinder Head Gasket | \$33.23 | 79030036086 |
| | | | | | B1301014RC | Cylinder Base Gasket | \$17.59 | 79230035000 |
| | | | | | 3186V | Valve Stem Seals 4 Required | \$4.99 | 77036027000 |
| | | | | | R018B | Cam Chain Tensioner O-ring | \$3.92 | 770180020 |
| | | | | | WA145 | Cam Chain Tensioner Crush Seal | \$2.16 | 603242920 |
| | | | | | R013V | Cam Chain Tensioner Cap O-ring | \$1.08 | 770010010 |
| | | | | | R023V | Plug Well Cam Tower O-rings | \$1.46 | 770260015 |
| | | | | | EX1333059F | Exhaust Flange Gasket | \$5.05 | 77236041000 |

300 SX

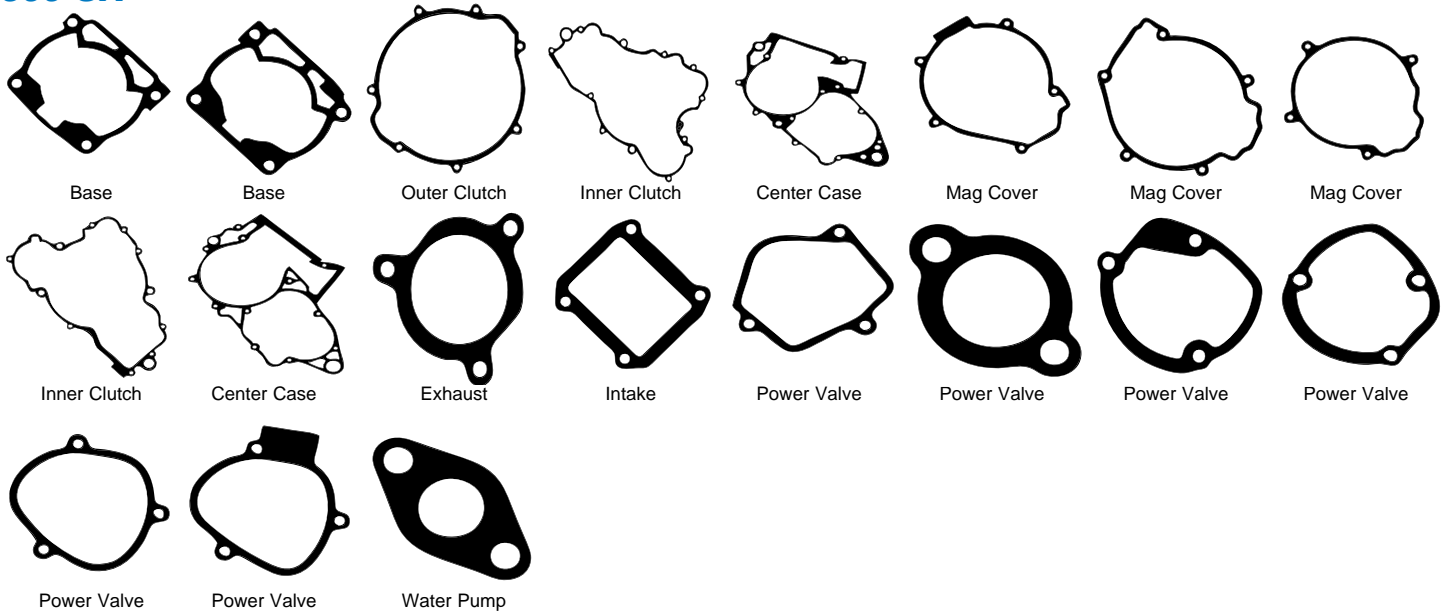

| Model | Year | Bore Size | Top End Kit | List Price | Component Part# | Component Description | List Price | OEM Part # | | | |
|----------------|-----------------------|-------------------|------------------------|---------------------------|-------------------|---|-------------------|------------------------|--------------------------|-------------------|------------------|
| 300 SX, EXC | 90-99 | O-Ring | C7099 | \$38.33 | R78X2V | Inner Head O-ring 300 XC Models | \$4.29 | 0770078020 | | | |
| | | | | | R114X2B | Outer Head O-ring | \$4.00 | 0770114020 | | | |
| | | | | | B0056018AFM | Base Gasket .018" | \$9.32 | 54630030005 | | | |
| | | | | | B0056032AFM | Base Gasket .032" | \$6.25 | 54630030107 | | | |
| | | | | | EX014047F | Exhaust Flange Gasket | \$4.65 | 54630046000 | | | |
| | | | | | PV028018AFM | Right Side Power Valve | \$3.80 | 54637006100 | | | |
| | | | | | PV049018AFM | Left Side Power Valve | \$3.80 | 54637106000 | | | |
| | | | | | PV088032AFM | Rt. Side Power Valve 90-99 | \$2.33 | 54637073000 | | | |
| | | | | | | Bottom End Kit w/crank seals | List Price | Component Part# | Component Part# | List Price | OEM Part# |
| | | | | | | C3390 | \$80.26 | WP081032AFM | Power Valve Spring Cover | \$2.33 | 54435037000 |
| | | | EC234060AFM | Outer Clutch Cover Gasket | \$12.39 | 54630025050 | | | | | |
| | | | EC285032AFM | Inner Clutch Cover Gasket | \$14.87 | 54630025200 | | | | | |
| | | | EC286020F | Center Case Gasket | \$20.22 | 54630039200 | | | | | |
| | | | EC287060AFM | Mag Cover Gasket | \$10.68 | 54630040300 | | | | | |
| | | | R24X2V | Water Pump O-ring | \$6.19 | 0770240020 | | | | | |
| | Crank Seal Kit | List Price | Component Part# | Component Part# | List Price | OEM Part# | | | | | |
| | C7662 | \$28.81 | OS136 | Right Crank Seal 24X35X7 | \$15.99 | 760253570 | | | | | |
| | | | OS137 | Left Crank Seal 37X53X7 | \$15.99 | 760385273 | | | | | |



MX/Dirt • Off-Road • ATV Gaskets



Cometic Gasket - An Exclusive NASCAR Performance® Product

KTM

| Model | Year | Bore Size | Top End Kit | List Price | Component Part# | Component Description | List Price | OEM Part # | | |
|------------------------------|-------------------|------------------------|------------------------------|-------------------|-------------------------------------|------------------------------------|------------------------|-----------------------------------|-------------------|-------------------|
| 300 SX, EXC, MXC | 00-03 | O-Ring | C7816 | \$38.33 | R78X2V | Inner Head O-ring 300 XC Models | \$4.29 | 0770078020 | | |
| | | | | | R114X2B | Outer Head O-ring | \$4.00 | 0770114020 | | |
| | | | | | B0056018AFM | Base Gasket .018" | \$9.32 | 54630030005 | | |
| | | | | | B0056032AFM | Base Gasket .032" | \$6.25 | 54630030107 | | |
| | | | | | EX014047F | Exhaust Flange Gasket | \$4.65 | 54630046000 | | |
| | | | | | R15X1.5V | Power Valve Control O-rings 2 Req. | \$1.13 | 0770 15051 | | |
| | | | | | R16X2V | Power Valve Control O-rings 2 Req. | \$3.02 | 0770160021 | | |
| | | | | | PV103032AFM | Left Side Power Valve Gasket | \$3.80 | 54737006000 | | |
| | | | | | PV104032AFM | Right Side Power Valve Gasket | \$3.80 | 54737008000 | | |
| | | | | | Bottom End Kit w/crank seals | List Price | Component Part# | Component Description | List Price | OEM Part# |
| | | | | | C3391 | \$75.99 | EC234060AFM | Outer Clutch Cover Gasket | \$12.39 | 54630025050 |
| | | | | | | | EC285032AFM | Inner Clutch Cover Gasket | \$14.87 | 54630025200 |
| | | | | | | | EC286020F | Center Case Gasket | \$20.22 | 54630039200 |
| | | | | | | | EC549060AFM | Mag Cover Gasket | \$11.75 | 54730040100 |
| | | | | | | | WP081032AFM | Power Valve Spring Cover | \$2.33 | 54435037000 |
| Clutch & Mag Kit | List Price | Component Part# | Component Description | List Price | OEM Part # | | | | | |
| C7690CM | \$24.14 | EC234060AFM | Clutch Cover Gasket | \$12.39 | 54630025050 | | | | | |
| | | EC549060AFM | Mag Cover Gasket | \$11.75 | 54730040100 | | | | | |
| Crank Seal Kit | List Price | Component Part# | Component Part# | List Price | OEM Part# | | | | | |
| C7662 | \$28.81 | OS136 | Right Crank Seal 24X35X7 | \$15.99 | 760253570 | | | | | |
| | | OS137 | Left Crank Seal 37X53X7 | \$15.99 | 760385273 | | | | | |
| 300 EXC, MXC, XC, XC-W | 04-07 | O-Ring | C7423 | \$46.33 | R80X2S | Inner Head O-ring | \$5.29 | 0770800021 | | |
| | | | | | R114X2B | Outer Head O-ring | \$4.00 | 0770114020 | | |
| | | | | | WA135 | Head Seal Crush Washer 6 Req. | \$0.80 | 56530080000 | | |
| | | | | | B0666018AFM | Base Gasket .018" | \$6.25 | 54830030004 | | |
| | | | | | B0666032AFM | Base Gasket .032" | \$6.01 | 54830030004 | | |
| | | | | | IR386018AFM | Intake Gasket | \$4.37 | 548030062000 | | |
| | | | | | R44X3S | Exp. Chamber O-rings 2 Req. | \$2.82 | 0770440030 | | |
| | | | | | PV103032AFM | Left Side Power Valve Gasket | \$3.80 | 54737006000 | | |
| | | | | | PV104032AFM | Right Side Power Valve Gasket | \$3.80 | 54737008000 | | |
| | | | | | R11.5X2.5V | Power Valve Cover O-rings 4 Req. | \$0.94 | 0770116241 | | |
| | | | | | R15X1.5V | Power Valve Control O-ring | \$1.13 | 077015051 | | |
| | | | | | Bottom End Kit w/crank seals | List Price | Component Part# | Component Part# | List Price | OEM Part# |
| | | | | | C3392 | \$88.35 | EC777032AFM | Mag Cover Gasket | \$11.75 | 54830040000 |
| | | | | | | | EC778032AFM | Inner Clutch Cover Gasket | \$14.87 | 54830024000 |
| | | | | | | | EC779020F | Center Case Gasket | \$23.80 | 54830039000 |
| | | | | | | | R0049 | Outer Clutch Cover Gasket | \$15.72 | 54830025000 |
| | | | | | | | R0050 | Molded Water Pump Gasket | \$11.30 | 54835003000 |
| | | | | | | | R12.5X2.5V | Water Pump O-ring | \$4.09 | 0770021120 |
| | | | | | | | R19X3V | Clutch Fill Plug/Case Seal O-ring | \$3.02 | 0770191015 |
| | | | | | | | R24X2V | Water Pump O-ring | \$6.19 | 0770240020 |
| | | | | | | | R25X1.5V | Crank O-ring | \$6.19 | 0770250015 |
| | | | | | | | R25X2V | Countershaft O-ring | \$3.21 | 0770250020 |
| | | | | | | | R30X1.5V | Clutch Push Rod O-ring | \$2.29 | 0770300015 |
| | | | | | | | WA133 | Water Pump Seal Washer | \$0.90 | 0603100141 |
| | | | | | Clutch & Mag Kit | List Price | Component Part# | Component Description | List Price | OEM Part # |
| | | | | | C7943CM | \$27.47 | R0049 | Clutch Cover Gasket | \$15.72 | 54830025000 |
| | | | | | | | EC777032AFM | Mag Cover Gasket | \$11.75 | 54830040000 |
| | | | | | Crank Seal Kit | List Price | Component Part# | Component Part# | List Price | OEM Part# |
| | | | | | C7662 | \$28.81 | OS136 | Right Crank Seal 24X35X7 | \$15.99 | 760253570 |
| | | | | | | | OS137 | Left Crank Seal 37X53X7 | \$15.99 | 760385273 |



MX/Dirt · Off-Road · ATV Gaskets



Cometic Gasket - An Exclusive NASCAR Performance® Product

KTM

| Model | Year | Bore Size | Top End Kit | List Price | Component Part# | Component Description | List Price | OEM Part # | | | | |
|-----------------|-------|-----------|-------------|------------|------------------------|---------------------------------|-------------------|-----------------------------|--|----------------------------------|--------|------------|
| 300 XC, XC-W | 08-10 | O-Ring | C3222 | \$38.33 | R73X2V | Inner Head O-ring 250 Models | \$3.71 | 0770730020 | | | | |
| | | | | | R78X2V | 2008 300 XC Models | \$4.29 | 0770078020 | | | | |
| | | | | | R105X2B | Outer Head O-ring | \$2.57 | 0770105020 | | | | |
| | | | | | WA135 | Head Seal O-rings | \$0.80 | 56530080000 | | | | |
| | | | | | B0666018AFM | Base Gasket .018" | \$6.25 | 54830030004 | | | | |
| | | | | | R44X3S | Exhaust Flange O-rings | \$2.82 | 0770440030 | | | | |
| | | | | | PV136032AFM | Left Side Power Valve Gasket | \$4.72 | 54837006000 | | | | |
| | | | | | PV137032AFM | Right Side Power Valve Gasket | \$5.00 | 54837008000 | | | | |
| | | | | | R112V | Power Valve Flap O-rings | \$1.19 | 0770116241 | | | | |
| | | | | | R114V | Power Valve Spring Guide O-ring | \$1.19 | 0770021120 | | | | |
| | | | | | R16X2V | Power Valve Control O-rings | \$3.02 | 0770160021 | | | | |
| | | | | | | | | 2 Req. | | | | |
| | | | | | | | | R24X2V | | Power Valve Control Cover O-ring | \$6.19 | 0770240020 |
| | | | | | | | | Clutch & Mag Kit | | | | |
| | | | C7943CM | \$27.47 | Component Part# | Component Description | List Price | OEM Part # | | | | |
| | | | | | EC234060AFM | Clutch Cover Gasket | \$12.39 | 54630025050 | | | | |
| | | | | | EC777032AFM | Mag Cover Gasket | \$11.75 | 54830040000 | | | | |

350 SX-F

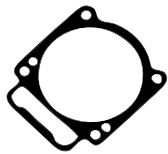

Head



Base

| Model | Year | Bore Size | Top End Kit | List Price | Component Part# | Component Description | List Price | OEM Part # |
|------------------|-------|-----------|-------------|------------|-----------------|-------------------------------|------------|-------------|
| 350SX-F | 11-12 | 88mm | C3428-EST | \$60.84 | H3093SP4027S | 88mm Cylinder Head Gasket | \$33.23 | 77230036000 |
| | | 90mm | C3429-EST | \$60.84 | H3093027S | 90mm Cylinder Head Gasket | \$33.23 | |
| | | 91mm | C3458-EST | \$60.84 | H3093SP1027S | 91mm Cylinder Head Gasket | \$33.23 | |
| | | | | | R10X2V | Water Temp Sensor O-ring | \$1.59 | 0770100020 |
| | | | | | R18X2.5V | Cam Chain Tensioner O-ring | \$1.71 | 0770180020 |
| | | | | | R9X2V | Head Seal O-rings | \$1.59 | 0770090015 |
| | | | | | WA145 | Cam Chain Tensioner Seal | \$2.16 | 0603242920 |
| | | | | | B1026014RC | Base Gasket | \$11.87 | 77230035000 |
| | | | | | 3231V | Valve Seals 4 Req. | \$6.48 ea. | 77236027000 |
| | | | | | R013V | Cam Chain Wear Bushing O-ring | \$1.08 | 0770010010 |
| | | | | | R023V | Plug Shaft O-rings | \$1.46 | 0770260015 |
| 350SX-F, XC-F | 13-14 | 88mm | C3519-EST | \$60.84 | 3231V | Valve Seals 4 Req. | \$6.48 ea. | 77236027000 |
| | | | | | R013V | Cam Chain Wear Bushing O-ring | \$1.08 | 0770010010 |
| | | | | | R023V | Plug Shaft O-rings | \$1.46 | 0770260015 |
| | | | | | R10X2V | Water Temp Sensor O-ring | \$1.59 | 0770100020 |
| | | | | | R018B | Cam Chain Tensioner O-ring | \$1.71 | 0770180020 |
| | | | | | R9X2V | Head Seal O-rings | \$1.59 | 0770090015 |
| | | | | | WA145 | Cam Chain Tensioner Seal | \$2.16 | 0603242920 |
| | | | | | H3093SP4032S | 88mm Cylinder Head Gasket | \$33.23 | 77230036000 |
| | | | | | H3093032S | 90mm Cylinder Head Gasket | \$33.23 | |
| | | | | | H3093SP1032S | 91mm Cylinder Head Gasket | \$33.23 | |
| | | | | | B1026014RC | Base Gasket | \$11.87 | 77230035000 |
| | | | | | EX1333059F | Exhaust Gasket | \$5.05 | 77236041000 |

350 EXC

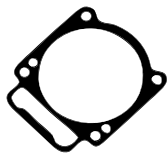

Base



Exhaust

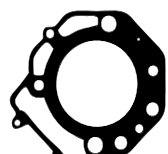

Head



Intake

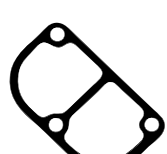

Valve Cover

| Model | Year | Bore Size | Top End Kit | List Price | Component Part# | Component Description | List Price | OEM Part # |
|-----------------|-------|-----------|-------------|------------|-----------------|---------------------------|------------|-------------|
| 350 EXC, RXC | 87-90 | O-Ring | C7288 | \$49.80 | H0378040A | Head Gasket | \$22.32 | 57530036000 |
| | | | | | B0230020RC | Base Gasket | \$8.75 | 58030030000 |
| | | | | | IR056032AFM | Intake Gasket | \$6.25 | 58136043000 |
| | | | | | EX088031F | Exhaust Gasket 2 Req. | \$6.25 | 58036041000 |
| | | | | | VC027032AFM | Valve Cover Gasket 2 Req. | \$4.72 | 58036053000 |

All Component Parts can be purchased individually.



MX/Dirt · Off-Road · ATV Gaskets



Cometic Gasket - An Exclusive NASCAR Performance® Product

KTM 360/380 SX

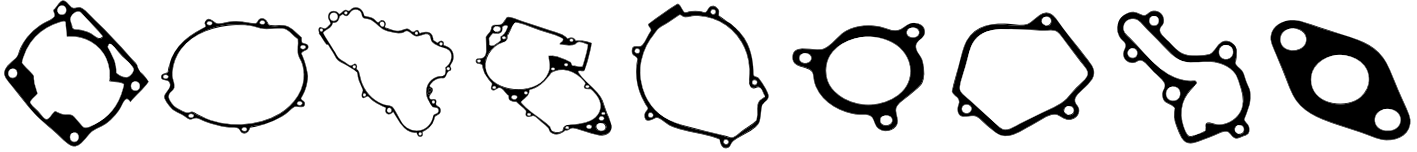

| Base | Outer Clutch | Inner Clutch | Center Case | Mag Cover | Exhaust | Power Valve | Water Pump | Water Pump |
|-------------|--------------|--------------|-------------------------------------|-------------------|------------------------|-------------------------------|-------------------|------------------|
| Model | Year | Bore Size | Top End Kit | List Price | Component Part# | Component Description | List Price | OEM Part # |
| 360 SX, EXC | 96-97 | O-Ring | C7285 | \$38.33 | R114X2B | Outer Head O-ring | \$4.00 | 0770114020 |
| 380 SX, EXC | 98-01 | | | | R84X2V | Inner Head O-ring | \$4.22 | 077084021 |
| | | | | | B0056018AFM | Base Gasket .018" | \$9.32 | 54630030005 |
| | | | | | B0056032AFM | Base Gasket .032" | \$6.25 | 54630030107 |
| | | | | | PV028018AFM | Right Side Power Valve Gasket | \$3.80 | 54637006100 |
| | | | | | PV049018AFM | Left Side Power Valve Gasket | \$3.80 | 54637106000 |
| | | | | | EX014047F | Exhaust Flange Gasket | \$4.65 | 54630046000 |
| | | | Bottom End Kit w/crank seals | List Price | Component Part# | Component Part# | List Price | OEM Part# |
| | | | C3390 | \$80.26 | EC234060AFM | Outer Clutch Cover Gasket | \$12.39 | 54630025050 |
| | | | | | EC285032AFM | Inner Clutch Cover Gasket | \$14.87 | 54630025200 |
| | | | | | EC286020F | Center Case Gasket | \$20.22 | 54630039200 |
| | | | | | EC287060AFM | Mag Cover Gasket | \$10.68 | 54630040300 |
| | | | | | WP008032AFM | Water Pump Gasket | \$3.80 | 54635003200 |
| | | | | | WP081032AFM | Power Valve Spring Cover | \$2.33 | 54435037000 |
| | | | Crank Seal Kit | List Price | Component Part# | Component Part# | List Price | OEM Part# |
| | | | C7662 | \$28.81 | OS136 | Right Crank Seal 24X35X7 | \$15.99 | 760253570 |
| | | | | | OS137 | Left Crank Seal 37X53X7 | \$15.99 | 760385273 |

400 LC4

| Model | Year | Bore Size | Top End Kit | List Price | Component Part# | Component Description | List Price | OEM Part # |
|-------------------|-------|-----------|-------------|------------|-----------------|-----------------------|------------|-------------|
| 400 LC4, MLS Head | 88-01 | 95.5 mm | C7170 | \$61.95 | H1955040S | 95.5mm Head Gasket | \$54.57 | 58030136200 |
| | | | | | B0230020RC | Base Gasket | \$8.75 | 58030030000 |

400/450/525 SX



| Base | Mag Cover | Timing Chain Tensioner | Clutch Cover | Center Case | Exhaust | Head | Valve Cover | |
|----------------------------|-----------|------------------------|---------------------------------------|-------------------|------------------------|------------------------------|-------------------|-------------------|
| Model | Year | Bore Size | EST | List Price | Component Part# | Component Description | List Price | OEM Part # |
| 400, 450, 525 SX, EXC, RFS | 00-06 | 91 mm | C7693-EST | \$71.71 | H1017040S | Head Gasket 91mm Bore | \$41.55 | 59030036000 |
| | | 94 mm | C7885-EST | \$71.71 | H1843040S | Head Gasket 94mm Bore | \$41.55 | |
| | | 95 mm | C7944-EST | \$71.71 | H1521040S | Head Gasket 95mm Bore | \$41.55 | |
| | | 96 mm | C7454-EST | \$71.71 | H2081040S | Head Gasket 96mm Bore | \$41.55 | |
| | | 97 mm | C7691-EST | \$71.71 | H1018040S | Head Gasket 97mm Bore | \$41.55 | |
| | | 98 mm | C7461-EST | \$71.71 | H1018SP4040S | Head Gasket 98mm Bore | \$41.55 | |
| | | 99 mm | C7792-EST | \$71.71 | H1018SP2040S | Head Gasket 99mm Bore | \$41.55 | |
| | | | | | B0480020F | Base Gasket | \$4.32 | 59030035050 |
| | | | | | EX281042AM | Exhaust Gasket | \$12.44 | 59036041000 |
| | | | | | EC495018AFM | Timing Cover Gasket | \$3.80 | 59036003050 |
| | | | | | 3225V | Valve Seals 4 Req. | \$1.76 ea. | 59036027000 |
| | | | | | VC027031F | 2 Req. Valve Cover Gasket | \$1.19 | 58036053000 |
| | | | | | R017B | Oil Screen Plug O-rings | \$1.14 | 0770020170 |
| | | | | | R12.5X2V | Oil Screen O-rings 2 Req. | \$3.74 | |
| | | | | | R40X2.5B | Oil Filter O-rings 2 Req. | \$3.74 | 0770400025 |
| | | | | | WA005063C | Oil Line Washers 4 Req. | \$0.57 | 0603082121 |
| | | | Bottom End Kit w/o crank seals | List Price | Component Part# | Component Part# | List Price | OEM Part# |
| | | | C3394 | \$43.63 | WP114018AFM | Water Pump Gasket | \$1.71 | 59035053000 |
| | | | | | EC496032AFM | Clutch Cover Gasket | \$17.38 | 59030025000 |
| | | | | | EC494032AFM | Mag Cover Gasket | \$17.38 | 59030040000 |
| | | | | | EC497012F | Center Case Gasket | \$17.38 | 59030039000 |
| | | | Clutch & Mag Kit | List Price | Component Part# | Component Description | List Price | OEM Part # |
| | | | C7693CM | \$34.76 | EC496032AFM | Clutch Cover Gasket | \$17.38 | 59030025000 |
| | | | | | EC494032AFM | Mag Cover Gasket | \$17.38 | 59030040000 |



MX/Dirt · Off-Road · ATV Gaskets



Cometic Gasket - An Exclusive NASCAR Performance® Product

KTM 450SX-F

| Model | Year | Bore Size | EST Top End Kit | List Price | Component Part# | Component Description | List Price | OEM Part # |
|-----------|-------|-----------|--------------------|------------|-----------------|-------------------------------|------------|-------------|
| 450SX-F | 07-10 | 97mm | C3412-EST | \$57.69 | H2623027S | Head Gasket 97mm Bore | \$29.11 | 77330036000 |
| 450 Rally | 14 | | | | R010V | Oil Jet O-rings | \$0.40 | 0770060015 |
| 450 SX | 07-10 | | | | R9X1.5V | Head Oil Plug O-ring | \$2.56 | 0770090015 |
| ATV | | | | | EX873059F | Exhaust Gasket | \$5.05 | 77336041000 |
| | | | | | R014V | Head Coolant Plug Gasket | \$1.08 | 0770090015 |
| | | | | | R25X2V | Cam Tower Plug Well O-ring | \$3.21 | 0770025020 |
| | | | | | 3225V | Valve Stem Seals | \$1.76 ea. | 59036027000 |
| | | | | | R013B | Cam Chain Tensioner O-ring | \$1.19 | 0770010010 |
| | | | | | WA145 | Cam Chain Tens. Crush Seal | \$2.16 | 0603242920 |
| | | | | | R18X2.5V | Cam Chain Tens. Piston O-ring | \$1.71 | 0770180020 |
| | | | | | R014V | Cam Chain Bushing O-ring | \$1.08 | 0770012015 |
| | | | | | R017B | Cam Axle O-ring | \$1.14 | 0770015018 |
| | | | | | R046V | Base O-ring | \$1.19 | 0770108018 |
| | | | | | B0928 | Cam Galley Base O-ring | \$4.75 | 77330035000 |

505 SX-F

| Model | Year | Bore Size | EST Top End Kit | List Price | Component Part# | Component Description | List Price | OEM Part # |
|---------|-------|-----------|--------------------|------------|-----------------|-------------------------------|------------|-------------|
| 505SX-F | 07-10 | 100mm | C3413-EST | \$57.69 | H2623SP1027S | Head Gasket 100mm Bore | \$29.11 | 77330036000 |
| 505 SX | 07-10 | | | | R010V | Oil Jet O-rings | \$0.40 | 0770060015 |
| ATV | | | | | R9X1.5V | Head Oil Plug O-ring | \$2.56 | 0770090015 |
| | | | | | EX873059F | Exhaust Gasket | \$5.05 | 77336041000 |
| | | | | | R014V | Head Coolant Plug Gasket | \$1.08 | 0770090015 |
| | | | | | R25X2V | Cam Tower Plug Well O-ring | \$3.21 | 0770025020 |
| | | | | | 3225V | Valve Stem Seals | \$1.76 ea. | 59036027000 |
| | | | | | R013B | Cam Chain Tens. O-ring | \$1.19 | 0770010010 |
| | | | | | WA145 | Cam Chain Tens. Crush Seal | \$2.16 | 0603242920 |
| | | | | | R18X2.5V | Cam Chain Tens. Piston O-ring | \$1.71 | 0770180020 |
| | | | | | R014V | Cam Chain Bushing O-ring | \$1.08 | 0770012015 |
| | | | | | R017B | Cam Axle O-ring | \$1.14 | 0770015018 |
| | | | | | R046V | Base O-ring | \$1.19 | 0770108018 |
| | | | | | B0928 | Cam Galley Base O-ring | \$4.75 | 77330035000 |

450/530 EXC-R

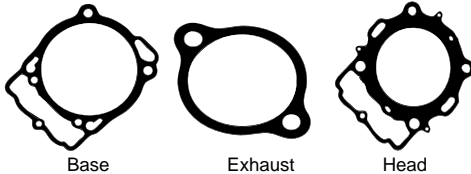

| Model | Year | Bore Size | EST Top End Kit | List Price | Component Part# | Component Description | List Price | OEM Part # |
|-----------|-------|-----------|--------------------|------------|-----------------|----------------------------|------------|-------------|
| 450 EXC-R | 08 | 95 mm | C3241-EST | \$61.31 | H2759045S | Head Gasket 95mm Bore | \$41.55 | 78030036000 |
| 530 EXC-R | | 97 mm | C3242-EST | \$61.31 | H2759SP3045S | Head Gasket 97mm Bore | \$41.55 | |
| 450 SX-F | 12 | 99 mm | C3243-EST | \$61.31 | H2759SP1045S | Head Gasket 99mm Bore | \$41.55 | |
| Factory | | 101 mm | C3244-EST | \$61.31 | H2759SP4045S | Head Gasket 101mm Bore | \$41.55 | |
| Replica | | | | | B0933014RC | Base Gasket | \$9.94 | 78030035000 |
| 450 SX-F | 13-14 | | | | EX873059F | Exhaust Gasket | \$5.05 | 77336041000 |
| | | | | | R019V | Cam Chain Tensioner O-ring | \$0.57 | 0770180020 |
| | | | | | WA145 | Cam Chain Tensioner Seal | \$2.16 | 603242920 |
| | | | | | 3225V | Intake Valve Seals 4 Req. | \$1.76 ea. | 59036027000 |
| | | | | | 3186V | Exhaust Valve Seals 2 Req. | \$4.99 ea. | 77036027000 |
| | | | | | R014V | Rocker Arm O-ring | \$1.08 | 0770110015 |
| | | | | | R10X2V | Temp Sensor O-ring | \$159 | 0770100020 |



MX/Dirt • Off-Road • ATV Gaskets



Cometic Gasket - An Exclusive NASCAR Performance® Product

450/525 XC

| Model | Year | Bore Size | EST Top End Kit | List Price | Component Part# | Component Description | List Price | OEM Part # | |
|---------------|---|-------------------|-----------------------|------------------------------|-------------------------------|-----------------------|-----------------------|-------------|--|
| 450 XC ATV | 08-10 | 89 mm | C3263-EST | \$68.99 | H1017SP2040S | Head Gasket 89mm Bore | \$41.55 | 59530036000 | |
| | | | C3264-EST | \$68.99 | H1017040S | Head Gasket 91mm Bore | \$41.55 | | |
| | | 91mm | B0480020RC | Base Gasket | \$9.94 | 59030035050 | | | |
| | | | 3225V | Valve Seals 4 Req. | \$1.76 ea. | 59036027000 | | | |
| | | | EC495018AFM | Cam Chain Tensioner Gasket | \$3.80 | 59036003050 | | | |
| | | | EX281042AM | Exhaust Gasket | \$12.44 | 59036041000 | | | |
| | | | R019V | Rocker Arm O-ring | \$0.57 | 770191016 | | | |
| | | | R40X2.5B | Oil Filter O-rings 2 Req. | \$3.74 | 770400025 | | | |
| | | | VC027031F | Valve Cover Gasket 2 Req. | \$1.19 | 58036053000 | | | |
| | | | WA005063C | Crush Washers 4 Req. | \$0.57 | 603061001 | | | |
| | | | WP114018AFM | Water Pump Gasket | \$1.71 | 59035053000 | | | |
| | | | | Component Description | List Price | OEM Part # | | | |
| | | | | EST Top End Kit | List Price | | | | |
| 525 XC ATV | 08-10 | 95 mm | C7944-EST | \$71.71 | H1521040S | Head Gasket 95mm Bore | \$41.55 | 5813169 | |
| | | | C7454-EST | \$71.71 | H2081040S | Head Gasket 96mm Bore | \$41.55 | | |
| | | 96 mm | C7691-EST | \$71.71 | H1018040S | Head Gasket 97mm Bore | \$41.55 | | |
| | | | 97 mm | C7461-EST | \$71.71 | H1018SP4040S | Head Gasket 98mm Bore | \$41.55 | |
| | | | | C7792-EST | \$71.71 | H1018SP2040S | Head Gasket 99mm Bore | \$41.55 | |
| | | | 98 mm | B0480020RC | Base Gasket | \$9.94 | 59030035050 | | |
| | | | | EC495018AFM | Timing Chain Tens. Gasket | \$3.80 | 59036003050 | | |
| | | | | EX281042AM | Exhaust Gasket | \$12.44 | 59036041000 | | |
| | | | | R017B | 2 Req.-Oil Screen Plug O-ring | \$1.14 | 5413248 | | |
| | | | | R12.5X2V | 2 Req.-Oil Screen Plug O-ring | \$3.74 | 5413249 | | |
| | | | | R40X2.5B | 2 Req.-Oil Filter O-ring | \$3.74 | 5413254 | | |
| | | | | VC027031F | Valve Cover Gasket 2 Req. | \$1.19 | 59530036000 | | |
| | | | | WA005063C | Crush Washers 4 Req. | \$0.57 | 603061001 | | |
| | Component Description | List Price | | OEM Part # | | | | | |
| | Bottom End Kit w/o crank seals | List Price | | OEM Part # | | | | | |
| C3340 | \$55.61 | WP114018AFM | | Water Pump Gasket | \$1.71 | 59035053000 | | | |
| | | EC1377020F | Ignition Cover Gasket | \$17.38 | 5813170 | | | | |
| | | EC494032AFM | Mag. Cover Gasket | \$17.38 | 5813174 | | | | |
| | | EC496032AFM | Clutch Cover Gasket | \$17.38 | 5413309 | | | | |
| | | EC497012F | Center Case Gasket | \$17.38 | 59030039000 | | | | |

KTM620 LC4

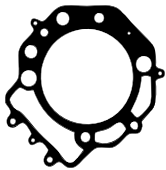

Base

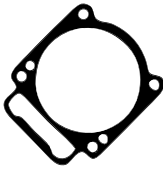

Exhaust

| Model | Year | Bore Size | Top End Kit | List Price | Component Part# | Component Description | List Price | OEM Part # |
|--------|-------|-----------|-------------|------------|-----------------|------------------------|------------|-------------|
| 620 LC | 88-01 | 102 mm | C7171 | \$61.95 | H1956040S | Head Gasket 102mm Bore | \$54.57 | 58330036000 |
| | | | C7209 | \$61.95 | H1957040S | Head Gasket 105mm Bore | \$54.57 | |
| | | 105 mm | | | B0230020RC | Base Gasket | \$8.75 | 58030030000 |



MX/Dirt · Off-Road · ATV Gaskets



Cometic Gasket - An Exclusive NASCAR Performance® Product

LEM

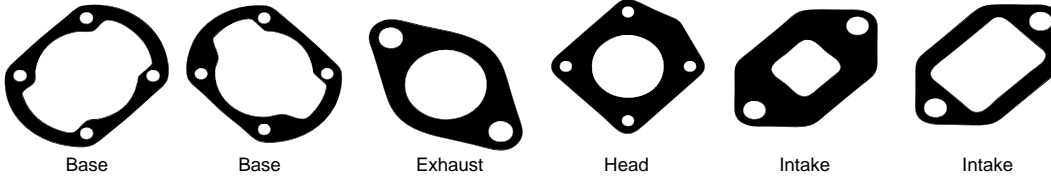

| Model | Year | Bore Size | Top End Kit | List Price | Component Part# | Component Description | List Price | OEM Part # |
|------------------|-------|-----------|-------------|------------|-----------------|---------------------------|------------|-------------|
| Cross | 96-03 | 41 mm | C7282 | \$31.91 | H0354010C | Head Gasket .010" Copper | \$9.37 | 36330036000 |
| CR-3 USA | | | | | H0354020C | Head Gasket .020" Copper | \$9.37 | 36330036000 |
| LX1, LX2 Factory | | | | | B0219018AFM | Base Gasket 00-01 | \$4.65 | 45030035800 |
| LX2, LX2 Sport | | | | | B0220018AFM | Base Gasket 94-99 | \$4.65 | 36330030000 |
| LX3 | | | | | IR054018AFM | Intake Port Small Opening | \$3.80 | 49130438000 |
| LX3 Sport | | | | | IR055018AFM | Intake Port Large Opening | \$3.80 | 49130438000 |
| | | | | | EX089039F | Exhaust Gasket | \$4.77 | 45030046000 |

POLARIS PREDATOR 90

| Model | Year | Bore Size | Top End Kit | List Price | Component Part# | Component Description | List Price | OEM Part # |
|-------------|-------|-----------|-------------|------------|-----------------|-----------------------|------------|------------|
| Predator 90 | 01-06 | 53mm | C3514 | \$15.99 | H2381SP1043F | Head Gasket | \$7.21 | 0450004 |
| | | | | | B0774020F | Base Gasket | \$5.05 | 0450009 |
| | | | | | EX650064AM | Exhaust Gasket | \$4.20 | 0450122 |

BIG BOSS

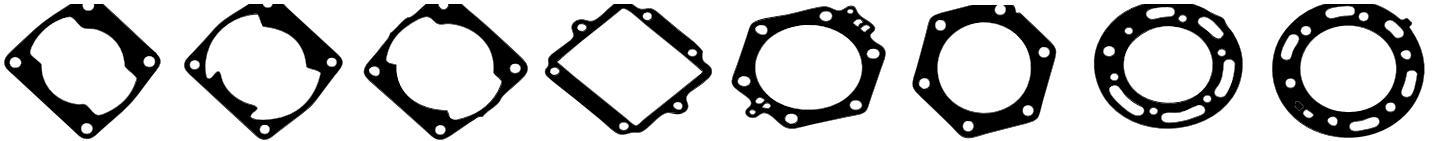

| Model | Year | Bore Size | Top End Kit | List Price | Component Part# | Component Description | List Price | OEM Part # |
|----------------|-------|-----------|-------------------|--------------------|-----------------|--------------------------------|------------|-----------------|
| Big Boss 4x6 | 89-92 | 72 mm | C7124 | \$21.76 | H0018043F | Head Gasket 72mm | \$19.82 | 3084015 |
| Big Boss 6x6 | 91-93 | 73.5 mm | C3485 | \$21.76 | H0018SP4040S | Head Gasket 73.5mm .040" Steel | \$19.82 | 3084015 |
| Cyclone | 87 | | | | B0070018AFM | Base Gasket | \$6.25 | 3083733/3084016 |
| Trail Blazer | 90-06 | | | | EX015042AM | Exhaust Gasket | \$3.48 | 3084026/3084439 |
| Trail Boss 2x4 | 85-96 | | | | | | | |
| Trail Boss 4x4 | 87-93 | | | | | | | |
| Trail Boss 6x6 | 88-93 | | | | | | | |
| 2x4 300 | 94-95 | 78 mm | Top End Kit C7310 | List Price \$21.76 | H0451020S | Head Gasket | \$13.62 | 3085098 |
| 4x4 300 | 94-95 | | | | B0265018AFM | Base Gasket | \$6.25 | 3084795 |
| 6x6 300 | 94-94 | | | | EX015042AM | Exhaust Gasket | \$3.48 | 3084026/3084439 |
| Xplorer 300 | 96-00 | | | | | | | |
| Xpress 300 | 96-00 | | | | | | | |
| Sportsman 4x4 | 93-93 | 82 mm | Top End Kit C7144 | List Price \$25.55 | H0212059F | Head Gasket | \$22.32 | 3084517 |
| Trail Boss 2x4 | 90-93 | | | | B0151020F | Base Gasket | \$7.16 | 3084140 |
| Trail Boss 4x4 | 90-93 | | | | EX015042AM | Exhaust Gasket | \$3.48 | 3084026/3084439 |
| Trail Boss 6x6 | 90-93 | | | | IR044018AFM | Intake Gasket | \$3.80 | 3084148 |

All Component Parts can be purchased individually.



MX/Dirt · Off-Road · ATV Gaskets



Cometic Gasket - An Exclusive NASCAR Performance® Product

POLARIS

| Model | Year | Bore Size | Top End Kit | List Price | Component Part# | Component Description | List Price | OEM Part # |
|-----------------|-------|-----------|-------------|------------|-----------------|-----------------------|------------|-----------------|
| 2x4 400L | 94-95 | 85 mm | C7265 | \$31.91 | H0345010S | Head Gasket | \$19.82 | 308415 |
| 4x4 400L | 94 | | | | B0206018AFM | Base Gasket | \$7.16 | 3084729 |
| 6x6 400L, | 94-03 | | | | EX015042AM | Exhaust Gasket | \$3.48 | 3084026/3084439 |
| Sportsman | | | | | IR044018AFM | Intake Gasket | \$3.80 | 3084148 |
| 4x4 | | | | | | | | |
| Scrambler | 95-00 | | | | | | | |
| 4x4 | | | | | | | | |
| Sport 400L, | 96-00 | | | | | | | |
| Trail Blazer ES | | | | | | | | |
| Xplorer | 95-00 | | | | | | | |
| 400L 4x4 | | | | | | | | |
| Xpress | 96-00 | | | | | | | |
| 400 | | | | | | | | |

| Model | Year | Bore Size | Top End Kit | List Price | Component Part# | Component Description | List Price | OEM Part # |
|--------|-------|-----------|-------------|------------|-----------------|-----------------------|------------|-----------------|
| Magnum | 95-00 | 92 mm | C7311 | \$49.80 | H0452059F | Head Gasket | \$34.75 | 3085337 |
| 2x4 | | | | | B0266020F | Base Gasket | \$7.16 | 3084851 |
| Magnum | 95-00 | | | | EX038042AM | Exhaust Gasket | \$4.26 | 3083575/3083023 |
| 4x4 | | | | | R015V | O-ring | \$1.13 | 3084867 |
| Magnum | 96 | | | | | | | |
| 6x6 | | | | | | | | |

SCRAMBLER

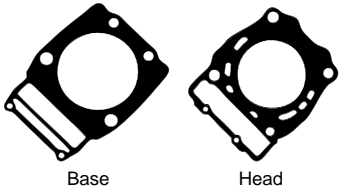

| Model | Year | Bore Size | Top End Kit | List Price | Component Part# | Component Description | List Price | OEM Part # |
|---------------|-------|-----------|-------------|------------|-----------------|-----------------------|------------|-----------------|
| Scrambler | 97-03 | 94 mm | C7312 | \$49.80 | H0453059F | Head Gasket | \$34.75 | 3084865 |
| 500 | | | | | B0267020F | Base Gasket | \$7.16 | 3084851 |
| Scrambler, | 97-05 | | | | EX038042AM | Exhaust Gasket | \$4.26 | 3083575/3083023 |
| Sportsman 500 | | | | | | | | |
| Xplorer 500 | 97 | | | | | | | |

PREDATOR

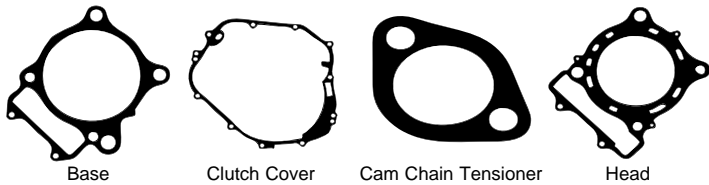

| Model | Year | Bore Size | Top End Kit | List Price | Component Part# | Component Description | List Price | OEM Part # |
|----------|-------|-----------|-------------|------------|-----------------|---------------------------------|-------------------|-------------------|
| Predator | 03-07 | 99 mm | C7971-EST | \$85.80 | H1818SP1027S | Head Gasket 99mm Bore | \$40.93 | 3087948 |
| 500 | | 100 mm | C7995-EST | \$85.80 | H1818030S | Head Gasket 100mm Bore | \$40.93 | |
| Outlaw | 06-07 | 103 mm | C7972-EST | \$85.80 | H1818SP4030S | Head Gasket 103mm Bore | \$40.93 | |
| 500 | | 105 mm | C3160-EST | \$85.80 | H1819030S | Head Gasket 105.5mm Bore | \$40.93 | |
| | | | | | B0658010RC | Base Gasket | \$9.32 | 3089519 |
| | | | | | EC996032AFM | Cam Chain Tensioner | \$2.33 | 3088022 |
| | | | | | EX634 | Exhaust Gasket/2 Req. | \$8.91 | 3087957 |
| | | | | | WA117 | 6 Req.-Oil Filter Copper Washer | \$0.95 | 3088044 |
| | | | | | 3243V | 4 Req. Valve Stem Seals" | \$1.53 | 3084908 |
| | | | | | | Component Part# | List Price | OEM Part # |
| | | | | | VC120 | Valve Cover Gasket | \$24.99 | 3089441 |



MX/Dirt · Off-Road · ATV Gaskets



Cometic Gasket - An Exclusive NASCAR Performance® Product

OUTLAW (KTM Motor)

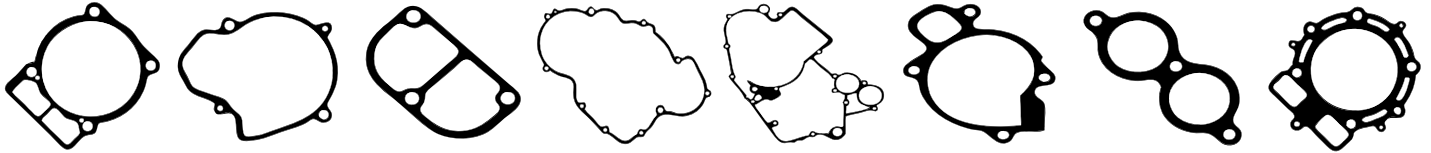

| Model | Year | Bore Size | EST | List Price | Component Part# | Component Description | List Price | OEM Part # | | |
|--------------------------------|------|-----------|--------------------|------------------------|------------------------|-----------------------|-------------------------------|------------|----------|--|
| Outlaw 52506-11 (KTM motor) | | 95 mm | Top End Kit | | | | | | | |
| | | | C7944-EST | \$71.71 | H1521040S | Head Gasket 95mm Bore | \$41.55 | 5813169 | | |
| | | | C7454-EST | \$71.71 | H2081040S | Head Gasket 96mm Bore | \$41.55 | | | |
| | | | C7691-EST | \$71.71 | H1018040S | Head Gasket 97mm Bore | \$41.55 | | | |
| | | | C7461-EST | \$71.71 | H1018SP4040S | Head Gasket 98mm Bore | \$41.55 | | | |
| | | | C7792-EST | \$71.71 | H1018SP2040S | Head Gasket 99mm Bore | \$41.55 | | | |
| | | | | | | B0480020F | Base Gasket | \$4.32 | 5813167 | |
| | | | | | | EC495018AFM | Timing Chain Tens. Gasket | \$3.80 | 5813173 | |
| | | | | | | EX281042AM | Exhaust Gasket | \$12.44 | 5813168 | |
| | | | | | | R017B | 2 Req.-Oil Screen Plug O-ring | \$1.14 | 5413248 | |
| | | | | | | R12.5X2V | 2 Req.-Oil Screen Plug O-ring | \$3.74 | 5413249 | |
| | | | | | | R40X2.5B | 2 Req.-Oil Filter O-ring | \$3.74 | 5413254 | |
| | | | | | | VC027031F | 2 Req.-Valve Cover Gasket | \$1.19 | 5813175 | |
| | | | | | | WA005063C | 4 Req.-Copper Washer | \$0.57 | 25437-86 | |
| | | | | | | | Bottom End Kit | | | |
| | | | | | | C3394 | List Price | \$43.63 | | |
| | | | | Component Part# | Component Part# | List Price | OEM Part# | | | |
| | | | | WP114018AFM | Water Pump Gasket | \$1.71 | 5813172 | | | |
| | | | | EC1377020F | Ignition Cover Gasket | \$17.38 | 5813170 | | | |
| | | | | EC494032AFM | Mag. Cover Gasket | \$17.38 | 5813174 | | | |
| | | | | EC496032AFM | Clutch Cover Gasket | \$17.38 | 5413309 | | | |
| | | | | EC497012F | Center Case Gasket | \$17.38 | 59030039000 | | | |

SUZUKI JR50

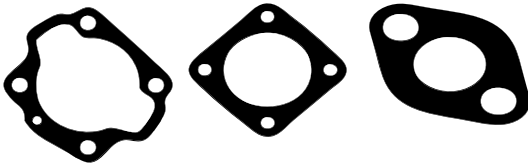

| Model | Year | Bore Size | Top End Kit | List Price | Component Part# | Component Description | List Price | OEM Part # |
|-------|-------|-----------|-------------|------------|-----------------|-----------------------|------------|-----------------|
| JR50 | 78-08 | 43 mm | C7014 | \$15.19 | H1281020RC | Head Gasket | \$6.25 | 11141-04000 |
| | | | | | B0543020RC | Base Gasket | \$6.02 | 11241-04010 |
| | | | | | IR417020F | Intake Gasket | \$1.71 | 13121-04000-H17 |
| | | | | | EX349042AM | Exhaust Gasket | \$3.58 | 14181-04200 |



MX/Dirt · Off-Road · ATV Gaskets



Cometic Gasket - An Exclusive NASCAR Performance® Product

LT50/RM60

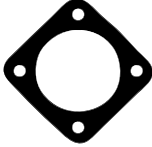
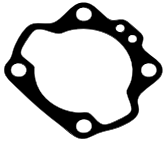

Base

Head

| Model | Year | Bore Size | Top End Kit | List Price | Component Part# | Component Description | List Price | OEM Part # |
|-------|-------|-----------|-------------|------------|-----------------|------------------------------|------------|-------------|
| LT50 | 84-87 | 43 mm | C7262 | \$16.06 | H0263010C | Head Gasket | \$14.20 | 11141-04000 |
| | | | | | B0161020F | Base Gasket | \$4.37 | 11241-04010 |
| RM60 | 03-04 | 45 mm | C7501 | \$22.99 | H0262043F | Head Gasket | \$17.38 | 11004-1218 |
| | | | | | B0371018AFM | Base Gasket | \$6.19 | 11060-1873 |
| | | | | | B0371012 | High Comp. Base Gasket .012" | \$6.19 | 11060-1873 |

| Bottom End Kit w/Oil Seals | List Price | Component Part# | Component Description | List Price # | OEM Part # |
|----------------------------|------------|-----------------|------------------------|--------------|------------|
| C7154BE | \$49.00 | R9X2V | Clutch Pushrod O-ring | \$1.59 | 670B1509 |
| | | WA107 | Drain Plug Seal | \$2.74 | 92065-058 |
| | | WP0500032AFM | Water Elbow Outlet | \$2.44 | 11009-1952 |
| | | R222V | Water Pump Body O-ring | \$3.92 | 670B3039 |
| | | WA107 | Trans Fluid Drain Plug | \$2.74 | 92065-058 |
| | | R013B | Output Shaft O-ring | \$1.19 | 92055-022 |

| Oil Seal Kit | List Price | Component Part# | Component Description | List Price # | OEM Part # |
|----------------|------------|-----------------|-------------------------------|--------------|------------|
| C7736OS | \$40.64 | OS331 | Shift Shaft Seal 13x22x5.5 | \$3.71 | 92051-005 |
| Crank Seal Kit | List Price | OS131 | Output Shaft Seal 25x37x6 | \$7.10 | 92050-013 |
| C7656 | \$16.99 | OS110 | Crank Seal 20x40x7 | \$9.47 | 92049-1188 |
| | | OS366 | Start Shaft Seal 16x24x4 | \$4.25 | 92049-002 |
| | | OS368 | Water Pump Shaft Seal 8x18x10 | \$8.75 | 92049-1366 |

| Clutch & Mag Kit | List Price | Component Part# | Component Description | List Price # | OEM Part # |
|------------------|------------|-----------------|-----------------------|--------------|------------|
| C7736CM | \$17.38 | EC275032AFM | Clutch Cover Gasket | \$8.69 | 11009-1976 |
| | | EC2740032AFM | Mag Cover Gasket | \$8.69 | 11009-1974 |

RM65

| Model | Year | Bore Size | Top End Kit | List Price | Component Part# | Component Part# | List Price | OEM Part# |
|-------|-------|-----------|-------------|------------|-----------------|-----------------------|------------|------------|
| RM65 | 03-08 | 45 mm | C7736 | \$22.99 | H0970010S | Head Gasket 45mm Bore | \$18.56 | 11004-1346 |
| | | 47 mm | C7682 | \$22.99 | H0971010S | Head Gasket 47mm Bore | \$18.56 | |
| | | 48 mm | C7737 | \$22.99 | H0972010S | Head Gasket 48mm Bore | \$18.56 | |

| Bottom End Kit w/Oil Seals | List Price | Component Part# | Component Description | List Price # | OEM Part # |
|----------------------------|------------|-----------------|-------------------------------|--------------|-------------|
| C7736BE | \$47.57 | WP104020F | Water Pump Gasket | \$2.16 | K1106-01924 |
| | | WP105020F | Water Outlet Gasket | \$2.16 | K1106-01927 |
| | | WA118 | Water Pump Drain Crush Washer | \$1.88 | KK920-22077 |
| | | R013B | Output Shaft O-rings | \$1.19 | KK920-55022 |
| | | WA108 | Drain Plug Gasket | \$2.56 | KK920-65058 |

| Oil Seal Kit | List Price | Component Part# | Component Description | List Price # | OEM Part # |
|----------------|------------|-----------------|-----------------------|--------------|-------------|
| C7736OS | \$40.64 | OS360 | Water Pump Seal Outer | \$5.31 | K9204-91359 |
| Crank Seal Kit | List Price | OS368 | Water Pump Seal Inner | \$8.48 | K9204-91366 |
| C7656 | \$16.99 | OS365 | Clutch Actuator Seal | \$2.50 | K9204-91414 |
| | | OS366 | Kickstart Seal | \$4.07 | KK920-49002 |
| | | OS131 | Output Shaft Seal | \$7.10 | KK920-50013 |
| | | OS331 | Shift Shaft Seal | \$3.71 | KK920-51005 |

| Clutch & Mag Kit | List Price | Component Part# | Component Description | List Price # | OEM Part # |
|------------------|------------|-----------------|-----------------------|--------------|------------|
| C7736CM | \$17.38 | EC275032AFM | Clutch Cover Gasket | \$8.69 | 11009-1976 |
| | | EC2740032AFM | Mag Cover Gasket | \$8.69 | 11009-1974 |



MX/Dirt · Off-Road · ATV Gaskets



Cometic Gasket - An Exclusive NASCAR Performance® Product

LT80

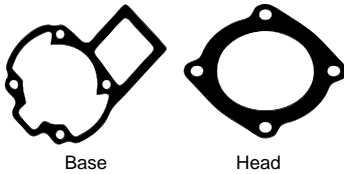

| Model | Year | Bore Size | Top End Kit | List Price | Component Part# | Component Description | List Price | OEM Part # |
|-------|-------|-----------|-------------|------------|-----------------|-----------------------|------------|--------------|
| LT80 | 87-06 | 52 mm | C7259 | \$30.84 | H0314020C | Head Gasket 52mm bore | \$17.15 | H11141-07910 |
| | | 54 mm | C7709 | \$30.84 | H0899020C | Head Gasket 54mm Bore | \$17.15 | |
| | | 55 mm | C7931 | \$30.84 | H0314SP4020C | Head Gasket 55mm Bore | \$17.15 | |
| | | | | | B0189020F | Base Gasket | \$4.65 | 11241-40B10 |

RM80

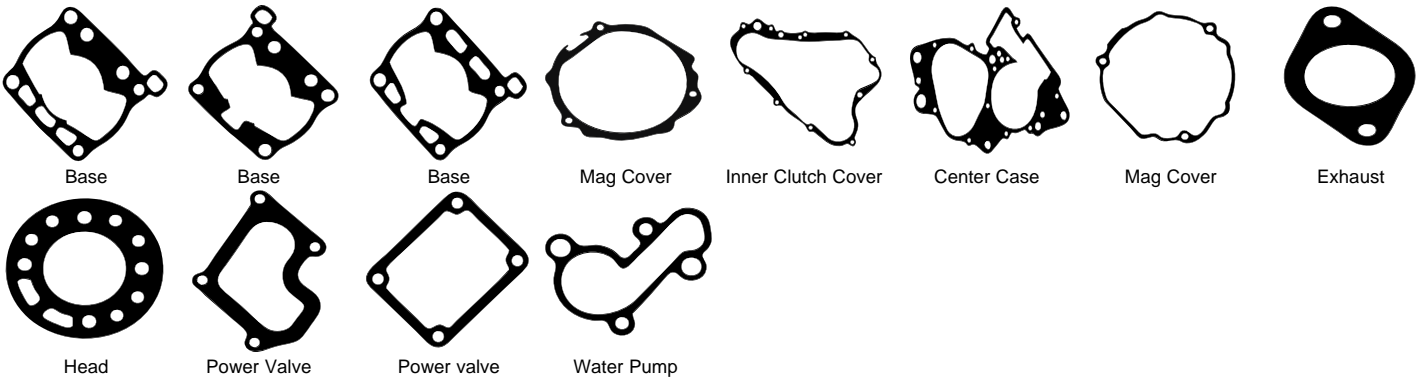

| Model | Year | Bore Size | Top End Kit | List Price | Component Part# | Component Description | List Price | OEM Part # |
|-----------------|-------------------------|-----------------------|-----------------------------------|--|-----------------------------------|--|--------------------------------|---|
| RM80 | 83-85 | 51 mm | C7102 | \$17.57 | H0038043F | Head Gasket 51mm | \$15.47 | 11141-20931-H17 |
| | | | | | B0037020F | Base Gasket | \$4.65 | 11241-20900-H17 |
| RM80 G, H, J | 86-88 | 50 mm | C7052 | \$21.76 | H0039043F | Head Gasket | \$14.87 | 1141-02B60 |
| | | | | | B0038020F | Base Gasket | \$4.65 | 11241-03B01 |
| | | | | | IR009020F | Intake Gasket | \$3.80 | 13156-02B00 |
| | | | | | EX010042AM | Exhaust Gasket | \$4.65 | 14181-02B00 |
| | | | Crank Seal Kit C7699 | List Price \$12.77 | Component Part# OS171 OS172 | Component Description 31X44X8 Right Crank Seal 17X30X8 Left Crank Seal | List Price \$9.47 \$4.72 | OEM Part# 09289-32003 09283-18004 |
| RM80 K | 89-90 | 50 mm | C7053 | \$22.99 | H0039043F | Head Gasket | \$14.87 | 1141-02B60 |
| | | | | | B0039020F | Base Gasket | \$4.65 | 11241-03B01 |
| | | | | | IR009020F | Intake Gasket | \$3.80 | 13156-02B00 |
| | | | | | EX010042AM | Exhaust Gasket | \$4.65 | 14181-02B00 |
| | | | | | PV015018AFM | Right Side Power Valve Gasket | \$3.80 | 11233-02B41 |
| | | | | | PV016018AFM | Front Power Valve Cover Gasket | \$3.80 | 11238-01B30-H17 |
| | | | | | R127V | Expansion Chamber O-ring | \$3.92 | 14171-02B40 |
| | Crank Seal Kit C7663 | List Price \$20.29 | Component Part# OS132 OS174 | Component Description 29X40X7 Right Crank Seal 17X30X6 Left Crank Seal | List Price \$16.64 \$5.91 | OEM Part# 09283-30061 9283-18006 | | |
| | | | Component Part# C7486 | Component Description Clutch Cover Gasket | List Price \$10.22 | OEM Part# 11482-27C00 | | |



MX/Dirt • Off-Road • ATV Gaskets



Cometic Gasket - An Exclusive NASCAR Performance® Product

SUZUKI

| Model | Year | Bore Size | Top End Kit | List Price | Component Part# | Component Part# | List Price | OEM Part# |
|-------|-------|-----------|-------------------------------------|-------------------|------------------------|--------------------------------|-------------------|------------------|
| RM80 | 91-01 | O-Ring | C7054 | \$22.99 | R55X2V | Inner Head O-ring | \$2.34 | 11147-03B00 |
| | | | | | R87X2B | Outer Head O-ring | \$11.87 | 11148-03B00 |
| | | | | | B0040018AFM | Base Gasket | \$9.32 | 11241-03B00 |
| | | | | | B0040012F | High Compression Base Gasket | \$4.65 | 11241-03B00 |
| | | | | | EX010042AM | Exhaust Gasket | \$4.65 | 14181-02B00 |
| | | | | | PV015018AFM | Right Side Power Valve Gasket | \$3.80 | 11233-02B41 |
| | | | | | PV016018AFM | Front Power Valve Cover Gasket | \$3.80 | 11238-01B30-H17 |
| | | | | | R127V | Expansion Chamber O-ring | \$3.92 | 14171-02B40 |
| | | | Bottom End Kit w/crank seals | List Price | Component Part# | Component Part# | List Price | OEM Part# |
| | | | C3357 | \$46.75 | EC204060AFM | Mag Cover Gasket | \$8.29 | 11483-02B50 |
| | | | | | C7486 | Inner Clutch Cover Gasket | \$10.22 | 11482-27C00 |
| | | | | | EC206020F | Crankcase Gasket | \$11.18 | 11481-02B40 |
| | | | | | WP040018AFM | Water Pump Cover Gasket | \$5.00 | 17431-02B41 |
| | | | Crank Seal Kit | List Price | Component Part# | Component Part# | List Price | OEM Part# |
| | | | C7663 | \$20.29 | OS132 | 29X40X7 Right Crank Seal | \$16.64 | 09283-30061 |
| | | | | | OS174 | 17X30X6 Left Crank Seal | \$5.91 | 9283-18006 |

RM85

| Model | Year | Bore Size | Top End Kit | List Price | Component Part# | Component Description | List Price | OEM Part # |
|-------|-------|-----------|-------------------------------------|-------------------|------------------------|------------------------------------|-------------------|-------------------|
| RM85 | 02-12 | O-Ring | C7857 | \$25.55 | R57X2V | inner Head O-ring | \$3.20 | 11147-03B00 |
| | | | | | R88X2B | Outer Head O-ring | \$1.36 | 11148-03B00 |
| | | | | | B0577018AFM | Base Gasket | \$4.65 | 11241-03B01 |
| | | | | | B0577012F | High Compression .012" Base Gasket | \$4.65 | |
| | | | | | R127V | Expansion Chamber O-ring | \$3.92 | 14171-02B40 |
| | | | | | PV015018AFM | Right Side Power Valve Cover | \$3.80 | 11233-02B41 |
| | | | | | PV016018AFM | Front Power Valve Cover Gasket | \$3.80 | 11238-01B30-H17 |
| | | | | | R015B | Oil Filler Cap O-ring | \$1.08 | NA |
| | | | Bottom End Kit w/crank seals | List Price | Component Part# | Component Description | List Price | OEM Part # |
| | | | C3358 | \$52.99 | C7486 | Clutch Cover Gasket | \$10.22 | 11482-27C00 |
| | | | | | EC653063N | Mag Cover Gasket | \$16.13 | 11481-02B41 |
| | | | | | EC654020F | Center Case Gasket | \$11.64 | 11481-03B00 |
| | | | | | R115B | Exhaust Valve Cover O-ring | \$1.13 | 09280-15006 |
| | | | | | WP040018AFM | Water Pump Gasket | \$5.00 | 17431-02B41 |
| | | | Clutch & Mag Kit | List Price | Component Part# | Component Description | List Price | OEM Part # |
| | | | C7857CM | \$26.35 | C7486 | Clutch Cover Gasket | \$10.22 | 11482-27C00 |
| | | | | | EC653063N | Mag Cover Gasket | \$16.13 | 11481-02B41 |
| | | | Crank Seal Kit | List Price | Component Part# | Component Part# | List Price | OEM Part# |
| | | | C7663 | \$20.29 | OS132 | 29X40X7 Right Crank Seal | \$16.64 | 09283-30061 |
| | | | | | OS174 | 17X30X6 Left Crank Seal | \$5.91 | 9283-18006 |

RM100

| Model | Year | Bore Size | Top End Kit | List Price | Component Part# | Component Description | List Price | OEM Part # |
|-------|-------|-----------|-------------------------------------|-------------------|------------------------|------------------------------|-------------------|-------------------|
| RM100 | 03-04 | 53 mm | C7392 | \$35.72 | H0342010S | Head Gasket 53mm Bore | \$20.99 | 11004-1214 |
| | | 54.5 mm | C7413 | \$35.72 | H0490010S | Head Gasket 54.5mm Bore | \$20.99 | |
| | | | | | B0311018AFM | Base Gasket | \$4.65 | 11060-1779 |
| | | | | | B0311012F | High Compression Base Gasket | \$6.25 | |
| | | | | | R126V | Expansion Chamber O-ring | \$1.19 | NA |
| | | | | | PV066018AFM | Rt. Side Power Valve Cover | \$3.80 | 11060-1778 |
| | | | Bottom End Kit w/crank seals | List Price | Component Part# | Component Part# | List Price | OEM Part# |
| | | | C3359 | \$17.63 | EC190018AFM | Clutch Cover Gasket | \$8.69 | 11009-1971 |
| | | | | | EC191018AFM | Mag Cover Gasket | \$8.69 | 11009-1973 |
| | | | | | WP036018AFM | Water Pump Gasket | \$3.74 | 11009-1972 |
| | | | Clutch & Mag Kit | List Price | Component Part# | Component Description | List Price | OEM Part # |
| | | | C3501CM | \$17.39 | EC190018AFM | Clutch Cover Gasket | \$8.69 | 11009-1971 |
| | | | | | EC191018AFM | Mag Cover Gasket | \$8.69 | 11009-1973 |



MX/Dirt · Off-Road · ATV Gaskets



Cometic Gasket - An Exclusive NASCAR Performance® Product

DR-Z110

| Model | Year | Bore Size | EST Top End Kit | List Price | Component Part# | Component Description | List Price | OEM Part # |
|---------|-------|-----------|--------------------|------------|------------------------|---------------------------------|-------------------|-------------------|
| DR-Z110 | 03-05 | 55 mm | C7939-EST | \$41.68 | H1891010S | Head Gasket 55mm | \$18.56 | K1100-41338 |
| | | 57 mm | C7949-EST | \$41.68 | H1917010S | Head Gasket 57mm | \$18.56 | |
| | | | | | B0678SP2020RC | Base Gasket | \$9.94 | K1106-01796 |
| | | | | | IR431018AFM | Intake Gasket | \$2.33 | K1106-01753 |
| | | | | | R022B | Intake O-rings 2 Req. | \$1.13 | K9205-51527 |
| | | | | | EX781 | Exhaust Gasket | \$3.35 | K1106-11112 |
| | | | | | R110B | Cam Chain Tensioner Bolt O-ring | \$1.13 | KK670-D2010 |
| | | | | | R117B | Cam Chain Tensioner O-ring | \$0.42 | KK670-D2021 |
| | | | | | 3183V | Valve Seals | \$5.50 | K9204-91349 |
| | | | | | R91X2.5V | Cam Cover O-ring | \$7.36 | K9205-51527 |
| | | | | | R031B | Tappet Cover O-rings 2 Req. | \$4.65 | K9205-51231 |
| | | | | | Component Part# | Component Description | List Price | OEM Part # |
| | | | | | EC1102018AFM | Clutch Cover Gasket | \$5.63 | 11061-0131 |

DR-Z125

| Model | Year | Bore Size | Top End Kit | List Price | Component Part# | Component Description | List Price | OEM Part # |
|---------|-------|-----------|-------------|------------|-----------------|----------------------------|------------|-------------|
| DR-Z125 | 03-13 | 59 mm | C7835 | \$29.11 | H1892027S | Head Gasket | \$18.56 | 11004-S004 |
| | | 61 mm | C3109 | \$29.11 | H1926027S | Head Gasket 61mm Bore | \$18.56 | |
| | | | | | B0679020F | Base Gasket | \$6.25 | 11061-S035 |
| | | | | | EC824032AFM | Cam Chain Tensioner Gasket | \$3.07 | 11061-S038 |
| | | | | | R010B | Cam Chain Bolt O-ring | \$0.62 | 09280-06005 |
| | | | | | R216B | Tappet Plug O-ring 2 Req. | \$3.74 | 09280-30001 |

SUZUKI RM125

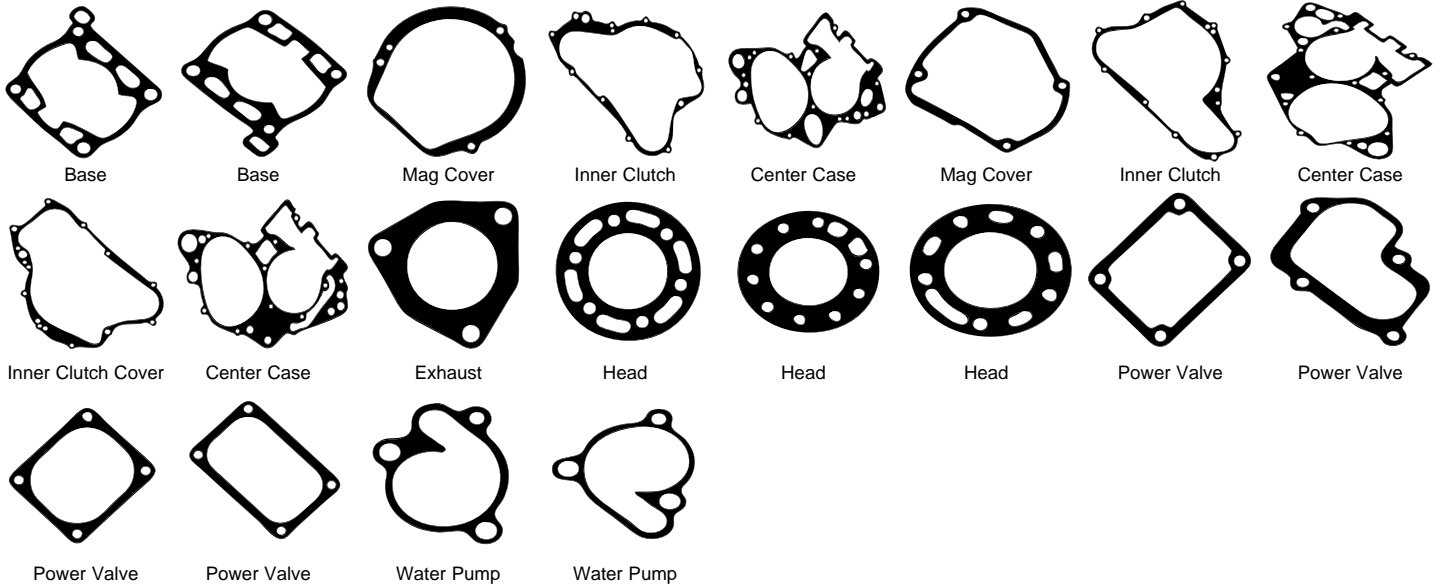

| Model | Year | Bore Size | Top End Kit | List Price | Component Part# | Component Description | List Price | OEM Part # |
|-------|---------|-----------|--------------------------|------------|-----------------------|-----------------------|------------------------|------------------------------|
| RM125 | 83 | 56 mm | C7103 | \$20.44 | H0040043F | Head Gasket | \$17.38 | 1141-14120-H17 |
| | | | | | B0041020F | Base Gasket | \$5.34 | 11241-14110-H17 |
| RM125 | 84-85 | 56 mm | C7055 | \$26.80 | B0042020F | Base Gasket | \$5.34 | 11241-14501-H17 |
| | | | | | EX011042AM | Exhaust Gasket | \$4.65 | 14181-40200 |
| | | | | | H0041043F | Head Gasket | \$17.38 | 11141-14500-H17 |
| | | | | | IR010020F | Intake Gasket | \$3.80 | 13156-14500-H17 |
| RM125 | 86 | 56 mm | C7056 | \$31.91 | B0043020F | Base Gasket | \$5.34 | 11241-01B00-H17 |
| | | | | | EX011042AM | Exhaust Gasket | \$4.65 | 14181-40200 |
| | | | | | H0042043F | Head Gasket | \$17.38 | 11141-01B01-H17 |
| | | | | | IR010020F | Intake Gasket | \$3.80 | 13156-14500-H17 |
| | | | | | PV017020F | Power Valve Gasket | \$3.80 | 11233-01B00 |
| | | | | | Crank Seal Kit | List Price | Component Part# | Component Description |
| | \$12.77 | OS173 | 27X40X8 Right Crank Seal | \$8.29 | 9289-28007 | | | |
| | | OS174 | 17X30X6 Left Crank Seal | \$5.91 | 9283-18006 | | | |

All Component Parts can be purchased individually.



MX/Dirt • Off-Road • ATV Gaskets



Cometic Gasket - An Exclusive NASCAR Performance® Product

SUZUKI

| Model | Year | Bore Size | Top End Kit | List Price | Component Part# | Component Description | List Price | OEM Part # | | | | | |
|-----------------------|-------------------------------|-------------------------|--------------------------|-------------------|-----------------------|-------------------------------|-------------------------|---------------------------|-------------------|------------------|-------------------|---------|-------------|
| RM125 | 87-88 | 56 mm | C7057 | \$31.91 | B0044020F | Base Gasket | \$5.34 | 11241-01B00-H17 | | | | | |
| | | | | | H0043043F | Head Gasket | \$17.38 | 11141-01B01-H17 | | | | | |
| | | | | | IR003018AFM | Intake Gasket | \$3.80 | 14132-K56-701 | | | | | |
| | | | | | PV016018AFM | Front Power Valve Gasket | \$3.80 | 11238-01B30-H17 | | | | | |
| | | | | | PV018020F | Right Power Valve Gasket | \$3.80 | 11233-01B30 | | | | | |
| | | | | | R224V | Power Valve O-ring | \$1.19 | 09280-28005 | | | | | |
| | | | | | Crank Seal Kit | List Price | Component Part# | Component Part# | List Price | OEM Part# | | | |
| | | | | | C7700 | \$12.77 | OS173 | 27X40X8 Right Crank Seal | \$8.29 | 9289-28007 | | | |
| | | | | | OS174 | | 17X30X6 Left Crank Seal | \$5.91 | 9283-18006 | | | | |
| | | | | | RM125 | 89 | 56 mm | C7058 | \$31.91 | H0044043F | Head Gasket | \$17.38 | 11141-27C00 |
| B0045018AFM | Base Gasket | \$9.32 | 11241-27C10 | | | | | | | | | | |
| PV016018AFM | Front Power Valve Gasket | \$3.80 | 11238-01B30-H17 | | | | | | | | | | |
| PV019020F | Right Power Valve Gasket | \$3.80 | 11233-27C10 | | | | | | | | | | |
| R224V | Power Valve O-ring | \$1.19 | 09280-28005 | | | | | | | | | | |
| Crank Seal Kit | List Price | Component Part# | Component Part# | List Price | | | | | | OEM Part# | | | |
| C7664 | \$20.29 | OS132 | 29X40X7 Right Crank Seal | \$16.64 | | | | | | 09283-30061 | | | |
| OS174 | | 17X30X6 Left Crank Seal | \$5.91 | 9283-18006 | | | | | | | | | |
| RM125 | 90 | O-Ring | C7120 | \$31.91 | | | | | | R62X2V | Inner Head O-ring | \$4.64 | 11147-27C10 |
| | | | | | | | | | | R89X2B | Outer Head O-ring | \$2.86 | 11148-27C10 |
| | | | | | B0045018AFM | Base Gasket | \$9.32 | 11241-27C10 | | | | | |
| | | | | | PV016018AFM | Front Power Valve Gasket | \$3.80 | 11238-01B30-H17 | | | | | |
| | | | | | PV019020F | Right Power Valve Gasket | \$3.80 | 11233-27C10 | | | | | |
| | | | | | R224V | Power Valve O-ring | \$1.19 | 09280-28005 | | | | | |
| | | | | | Crank Seal Kit | List Price | Component Part# | Component Part# | List Price | OEM Part# | | | |
| | | | | | C7664 | \$20.29 | OS132 | 29X40X7 Right Crank Seal | \$16.64 | 09283-30061 | | | |
| | | | | | OS174 | | 17X30X6 Left Crank Seal | \$5.91 | 9283-18006 | | | | |
| | | | | | RM125 | 91 | O-Ring | C7059 | \$31.91 | R62X2V | Inner Head O-ring | \$4.64 | 11147-27C10 |
| R89X2B | Outer Head O-ring | \$2.86 | 11148-27C10 | | | | | | | | | | |
| B0045018AFM | Base Gasket | \$9.32 | 11241-27C10 | | | | | | | | | | |
| PV020018AFM | Right Side Power Valve Gasket | \$3.80 | 11233-27C32 | | | | | | | | | | |
| PV021032AFM | Front Power Valve Gasket | \$3.80 | 11238-27C31 | | | | | | | | | | |
| Crank Seal Kit | List Price | Component Part# | Component Part# | List Price | | | | | | OEM Part# | | | |
| C7664 | \$20.29 | OS132 | 29X40X7 Right Crank Seal | \$16.64 | | | | | | 09283-30061 | | | |
| OS174 | | 17X30X6 Left Crank Seal | \$5.91 | 9283-18006 | | | | | | | | | |
| RM125 | 92 | O-Ring | C7112 | 31.91 | | | | | | R62X2V | Inner Head O-ring | 4.64 | 11147-27C10 |
| | | | | | | | | | | R89X2B | Outer Head O-ring | 2.86 | 11148-27C10 |
| | | | | | B0045018AFM | Base Gasket | 9.32 | 11241-27C10 | | | | | |
| | | | | | PV020018AFM | Right Side Power Valve Gasket | 3.80 | 11233-27C32 | | | | | |
| | | | | | PV021032AFM | Front Power Valve Gasket | 3.80 | 11238-27C31 | | | | | |
| | | | | | Bottom End Kit | List Price | Component Part# | Component Part# | List Price | OEM Part# | | | |
| | | | | | C3360 | 58.27 | EC207060AFM | Mag Cover Gasket | 8.29 | 11483-43D00 | | | |
| | | | | | | | EC208032AFM | Inner Clutch Cover Gasket | 9.99 | 11482-43D01 | | | |
| | | | | | | | EC210020F | Center Case Gasket | 13.62 | 11481-43D00 | | | |
| | | | | | | | C7499 | Outer Clutch Cover Gasket | 13.99 | 11484-43D00 | | | |
| | | WP041018AFM | Water Pump Gasket | 4.37 | 17431-43D00 | | | | | | | | |
| Crank Seal Kit | List Price | Component Part# | Component Part# | List Price | OEM Part# | | | | | | | | |
| C7664 | 20.29 | OS132 | 29X40X7 Right Crank Seal | 16.64 | 09283-30061 | | | | | | | | |
| | | OS174 | 17X30X6 Left Crank Seal | 5.91 | 9283-18006 | | | | | | | | |



MX/Dirt · Off-Road · ATV Gaskets



Cometic Gasket - An Exclusive NASCAR Performance® Product

SUZUKI

| Model | Year | Bore Size | Top End Kit | List Price | Component Part# | Component Description | List Price | OEM Part # | | | | |
|-----------------------------|-------------------|------------------------|-------------------------------|---------------------|---------------------------------------|------------------------------------|------------------------|------------------------------|---------------------|---------------------|--|--|
| RM125 | 93-97 | O-Ring | C7136 | \$31.91 | R62X2V | Inner Head O-ring | \$4.64 | 11147-27C11 | | | | |
| | | | | | R89X2B | Outer Head O-ring | \$2.86 | 11148-27C11 | | | | |
| | | | | | B0045018AFM | Base Gasket | \$9.32 | 11241-27C10 | | | | |
| | | | | | B0045012F | High Comp. Base Gasket .012" | \$9.32 | | | | | |
| | | | | | PV020018AFM | Right Side Power Valve Gasket | \$3.80 | 11233-27C32 | | | | |
| | | | | | PV021032AFM | Front Power Valve Gasket | \$3.80 | 11238-27C31 | | | | |
| | | | | | PV061018AFM | Front Power Valve Gasket 97-Up | \$3.80 | 11238-36E00 | | | | |
| | | | | | Bottom End Kit w/crank seals | List Price | Component Part# | Component Part# | List Price | OEM Part# | | |
| | | | | | C3360 | \$58.27 | EC207060AFM | Mag Cover Gasket | \$8.29 | 11483-43D00 | | |
| | | | | | | | EC208032AFM | Inner Clutch Cover Gasket | \$9.99 | 11482-43D00 / 43D01 | | |
| | | | | | | | EC210020F | Center Case Gasket | \$13.62 | 11481-43D00 | | |
| | | | | | | | C7499 | Outer Clutch Cover Gasket | \$13.99 | 11484-43D00 | | |
| | | | | | | | WP041018AFM | Water Pump Gasket | \$4.37 | 17431-43D00 | | |
| Clutch & Mag Kit | List Price | Component Part# | Component Description | List Price | OEM Part # | | | | | | | |
| C7857CM | \$26.35 | C7486 | Clutch Cover Gasket | \$10.22 | 11482-27C00 | | | | | | | |
| | | EC653063N | Mag Cover Gasket | \$16.13 | 11481-02B41 | | | | | | | |
| Crank Seal Kit | List Price | Component Part# | Component Part# | List Price | OEM Part# | | | | | | | |
| C7664 | \$20.29 | OS132 | 29X40X7 Right Crank Seal | \$16.64 | 09283-30061 | | | | | | | |
| | | OS174 | 17X30X6 Left Crank Seal | \$5.91 | 9283-18006 | | | | | | | |
| RM125 | 98-00 | O-Ring | C7136 | \$31.91 | R62X2V | Inner Head O-ring | \$4.64 | 11147-27C11 | | | | |
| | | | | | R89X2B | Outer Head O-ring | \$2.86 | 11148-27C11 | | | | |
| | | | | | B0045018AFM | Base Gasket | \$9.32 | 11241-27C10 | | | | |
| | | | | | B0045012F | High Compression Base Gasket .012" | \$9.32 | | | | | |
| | | | | | PV020018AFM | Right Side Power Valve Gasket | \$3.80 | 11233-27C32 | | | | |
| | | | | | PV021032AFM | Front Power Valve Gasket | \$3.80 | 11238-27C31 | | | | |
| | | | | | PV061018AFM | Front Power Valve Gasket 97-Up | \$3.80 | 11238-36E00 | | | | |
| | | | | | Bottom End Kit w/o crank seals | List Price | Component Part# | Component Part# | List Price | OEM Part# | | |
| | | | | | C3361 | \$40.51 | EC211018AFM | Mag Cover Gasket | \$8.29 | 11483-36E10 | | |
| | | | | | | | EC212032AFM | Inner Clutch Cover Gasket | \$8.29 | 11482-36E10 | | |
| | | | | | | | C7499 | Outer Clutch Cover Gasket | \$13.99 | 11484-43D00 | | |
| | | | | | | | EC214020F | Center Case Gasket | \$14.87 | 11481-36E10 | | |
| | | | | | | | WP041018AFM | Water Pump Gasket | \$4.37 | 17431-43D00 | | |
| RM125 | 01-03 | O-Ring | C7778 | \$31.91 | R89X2B | Outer Head O-ring | \$2.86 | 11148-27C11 | | | | |
| | | | | | R63X2V | Inner Head O-ring | \$4.57 | 11147-27C11 | | | | |
| | | | | | B0045018AFM | Base Gasket | \$9.32 | 11241-27C10 | | | | |
| | | | | | PV020018AFM | Right Side Power Valve Gasket | \$3.80 | 11233-27C32 | | | | |
| | | | | | PV061018AFM | Front Power Valve Gasket 97-Up | \$3.80 | 11238-36E00 | | | | |
| | | | | | WA123 | Head Crush Washer | \$1.96 | 09168-08021 | | | | |
| | | | | | Bottom End Kit w/Oil Seals | List Price | Component Part# | Component Description | List Price # | OEM Part # | | |
| | | | | | C7778BE | \$81.71 | EC871020F | Center Case Gasket K1-K4 | \$23.80 | 11481-36F20/11481 | | |
| | | | | | | | WA125 | Drain Plug Gasket | \$2.23 | 09168-12002 | | |
| | | | | | | | EC502032AFM | Inner Clutch Cover Gasket | \$8.29 | 11484-36E10 | | |
| | | | | | | | R116B | Oil Fill Plug Gasket | \$1.13 | 09280-17003 | | |
| | | | | | | | WP124060AFM | Water Pump Cover Gasket | \$5.34 | 17431-36F00 | | |
| | | | | | | | WA124 | Water Pump Drain Gasket | \$2.22 | 09168-06004 | | |
| | | R20X2V | Output Shaft O-rings | \$3.02 | 09280-20006 | | | | | | | |
| Oil Seal Kit | List Price | Component Part# | Component Description | List Price # | OEM Part # | | | | | | | |
| C7778OS | \$47.35 | OS364 | Impeller Seal K1-K3 12x24x10 | \$5.89 | 17461-03B00 | | | | | | | |
| Crank Seal Kit | List Price | Component Part# | Component Description | List Price # | OEM Part # | | | | | | | |
| C7784 | \$28.11 | OS305 | Shift Shaft Seal 14X22X6 | \$5.77 | 09283-14006 | | | | | | | |
| | | OS244 | Clutch Pushrod Seal 10X17X5.0 | \$1.43 | 09285-10004 | | | | | | | |
| | | OS235 | Output Shaft Seal K1-K3 28x | \$6.85 | 09283-28020 | | | | | | | |
| | | OS215 | Start Shaft Seal 15.8X24X5 | \$4.86 | 09283-16004 | | | | | | | |
| | | OS174 | Left Crank Seal 18X30X6 | \$5.91 | 09283-18007 | | | | | | | |
| | | OS132 | Right Crank Seal 30X40X7 | \$16.64 | 09283-30061 | | | | | | | |
| Clutch & Mag Kit | List Price | Component Part# | Component Description | List Price | OEM Part # | | | | | | | |
| C7778CM | 21.28 | EC213 | Outer Clutch Cover | \$12.99 | 11482-36F00 | | | | | | | |
| | | EC211018AFM | Mag Cover Gasket | \$8.29 | 11483-36E11 | | | | | | | |



MX/Dirt · Off-Road · ATV Gaskets



Cometic Gasket - An Exclusive NASCAR Performance® Product

SUZUKI

| Model | Year | Bore Size | Top End Kit | List Price | Component Part# | Component Description | List Price | OEM Part # |
|-------|-------|-----------|-------------|------------|-----------------|------------------------------|------------|-------------|
| RM125 | 04-07 | O-Ring | C7508 | \$35.10 | R63X2V | Inner Head O-ring | \$4.57 | 11147-37F00 |
| | | | | | R89X2B | Outer Head O-ring | \$2.86 | 11148-37F00 |
| | | | | | B0705018AFM | Base Gasket | \$6.01 | 11241-36F00 |
| | | | | | B0705012F | High Comp. Base Gasket .012" | \$9.56 | |
| | | | | | EX640 | Exhaust Gasket | \$6.93 | 11483-36E10 |
| | | | | | PV020018AFM | Right Side Power Valve | \$3.80 | 11484-43D00 |
| | | | | | PV061018AFM | Front Power Valve Gasket | \$3.80 | 11482-36F00 |
| | | | | | WA123 | Head Crush Washer | \$1.96 | 09168-08021 |

| Bottom End Kit w/Oil Seals | | List Price | Component Part# | Component Description | List Price # | OEM Part # |
|----------------------------|--|------------|-----------------|-------------------------------|--------------|-------------|
| C7508BE | | \$82.48 | EC502032AFM | Inner Clutch(Primary) Cover | \$3.80 | 11482-36F00 |
| | | | EC871020F | Center Case Gasket | \$3.80 | 11481-36F30 |
| | | | R116B | Fill Plug Gasket (Trans.) | \$1.13 | 09280-17003 |
| | | | R20X2V | Output Shaft O-ring | \$3.02 | 09280-20006 |
| | | | WA124 | Water Pump Drain Crush Washer | \$2.22 | 09168-06004 |
| | | | WA125 | Drain Plug Gasket | \$2.32 | 09168-12002 |
| | | | WP124032AFM | Water Pump Cover Gasket | \$5.34 | 17431-36F00 |

| Oil Seal Kit | List Price | Component Part# | Component Description | List Price # | OEM Part # |
|----------------|------------|-----------------|--------------------------|--------------|-------------|
| C7508OS | \$47.02 | OS132 | Right Crank Seal | \$16.64 | 09283-30061 |
| Crank Seal Kit | List Price | Component Part# | Component Description | List Price # | OEM Part # |
| C7784 | \$28.11 | OS174 | Left Crank Seal | \$5.91 | 09283-18007 |
| | | OS215 | Kickstart Seal | \$4.86 | 09283-16004 |
| | | OS216 | Water Pump Oil Seal | \$5.65 | 17461-37F00 |
| | | OS244 | Clutch Pushrod Oil Seal | \$1.43 | 09285-10004 |
| | | OS305 | Shift Shaft Seal 14x22x6 | \$5.77 | 09283-14006 |
| | | OS367 | Output Shaft Seal | \$6.76 | 09289-28012 |

| Clutch & Mag Kit | List Price | Component Part# | Component Description | List Price | OEM Part# |
|------------------|------------|-----------------|-----------------------|------------|-------------|
| C7508CM | \$22.28 | C7499 | Clutch Cover O-ring | \$13.99 | 11484-36E10 |
| | | EC211032AFM | Mag Cover Gasket | \$8.29 | 11483-36E11 |

LT230

| Model | Year | Bore Size | Top End Kit | List Price | Component Part# | Component Description | List Price | OEM Part # |
|-------|-------|-----------|-------------|------------|-----------------|-----------------------|------------|-------------|
| LT230 | 85-93 | 67 mm | C7074 | \$33.79 | H0056SP1043F | 67mm Bore Head Gasket | \$19.82 | 11141-18A00 |
| | | 71 mm | C7329 | \$33.79 | H0425043C | 71mm Bore Head Gasket | \$24.98 | |
| | | | | | B0055020F | Base Gasket | \$5.34 | 11241-18A20 |

LT250R

| Model | Year | Bore Size | Top End Kit | List Price | Component Part# | Component Description | List Price | OEM Part # |
|--------|-------|-----------|------------------------------|------------|-----------------|-------------------------------|------------|----------------------|
| LT250R | 85-86 | 72 mm | C7070 | \$34.47 | H0051043F | Head Gasket | \$19.82 | 11141-13A60 |
| | | | | | B0053020F | Base Gasket | \$6.25 | 11482-19A00-H17 |
| | | | | | IR012020F | Intake Gaskets | \$3.80 | 13156-13A00 |
| | | | Bottom End Kit w/crank seals | List Price | Component Part# | Component Description | List Price | OEM Part# |
| | | | C3363 | \$29.48 | C7719 | Clutch Cover Gasket | \$15.28 | 11483-13A00 |
| | | | | | EC325020F | Mag Cover Gasket | \$4.09 | |
| | | | Crank Seal Kit | List Price | Component Part# | Component Description | List Price | OEM Part# |
| | | | C7676 | \$16.99 | OS147 | 35X52X8 Left Crank Seal | \$12.99 | 09289-36003 |
| | | | | | OS148 | 24X38X7 Right Crank Seal | \$5.91 | 09283-25078 |
| LT250R | 87-92 | 69 mm | Top End Kit | List Price | Component Part# | Component Description | List Price | OEM Part # |
| | | 74 mm | C7071 | \$38.33 | H0268043F | Head Gasket | \$21.76 | 11141-01C01-H17 |
| | | | C7422 | \$38.33 | H2230043F | Head Gasket 74mm Bore | \$21.76 | |
| | | | | | B0047020F | Base Gasket | \$6.25 | 11241-01C10 |
| | | | | | IR011018AFM | Intake Gasket | \$3.48 | 3008-076/13156-01C10 |
| | | | | | IR176020F | Intake Gasket | \$3.80 | 13156-01C10 |
| | | | | | PV022018AFM | Right Side Power Valve Gasket | \$3.80 | 11233-00B00-H17 |
| | | | Bottom End Kit w/crank seals | List Price | Component Part# | Component Description | List Price | OEM Part# |
| | | | C3364 | \$37.39 | C7720 | Clutch Cover Gasket | \$15.28 | 11482-01C10 |
| | | | | | EC323020F | Mag Cover Gasket | \$8.29 | 11483-01C10 |
| | | | | | WP074020F | Water Pump Gasket | \$4.15 | 17431-14303 |
| | | | Crank Seal Kit | List Price | Component Part# | Component Description | List Price | OEM Part# |
| | | | C7675 | \$16.85 | OS145 | 35X52X8 Left Side Crank Seal | \$9.47 | 09283-36004 |
| | | | | | OS146 | 24X38X7 Right Side Crank Seal | \$9.26 | 09283-25082 |



MX/Dirt · Off-Road · ATV Gaskets



Cometic Gasket - An Exclusive NASCAR Performance® Product

SUZUKI LT250

| Model | Year | Bore Size | Top End Kit | List Price | Component Part# | Component Description | List Price | OEM Part # |
|----------------|-------|-----------|-------------|------------|-----------------|--|------------|-------------|
| LT-F250 | 88-13 | 69 mm | C7260 | \$38.33 | H0364043F | Head Gasket | \$30.95 | 11141-19B00 |
| LT-4WDX | 87-96 | 71 mm | C7261 | \$38.33 | H0363043F | Head Gasket 71mm Bore | \$30.95 | |
| King Quad 4 WD | 91-00 | 70.5 mm | C7314 | \$38.33 | B0055020F | Base Gasket LT250F 87-97 LT-FWDX 87-99 | \$5.34 | 11241-38300 |
| | | | | | B0213020F | Base Gasket LT250S 89-90 | \$6.25 | 11241-25C10 |
| | | | | | B0214020F | Base Gasket LTF4WDX 87-99 King Quad 99-00 | \$6.25 | 11241-18A20 |

RM250

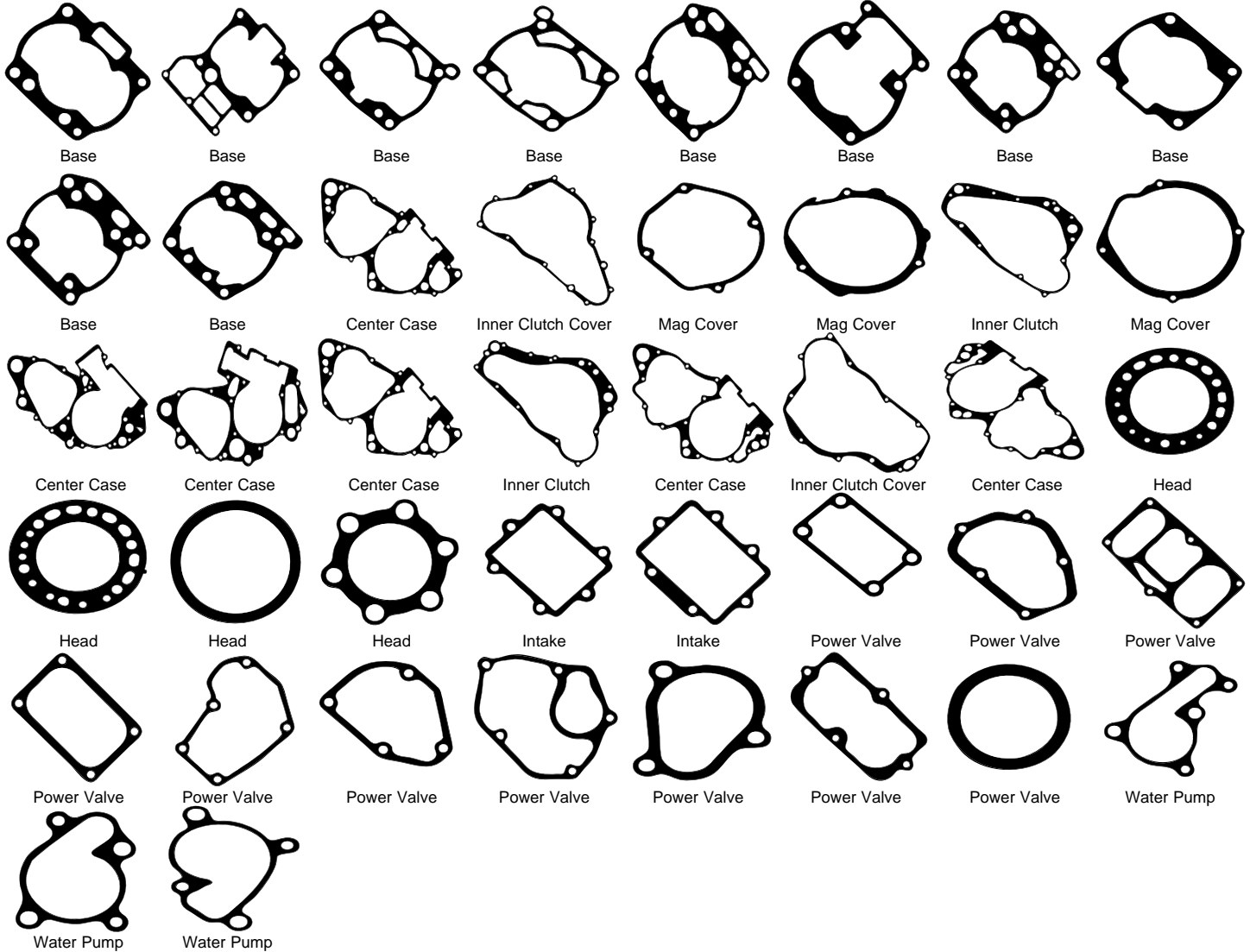

| Model | Year | Bore Size | Top End Kit | List Price | Component Part# | Component Description | List Price | OEM Part # |
|-------|-------|-----------|-------------|------------|-----------------|-----------------------|------------|-----------------|
| RM250 | 77-80 | 69 mm | C7468 | \$29.35 | B0350020F | Base Gasket | \$9.32 | 11241-41100-H17 |
| | | | | | H0738016A | Head Gasket | \$19.82 | 11141-41610 |
| RM250 | 81 | 69 mm | C7814 | \$29.35 | B0446020F | Base Gasket | \$8.69 | 11241-14201 |
| | | | | | H0966043F | Head Gasket | \$20.99 | 11141-14202 |
| RM250 | 83 | 72 mm | C7104 | \$25.55 | B0046020F | Base Gasket | \$6.25 | 11241-14600-H17 |
| | | | | | H0045043F | Head Gasket | \$19.82 | 11141-13A60 |
| RM250 | 84-85 | 72 mm | C7060 | \$34.47 | B0046020F | Base Gasket | \$6.25 | 11241-14600-H17 |
| | | | | | EX012031F | Exhaust Gasket | \$4.65 | 14181-16300 |
| | | | | | H0045043F | Head Gasket | \$19.82 | 11141-13A60 |

All Component Parts can be purchased individually.



MX/Dirt • Off-Road • ATV Gaskets



Cometic Gasket - An Exclusive NASCAR Performance® Product

SUZUKI

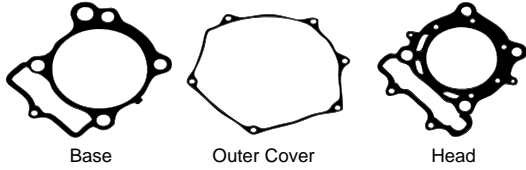

| Model | Year | Bore Size | Top End Kit | List Price | Component Part# | Component Description | List Price | OEM Part # | | | | |
|--------------------|---------|-----------|-----------------------------|-------------------------|-----------------------|-------------------------------|-------------------------------|------------------------------|------------------------------|------------------------|-------------------|------------------|
| RM250 | 86 | 69 mm | C7061 | \$33.14 | B0047020F | Base Gasket | \$6.25 | H241-00B20-H17 | | | | |
| | | | | | EX012031F | Exhaust Gasket | \$4.65 | 14181-16300 | | | | |
| | | | | | H0046043F | Head Gasket | \$21.76 | 11141-01C01-H17 | | | | |
| | | | | | PV022018AFM | Right Side Power Valve Gasket | \$3.80 | 11233-00B00-H17 | | | | |
| | | | | | Crank Seal Kit | | List Price | Component Part# | Component Part# | List Price | OEM Part# | |
| | | | | | C7701 | \$22.43 | OS175 | 35X52X8 Right Crank Seal | \$12.99 | 09283-36003 | | |
| | | | | | | | OS176 | 19X37X6 Left Crank Seal | \$11.87 | 09283-20046 | | |
| | | | | | Top End Kit | | List Price | Component Part# | Component Description | List Price | OEM Part # | |
| | | | | | C7062 | \$36.86 | H0046043F | Head Gasket | \$21.76 | 11141-01C01-H17 | | |
| | | | | | C7327 | \$36.86 | H0203043F | 74mm Bore Head Gasket | \$21.76 | | | |
| RM250 | 87-88 | 69 mm | C7062 | \$36.86 | B0048020F | Base Gasket | \$6.25 | 11241-00B20-H17 | | | | |
| | | | | | EX012031F | Exhaust Gasket | \$4.65 | 14181-16300 | | | | |
| | | 74 mm | | | IR004018AFM | Intake Gasket | \$3.80 | 14132-430 | | | | |
| | | | | | PV023020F | Center Power Valve Cover | \$3.80 | 11238-00B20 | | | | |
| | | C7327 | | | \$36.86 | PV024020F | Right Side Power Valve Gasket | \$3.80 | 11233-00B20-H17 | | | |
| | | | | | | Crank Seal Kit | | List Price | Component Part# | Component Part# | List Price | OEM Part# |
| | | | | | | C7701 | \$22.43 | OS175 | 35X52X8 Right Crank Seal | \$12.99 | 09283-36003 | |
| | | | | | | | | OS176 | 19X37X6 Left Crank Seal | \$11.87 | 09283-20046 | |
| | | | | | | Top End Kit | | List Price | Component Part# | Component Part# | List Price | OEM Part# |
| | | | | | | C7063 | \$33.17 | H0047043F | 68mm Bore Head Gasket | \$21.76 | 11141-28C10 | |
| C7328 | \$33.17 | | H0200043F | 73.5mm Bore Head Gasket | | \$21.76 | | | | | | |
| | | | B0049020F | Base Gasket | | \$6.25 | 11241-28C11 | | | | | |
| RM250 | 89-90 | 68 mm | C7063 | \$33.17 | B0049012F | High Comp. Base Gasket .012" | \$9.32 | | | | | |
| | | | | | IR011018AFM | Intake Gasket | \$3.48 | 3008-076/13156-01C10 | | | | |
| | | 73.5 mm | | | PV025018AFM | Center Power Valve Gasket | \$3.80 | 11238-28C00 | | | | |
| | | | | | PV026018AFM | Right Power Valve Gasket | \$3.80 | 11233-37E00 | | | | |
| | | C7328 | | | \$33.17 | R132V | Power Valve O-ring | \$1.19 | 09280-23002 | | | |
| | | | | | | EC233020F | Clutch Cover Gasket | \$9.94 | 11482-28C01 | | | |
| | | | | | | WP039018AFM | Water Pump Gasket | \$5.00 | 17431-28C00 | | | |
| | | | | | | Crank Seal Kit | | List Price | Component Part# | Component Part# | List Price | OEM Part# |
| | | | | | | C7701 | \$22.43 | OS175 | 35X52X8 Right Crank Seal | \$12.99 | 09283-20051 | |
| | | | | | | | | OS176 | 19X37X6 Left Crank Seal | \$11.87 | 09283-36007 | |
| Top End Kit | | | List Price | Component Part# | | Component Part# | List Price | OEM Part# | | | | |
| C7065 | \$38.33 | | R105X2B | Outer Head O-ring | | \$2.57 | 11148-28C20 | | | | | |
| RM250 | 91 | O-Ring | C7065 | \$38.33 | R75X2V | Inner Head O-ring | \$5.29 | 11147-28C20 | | | | |
| | | | | | B0049020F | Base Gasket | \$6.01 | 11241-28C11 | | | | |
| | | | | | B0049012F | High Comp. Base Gasket .012" | \$9.32 | | | | | |
| | | | | | IR011018AFM | Intake Gasket | \$3.48 | 3008-076/13156-01C10 | | | | |
| | | | | | PV025018AFM | Center Power Valve Gasket | \$3.80 | 11238-28C00 | | | | |
| | | | | | PV027018AFM | Right Side Power Valve 93-99 | \$3.80 | 11233-28C01 | | | | |
| | | | | | R132V | Power Valve O-ring | \$1.19 | 09280-23002 | | | | |
| | | | | | C7497 | Outer Clutch Cover Gasket | \$20.45 | 11484-28C10 | | | | |
| | | | | | Crank Seal Kit | | List Price | Component Part# | Component Part# | List Price | OEM Part# | |
| | | | | | C7703 | \$21.36 | OS178 | 35X52X8 Right Crank Oil Seal | \$12.99 | 09283-36007 | | |
| | | OS179 | 19X37X6 Left Crank Oil Seal | \$10.68 | 09283-20051 | | | | | | | |



MX/Dirt · Off-Road · ATV Gaskets



Cometic Gasket - An Exclusive NASCAR Performance® Product

SUZUKI

| Model | Year | Bore Size | Top End Kit | List Price | Component Part# | Component Description | List Price | OEM Part # | | | | |
|-------|-------|-----------------------------|-------------------|------------------------|-------------------------------------|---------------------------------|-----------------------------|---------------------------|------------------------|------------------------------|-------------------|-------------------|
| RM250 | 92-93 | O-Ring | C7123 | \$38.33 | R105X2B | Outer Head O-ring | \$2.57 | 11148-28C20 | | | | |
| | | | | | R75X2V | Inner Head O-ring | \$5.29 | 11147-28C20 | | | | |
| | | | | | B0050018AFM | Base Gasket | \$6.25 | 11241-28C11 | | | | |
| | | | | | B0050012F | High Comp. Base Gasket .012" | \$9.32 | | | | | |
| | | | | | IR011018AFM | Intake Gasket | \$3.48 | 3008-076/13156-01C10 | | | | |
| | | | | | PV025018AFM | Center Power Valve Gasket | \$3.80 | 11238-28C00 | | | | |
| | | | | | PV027018AFM | Right Side Power Valve 93-99 | \$3.80 | 11233-28C01 | | | | |
| | | | | | R132V | Power Valve O-ring | \$1.19 | 09280-23002 | | | | |
| | | | | | Bottom End Kit w/crank seals | List Price | Component Part# | Component Part# | List Price | OEM Part# | | |
| | | | | | C3365 | \$66.51 | EC231039F | Mag Cover Gasket | \$8.69 | 11483-28C01 | | |
| | | | | | | | EC233020F | Inner Clutch Cover Gasket | \$9.94 | 11482-28C01 | | |
| | | | | | | | EC272020F | Center Case Gasket | \$14.87 | 11481-28C00 | | |
| | | | | | | | WP049018AFM | 90-95 Water Pump Gasket | \$5.00 | 17431-28C10 | | |
| | | | | | | | C7497 | Outer Clutch Cover Gasket | \$20.45 | 11484-28C10 | | |
| | | Crank Seal Kit | List Price | Component Part# | Component Part# | List Price | OEM Part# | | | | | |
| | | C7703 | \$21.36 | OS178 | 35X52X8 Right Crank Oil Seal | \$12.99 | 09283-36007 | | | | | |
| | | | | OS179 | 19X37X6 Left Crank Oil Seal | \$10.68 | 09283-20051 | | | | | |
| RM250 | 94-95 | O-Ring | C7156 | \$38.33 | R105X2B | Outer Head O-ring | \$2.57 | 11148-28C20 | | | | |
| | | | | | R75X2V | Inner Head O-ring | \$5.29 | 11147-28C20 | | | | |
| | | | | | B0050018AFM | Base Gasket | \$6.25 | 11241-28C11 | | | | |
| | | | | | B0050012F | High Comp. Base Gasket .012" | \$9.32 | | | | | |
| | | | | | IR011018AFM | Intake Gasket | \$3.48 | 3008-076/13156-01C10 | | | | |
| | | | | | PV025018AFM | Center Power Valve Gasket | \$3.80 | 11238-28C00 | | | | |
| | | | | | PV027018AFM | Right Side Power Valve 93-99 | \$3.80 | 11233-28C01 | | | | |
| | | | | | R132V | Power Valve O-ring | \$1.19 | 09280-23002 | | | | |
| | | | | | Bottom End Kit w/crank seals | List Price | Component Part# | Component Part# | List Price | OEM Part# | | |
| | | | | | C3366 | \$69.63 | C7497 | Outer Clutch Cover Gasket | \$20.45 | 11484-28C10 | | |
| | | | | | | | EC271060AFM | Mag Cover Gasket | \$8.69 | 11483-28E10 | | |
| | | | | | | | EC273020F | Center Case Gasket | \$16.13 | 11481-28E10 | | |
| | | | | | | | EC297032AFM | Inner Clutch Cover Gasket | \$9.94 | 11482-28E10 | | |
| | | | | | | | WP049018AFM | 90-95 Water Pump Gasket | \$5.00 | 17431-28C10 | | |
| | | Clutch & Mag Kit | List Price | Component Part# | Component Description | List Price | OEM Part # | | | | | |
| | | C7156CM | \$29.14 | C7497 | Clutch Cover Gasket | \$20.45 | 11484-28C10 | | | | | |
| | | | | EC271060AFM | Mag Cover Gasket | \$8.69 | 11483-28E10 | | | | | |
| | | Crank Seal Kit | List Price | Component Part# | Component Part# | List Price | OEM Part# | | | | | |
| | | C7704 | \$23.50 | OS133 | 37X52X8 Right Crank Oil Seal | \$15.44 | 09283-38018 | | | | | |
| | | | | OS179 | 19X37X6 Left Crank Oil Seal | \$10.68 | 09283-20051 | | | | | |
| RM250 | 96-98 | O-Ring | C7280 | \$40.51 | R105X2B | Outer Head O-ring | \$2.57 | 11148-28C20 | | | | |
| | | | | | R75X2V | Inner Head O-ring | \$5.29 | 11147-28C20 | | | | |
| | | | | | B0237018AFM | Base Gasket | \$6.25 | 11241-37E00 | | | | |
| | | | | | B0237012F | Base Gasket High Comp. .012" | \$9.32 | | | | | |
| | | | | | IR107018AFM | Intake Gasket | \$7.44 | 13156-37E10 | | | | |
| | | | | | PV050018AFM | Right Power Valve Gasket | \$3.80 | 11233-37E00 | | | | |
| | | | | | PV051018AFM | Center Power Valve Cover Gasket | \$3.80 | 11238-37E00 | | | | |
| | | | | | Bottom End Kit w/crank seals | List Price | Component Part# | Component Part# | List Price | OEM Part# | | |
| | | | | | C3367 | \$62.35 | EC215020F | Center Case Gasket | \$16.13 | 11481-37E01 | | |
| | | | | | | | EC216032AFM | Inner Clutch Cover Gasket | \$9.94 | 11482-37E01 | | |
| | | | | | | | C7496 | Outer Clutch Cover Gasket | \$20.45 | 11484-37E00 | | |
| | | | | | | | EC218060AFM | Mag. Cover Gasket | \$8.69 | 11483-37E00 | | |
| | | | | | | | Clutch & Mag Kit | List Price | Component Part# | Component Description | List Price | OEM Part # |
| | | | | | | | C7280CM | \$29.14 | C7496 | Clutch Cover Gasket | \$20.45 | 11484-37E00 |
| | | | | EC218060AFM | Mag. Cover Gasket | \$8.69 | 11483-37E00 | | | | | |
| | | Crank Seal Kit | List Price | Component Part# | Component Part# | List Price | OEM Part# | | | | | |
| | | C7665 | \$20.29 | OS131 | 24X37X6 Left Crank Oil Seal | \$7.10 | 09283-25099 | | | | | |
| | | | | OS133 | 37X52X8 Right Crank Oil Seal | \$15.44 | 09283-38021 | | | | | |



MX/Dirt • Off-Road • ATV Gaskets



Cometic Gasket - An Exclusive NASCAR Performance® Product

SUZUKI

| Model | Year | Bore Size | Top End Kit | List Price | Component Part# | Component Description | List Price | OEM Part # |
|-------------------------|-----------------------|-----------------|--|-----------------------|-----------------|--|------------|-------------|
| RM250 | 99-00 | O-Ring | Top End Kit C7505 | \$44.69 | R105X2B | Outer Head O-ring | \$2.57 | 11148-28C20 |
| | | | | | R75X2V | Inner Head O-ring | \$5.29 | 11147-28C20 |
| | | | | | B0364018AFM | Base Gasket | \$7.44 | 11241-37E30 |
| | | | | | B0364012F | Base Gasket High Comp. .012" | \$9.94 | |
| | | | | | IR107018AFM | Intake Gasket | \$7.44 | 13156-37E10 |
| | | | | | PV061018AFM | Center Power Valve Cover | \$3.80 | 11238-36E00 |
| | | | | | PV079018AFM | Rt. Side Power Valve Cover | \$6.19 | 11233-37E30 |
| | | | | | PV081018AFM | Left Side Power Valve Gasket | \$5.00 | 11234-37E30 |
| | | | | | | | | |
| | | | Bottom End Kit w/crank seals C3368 | \$64.15 | EC216032AFM | Inner Clutch Cover Gasket | \$9.94 | 11482-37E01 |
| | | | | | C7496 | Outer Clutch Cover Gasket | \$20.45 | 11484-37E00 |
| | | | | | EC218060AFM | Mag Cover Gasket | \$8.69 | 11483-37E00 |
| | | | | | EC294020F | Center Case Gasket | \$18.56 | 11481-37E30 |
| | | | Clutch & Mag Kit C7280CM | List Price \$29.14 | Component Part# | Component Description | List Price | OEM Part # |
| | | | | | C7496 | Clutch Cover Gasket | \$20.45 | 11484-37E00 |
| EC218060AFM | Mag. Cover Gasket | \$8.69 | | | 11483-37E00 | | | |
| Crank Seal Kit C7665 | List Price \$20.29 | Component Part# | Component Part# | List Price | OEM Part# | | | |
| | | OS131 | 24X37X6 Left Crank Oil Seal | \$7.10 | 09283-25099 | | | |
| | | OS133 | 37X52X8 Right Crank Oil Seal | \$15.44 | 09283-38021 | | | |
| RM250 | 01-02 | O-Ring | Top End Kit C7779 | \$49.80 | R100X2B | Outer Head O-ring | \$3.64 | 11148-37F00 |
| | | | | | R73X2V | Inner Head O-ring | \$3.71 | 11147-37F00 |
| | | | | | B0495018AFM | Base Gasket | \$9.32 | 11241-37F01 |
| | | | | | B0495012F | High Comp. Base Gasket .012" | \$5.34 | |
| | | | | | IR107018AFM | Intake Gasket | \$7.44 | 13156-37E10 |
| | | | | | PV061018AFM | Center Power Valve Cover | \$3.80 | 11238-36E00 |
| | | | | | PV079018AFM | Right Side Power Valve Cover | \$6.19 | 11233-37E30 |
| | | | | | PV081018AFM | Left Side Power Valve Gasket | \$5.00 | 11234-37E31 |
| | | | | | C7496 | Outer Clutch Cover Gasket | \$20.45 | 11484-28C10 |
| | | | Bottom End Kit w/crank seals C3369 | List Price \$64.43 | EC218060AFM | Mag Cover Gasket | \$8.69 | 11483-37E00 |
| | | | | | EC500020F | Center Case Gasket | \$18.56 | 11481-37F00 |
| | | | | | EC501032AFM | Inner Clutch Cover Gasket | \$8.29 | 11482-37F00 |
| | | | | | WP122032AFM | Water Pump Gasket | \$1.71 | 17431-37F00 |
| | | | Clutch & Mag Kit C7280CM | List Price \$29.14 | Component Part# | Component Description | List Price | OEM Part # |
| | | | | | C7496 | Clutch Cover Gasket | \$20.45 | 11484-37E00 |
| EC218060AFM | Mag. Cover Gasket | \$8.69 | | | 11483-37E00 | | | |
| Crank Seal Kit C7665 | List Price \$20.29 | Component Part# | Component Part# | List Price | OEM Part# | | | |
| | | OS131 | 24X37X6 Left Crank Oil Seal | \$7.10 | 09283-25099 | | | |
| | | OS133 | 37X52X8 Right Crank Oil Seal | \$15.44 | 09283-38021 | | | |
| RM250 | 03-04 | O-Ring | Top End Kit C7467 | \$49.80 | R100X2B | Outer Head O-ring | \$3.64 | 11148-37F00 |
| | | | | | R73X2V | Inner Head O-ring | \$3.71 | 11147-37F00 |
| | | | | | B0632018AFM | Base Gasket | \$7.16 | 11241-37F20 |
| | | | | | B0632012F | High Comp. Base Gasket .012" | \$7.16 | |
| | | | | | PV116018AFM | Right Side Power Valve Gasket | \$3.80 | 11233-37F20 |
| | | | | | PV117018AFM | Left Side Power Valve Gasket | \$3.80 | 11234-37F20 |
| | | | | | PV118018AFM | Front Power Valve Gasket | \$3.80 | 11238-37F20 |
| | | | | | PV125018AFM | Power Valve Spring Gasket | \$2.44 | 11279-37F30 |
| | | | | | R44X3S | Expansion Chamber O-rings 2 Req.\$2.82 | \$4.17 | 14171-28C30 |
| | | | Bottom End Kit w/crank seals C3370 | List Price \$52.99 | Component Part# | Component Part# | List Price | OEM Part# |
| | | | | | C7496 | Outer Clutch Cover Gasket | \$20.45 | 11484-28C10 |
| | | | | | EC218060AFM | Mag Cover Gasket | \$8.69 | 11483-37E00 |
| | | | | | EC501032AFM | Inner Clutch Cover Gasket | \$8.29 | 11482-37F00 |
| | | | Clutch & Mag Kit C7280CM | List Price \$29.14 | Component Part# | Component Description | List Price | OEM Part # |
| | | | | | EC738020F | Center Case Gasket | \$3.35 | 11481-37F20 |
| WP122032AFM | Water Pump Gasket | \$1.71 | | | 17431-37F00 | | | |
| Crank Seal Kit C7665 | List Price \$20.29 | Component Part# | Component Part# | List Price | OEM Part# | | | |
| | | C7496 | Clutch Cover Gasket | \$20.45 | 11484-37E00 | | | |
| | | EC218060AFM | Mag. Cover Gasket | \$8.69 | 11483-37E00 | | | |
| Crank Seal Kit C7665 | List Price \$20.29 | Component Part# | Component Part# | List Price | OEM Part# | | | |
| | | OS131 | 24X37X6 Left Crank Oil Seal | \$7.10 | 09283-25099 | | | |
| | | OS133 | 37X52X8 Right Crank Oil Seal | \$15.44 | 09283-38021 | | | |



MX/Dirt · Off-Road · ATV Gaskets



Cometic Gasket - An Exclusive NASCAR Performance® Product

SUZUKI

| Model | Year | Bore Size | Top End Kit | List Price | Component Part# | Component Description | List Price | OEM Part # | | | | | |
|-------|-------|-----------|-----------------------------|-------------------|------------------------|--|-------------------|-------------------------------------|-------------------|------------------------|------------------------------|-------------------|-------------------|
| RM250 | 05-08 | O-Ring | C3099 | \$49.80 | R100X2B | Outer Head O-ring | \$3.64 | 11148-37F00 | | | | | |
| | | | | | R73X2V | Inner Head O-ring | \$3.71 | 11147-37F00 | | | | | |
| | | | | | B0632018AFM | Base Gasket | \$7.16 | 11241-37F20 | | | | | |
| | | | | | B0632012F | High Comp. Base Gasket .012" | \$7.16 | | | | | | |
| | | | | | EX640 | Exhaust Gasket | \$6.93 | 14172-28630 | | | | | |
| | | | | | R44X3S | Exp. O-rings 2 Req. | \$2.82 | 14171-28C30 | | | | | |
| | | | | | PV116018AFM | Right Side Power Valve Gasket | \$3.80 | 11233-37F20 | | | | | |
| | | | | | PV117018AFM | Left Side Power Valve Gasket | \$3.80 | 11234-37F20 | | | | | |
| | | | | | PV118018AFM | Front Power Valve Gasket | \$3.80 | 11238-37F20 | | | | | |
| | | | | | PV125018AFM | Power Valve Spring Gasket | \$2.44 | 11279-37F30 | | | | | |
| | | | | | | | | | | | | | |
| | | | | | | | | Bottom End Kit w/crank seals | List Price | Component Part# | Component Description | List Price | OEM Part # |
| | | | | | | | | C3371 | \$60.49 | C7496 | Outer Clutch Cover Gasket | \$20.45 | 11484-28C10 |
| | | | | | | | | | | EC218060AFM | Mag Cover Gasket | \$8.69 | 11483-37E00 |
| | | | | | | | | | | EC501032AFM | Inner Clutch Cover Gasket | \$8.29 | 11482-37F00 |
| | | | | | EC738020F | Center Case Gasket | \$3.35 | 11481-37F20 | | | | | |
| | | | | | R116B | Oil Fill Plug O-ring | \$1.13 | 09280-17003 | | | | | |
| | | | | | R20X2V | Counter Shaft O-ring | \$3.02 | 09280-20006 | | | | | |
| | | | | | WA124 | Water Pump Drain/ Trans. Oil Check Plug Washer 2 Req. | \$2.22 | 09168-06004 | | | | | |
| | | | | | WA125 | Drain Plug Washer | \$2.32 | 09168-12002 | | | | | |
| | | | | | WA126 | Power Valve Seal Crush Washer | \$0.80 | 09168-08015 | | | | | |
| | | | | | WP122032AFM | Water Pump Gasket | \$1.71 | 17431-37F00 | | | | | |
| | | | Clutch & Mag Kit | List Price | Component Part# | Component Description | List Price | OEM Part # | | | | | |
| | | | C7280CM | \$29.14 | C7496 | Clutch Cover Gasket | \$20.45 | 11484-37E00 | | | | | |
| | | | | | EC218060AFM | Mag. Cover Gasket | \$8.69 | 11483-37E00 | | | | | |
| | | | Crank Seal Kit | List Price | Component Part# | Component Description | List Price | OEM Part # | | | | | |
| | | | C3372 | \$21.37 | OS131 | 24X37X7 Left Crank Seal | \$7.10 | 09283-25099 | | | | | |
| | | | | | OS132 | 29X40X7 Right Crank Seal | \$16.64 | 09283-28025 | | | | | |

RMX250

| Model | Year | Bore Size | Top End Kit | List Price | Component Part# | Component Description | List Price | OEM Part # | | | |
|--------|-------|-----------|-------------|---------------------|-----------------|--------------------------------|------------|------------------------|------------------------|-------------------|------------------|
| RMX250 | 89-92 | 68 mm | C7257 | \$38.33 | B0049020F | Base Gasket | \$6.25 | 11241-28C11 | | | |
| | | | | | H0313059F | Head Gasket | \$24.75 | 1141-05D00 | | | |
| | | | | | IR011018AFM | ntake Gasket | \$3.48 | 3008-076/13156-01C10 | | | |
| | | | | | PV025018AFM | Center Power Valve Gasket | \$3.80 | 11238-28C00 | | | |
| | | | | | PV026018AFM | Right Power Valve Gasket | \$3.80 | 11233-37E00 | | | |
| | | | | | R134V | Expansion Chamber O-ring | \$3.92 | 14171-28C01 | | | |
| | | | | | | | | | | | |
| | | | | | | | | Component Part# | Component Part# | List Price | OEM Part# |
| | | | | | | | | C7496 | Clutch Cover Gasket | \$20.45 | 11484-28C10 |
| | | | | | | | | | | | |
| RMX250 | 93-99 | 68 mm | C7258 | \$38.33 | B0050018AFM | Base Gasket | \$6.25 | 11241-28C11 | | | |
| | | | | | B0050012F | High Compression Base Gasket | \$9.32 | 11241-28C11 | | | |
| | | | | | H0313059F | Head Gasket | \$24.75 | 1141-05D00 | | | |
| | | | | | IR011018AFM | Intake Gasket | \$3.48 | 3008-076/13156-01C10 | | | |
| | | | | | PV025018AFM | Center Power Valve Gasket | \$3.80 | 11238-28C00 | | | |
| | | | | | PV026018AFM | Right Power Valve Gasket 93-95 | \$3.80 | 11233-37E00 | | | |
| | | | | | PV027018AFM | 96-99 Right Power Valve Gasket | \$3.80 | 11233-28C01 | | | |
| | | | | | R132V | Power Valve O-ring | \$1.19 | 09280-23002 | | | |
| | | | | | | | | | | | |
| | | | | | | | | Component Part# | Component Part# | List Price | OEM Part# |
| | | | C7496 | Clutch Cover Gasket | \$20.45 | 11484-28C10 | | | | | |

DR-Z250

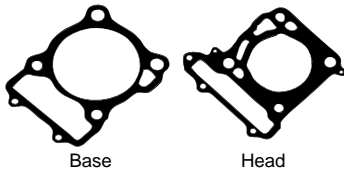

| Model | Year | Bore Size | Top End Kit | List Price | Component Part# | Component Description | List Price | OEM Part # |
|---------|-------|-----------|-------------|------------|-----------------|-----------------------|------------|-------------|
| DR-Z250 | 03-07 | 73 mm | C7968 | \$36.99 | H1694027S | Head Gasket 73mm Bore | \$30.95 | 11141-13E00 |
| | | 80 mm | C7969 | \$36.99 | H1552027S | Head Gasket 80mm Bore | \$30.95 | |
| | | | | | B0680020F | Base Gasket | \$8.69 | 11241-13E02 |



MX/Dirt · Off-Road · ATV Gaskets



Cometic Gasket - An Exclusive NASCAR Performance® Product

RM-Z250

| Model | Year | Bore Size | EST | List Price | Component Part# | Component Description | List Price | OEM Part # | | | |
|-----------------------------|-------|-----------------------------------|-------------------|------------|------------------------|------------------------------------|---------------------|-----------------------|------------------------------|---------|-------------|
| RM-Z250 | 04-06 | 77 mm | C3174-EST | \$74.99 | H2169SP1027S | Head Gasket 77mm | \$43.39 | K1100-40003 | | | |
| | | 78 mm | C3054-EST | \$74.99 | H2096027S | Head Gasket 78mm Bore | \$43.39 | | | | |
| | | 80 mm | C3056-EST | \$74.99 | H2169027S | Head Gasket 80mm Bore | \$43.39 | | | | |
| | | 81mm | C7221-EST | \$74.99 | H1967027S | Head Gasket 81mm Bore | \$43.39 | | | | |
| | | 83 mm | C3135-EST | \$74.99 | H2471SP1027S | Head Gasket 83mm Bore | \$43.39 | | | | |
| | | 84 mm | C3118-EST | \$74.99 | H2471027S | Head Gasket 84mm Bore | \$43.39 | | | | |
| | | | | | B0691014RC | Base Gasket | \$20.99 | | K1106-10025 | | |
| | | | | | 3233V | Valve Seals | \$5.11 ea. | | K9204-91349 | | |
| | | | | | R018B | Cam Chain Tensioner O-ring | \$3.92 | | KK920-55086 | | |
| | | | | | EX651 | Exhaust Gasket | \$8.98 | | 14181-49H00 | | |
| | | Bottom End Kit w/Oil Seals | | | | | | | | | |
| | | | | | C3174BE | \$98.69 | WA108 | | Crank Case Drain Plug Washer | \$2.56 | 92065-058 |
| | | | | | | | R118B | | Crank End Cap O-Ring | \$1.13 | 670B2022 |
| | | | | | EC903032AFM | Inner Clutch Cover Gasket | \$20.99 | 11061-0030 | | | |
| | | | | | R112B | Timing Mark Plug O-Ring | \$3.92 | 92055-1141 | | | |
| | | | | | R117B | Crank Case Oil Fill O-Ring | \$0.42 | 92055-1146 | | | |
| | | | | | R018B | Output Shaft O-Ring (2) | \$3.92 | 92055-055 | | | |
| | | | | | MR042 | Water Pump Cover O-Ring | \$3.40 | 92055-0010 | | | |
| | | | | | R116B | Water Pipe O-Ring | \$1.13 | 92055-1308 | | | |
| Oil Seal Kit | | | List Price | | Component Part# | Component Description | List Price # | OEM Part # | | | |
| | | | C3174OS | \$45.36 | OS227 | Oil Pump Seal 12x22x5 | \$2.67 | 92049-1519 | | | |
| | | | | | OS279 | Decomp. Shaft Seal 10x18x5 | \$1.48 | 92049-1196 | | | |
| | | | | | OS295 | Crank Seal 30x40x7 | \$9.89 | 92049-1556/92049-0030 | | | |
| | | | | | OS305 | Shift Shaft Seal 14x22x6 | \$5.77 | 92049-0015 | | | |
| | | | | | OS306 | Clutch Actuator Shaft Seal 12x18x4 | \$2.91 | 92049-1262 | | | |
| | | | | | OS307 | Start Shaft Seal 18x30x7 | \$7.03 | 92049-013/92049-007 | | | |
| | | | | | OS308 | Impeller Seal 8x22x7/7.5 | \$5.89 | 92049-0021/92049-0061 | | | |
| | | | | | OS309 | Inner WP Seal 8x22x5 | \$5.89 | 92049-0016/92049-0060 | | | |
| | | | | | OS359 | Output Shaft Seal 25x40x6 | \$3.83 | 92049-1478 | | | |
| Clutch & Mag Kit | | | List Price | | Component Part# | Component Description | List Price | OEM Part # | | | |
| | | | C3174CM | \$24.80 | EC847060AFM | Clutch Cover Gasket | \$11.18 | K1106-10031 | | | |
| | | | | | EC904032AFM | Mag Cover Gasket | \$13.62 | K1106-10032 | | | |
| RM-Z250 | 07-09 | 77 mm | C3175-EST | \$61.31 | H2617SP2027S | Head Gasket 77mm Bore | \$31.15 | 11141-10H00 | | | |
| | | 78 mm | C3176-EST | \$61.31 | H2617027S | Head Gasket 78mm Bore | \$31.15 | | | | |
| | | 79 mm | C3177-EST | \$61.31 | H2617SP1027S | Head Gasket 79mm Bore | \$31.15 | | | | |
| | | 81 mm | C3203-EST | \$61.31 | H2617SP7027S | Head Gasket 81mm Bore | \$31.15 | | | | |
| | | 83 mm | C3278-EST | \$61.31 | H2617SP8027S | Head Gasket 83mm Bore | \$31.15 | | | | |
| | | | | | B0884010RC | Base Gasket | \$13.47 | | 11241-10H00 | | |
| | | | | | EX651 | Exhaust Gasket | \$8.98 | | 14181-49H00 | | |
| | | | | | R018B | Cam Chain Tensioner Gasket | \$3.92 | | 09280-19001 | | |
| | | | | | WA114 | Cam Chain Tensioner Bolt | \$3.02 | | 12837-27F10 | | |
| | | | | | 3251V | Valve Seals | \$1.48 | | 09289-04002 | | |
| | | Bottom End Kit w/Oil Seals | | | | | | | | | |
| | | | | | C3175BE | \$98.69 | EC1148020F | | Center Case Gasket | \$20.22 | 11481-10H00 |
| | | | | | | | WA125 | | Drain Plug Gasket | \$2.23 | 09168-12002 |
| | | | | | WA124 | Crank Sensor Gasket | \$2.22 | 09168-06004 | | | |
| | | | | | R116B | Fill Plug O-ring | \$1.13 | 09280-17003 | | | |
| | | | | | EC1150032AFM | Inner Clutch Cover Gasket | \$20.22 | 11482-10H00 | | | |
| | | | | | R119B | Crank End Cap O-Ring | \$1.04 | 09280-22008 | | | |
| | | | | | R10X2V | Timing Mark Plug O-Ring | \$1.59 | 09280-10016 | | | |
| | | | | | R20X2V | Output Shaft O-rings | \$3.02 | 09280-20006 | | | |
| | | | | | R029B | Oil Filter O-Ring | \$1.13 | 09280-39001 | | | |
| Oil Seal Kit | | | List Price | | Component Part# | Component Description | List Price # | OEM Part # | | | |
| | | | C3174OS | \$48.51 | WA124 | Clutch Drain Plug Gasket | \$2.22 | 09168-06004 | | | |
| | | | | | R16X2V | Oil Screen O-ring 16x22x2 | \$3.02 | 09168-16003 | | | |
| | | | | | OS132 | Right Crank Seal 30x40x7 | \$16.64 | 09283-30061 | | | |
| | | | | | OS218 | Shift Shaft Seal 14x22x6 | \$4.74 | 09283-14006 | | | |
| | | | | | OS370 | Inner WP Seal | \$10.11 | 09282-12012 | | | |
| | | | | | OS216 | Impeller Seal | \$5.54 | 17461-37F00 | | | |
| | | | | | OS367 | Output Shaft Seal | \$6.76 | 09289-28012 | | | |
| | | | | | OS172 | Start Shaft Seal | \$4.72 | 09283-18004 | | | |
| Clutch & Mag Kit | | | List Price | | Component Part# | Component Description | List Price | OEM Part # | | | |
| | | | C3175CM | \$21.34 | EC1154032AFM | Mag Cover Gasket | \$9.47 | 11483-10H00 | | | |
| | | | | | EC1153032AFM | Clutch Cover Gasket | \$11.87 | 11484-10H00 | | | |



MX/Dirt · Off-Road · ATV Gaskets



Cometic Gasket - An Exclusive NASCAR Performance® Product

SUZUKI

| Model | Year | Bore Size | EST Top End Kit | List Price | Component Part# | Component Description | List Price | OEM Part # | | |
|---------|-------|-----------|-----------------------------|-------------------|---|------------------------------|-----------------------------|---------------------------|-------------------|--------------|
| RM-Z250 | 10-14 | 77 mm | C3406-EST | \$57.10 | H3139027S | Head Gasket 77 mm Bore | \$31.15 | 11141-49H00 | | |
| | | 79 mm | C3407-EST | \$57.10 | H3139SP1027S | Head Gasket 79 mm Bore | \$31.15 | 11141-49H00 | | |
| | | 80 mm | C3408-EST | \$57.10 | H3139SP2027S | Head Gasket 80 mm Bore | \$31.15 | 11141-49H00 | | |
| | | 82 mm | C3409-EST | \$57.10 | H3139SP3027S | Head Gasket 82 mm Bore | \$31.15 | 11141-49H00 | | |
| | | 84 mm | C3410-EST | \$57.10 | H3139SP5027S | Head Gasket 84 mm Bore | \$31.15 | 11141-49H00 | | |
| | | | | | | 3251V | Valve Stem Seals 4 Required | \$1.48 | 09289-04002 | |
| | | | | | | B1032010RC | Base Gasket | \$13.47 | 11241-49H00 | |
| | | | | | | EX651 | Exhaust Gasket | \$8.98 | 14181-49H00 | |
| | | | | | | OS020 | Head Drain Seal | \$1.03 | 09168-06023 | |
| | | | | | | R013V | Water Temp Sensor O-ring | \$1.08 | 13655-14G00 | |
| | | | | | | R019V | Cam Chain Tensioner O-ring | \$0.57 | | |
| | | | | | | R122V | Cam Tower O-ring Seal | \$1.25 | 09280-26007 | |
| | | | | | Bottom End Kit w/o crank seals | List Price | Component Part# | Component Part# | List Price | OEM # |
| | | | | | C3443 | \$49.42 | EC1153032AFM | Clutch Cover Gasket | \$11.87 | 11484-10H00 |
| | | | | | | | EC1150032AFM | Inner Clutch Cover Gasket | \$20.22 | 11482-10H00 |
| | | | | | EC1633032AFM | Mag Cover Gasket | \$9.47 | 11483-49H00 | | |
| | | | | | EC1632020F | Center Case Gasket | \$20.22 | | | |
| | | | Clutch & Mag Kit | List Price | Component Part# | Component Description | List Price | OEM Part # | | |
| | | | C3406CM | \$21.34 | EC1153032AFM | Clutch Cover Gasket | \$11.87 | 11484-10H00 | | |
| | | | | | EC1633032AFM | Mag Cover Gasket | \$9.47 | 11483-49H00 | | |

DR350



Base



Head

| Model | Year | Bore Size | Top End Kit | List Price | Component Part# | Component Description | List Price | OEM Part # |
|-------|-------|-----------|-------------|------------|-----------------|-----------------------|-------------|-------------|
| DR350 | 90-99 | 80 mm | C7068 | \$29.35 | H0244043F | Head Gasket 80mm Bore | \$33.22 | 11141-14D01 |
| | | 82 mm | C7157 | \$29.35 | H0049043F | Head Gasket 82mm Bore | \$33.22 | |
| | | 88 mm | C7263 | \$29.35 | H0222043F | Head Gasket 88mm Bore | \$33.22 | |
| | | 91 mm | C7264 | \$29.35 | H0229043F | Head Gasket 91mm Bore | \$33.22 | |
| | | | | | | B0052020F | Base Gasket | \$6.25 |

DR-Z400

| Model | Year | Bore Size | EST Top End Kit | List Price | Component Part# | Component Description | List Price | OEM Part # | |
|---------|-------|-----------|--------------------|-------------|---------------------|------------------------|------------------------------|-------------------|------------------|
| DR-Z400 | 00-13 | 92 mm | C7688-EST | \$64.23 | H0949027S | Head Gasket | \$30.95 | 11141-29F01 | |
| | | 94 mm | C7806-EST | \$64.23 | H1045027S | Head Gasket 94mm Bore | \$30.95 | | |
| | | 95 mm | C7963-EST | \$64.23 | H1699027S | Head Gasket 95mm Bore | \$30.95 | | |
| | | 97 mm | C7980-EST | \$64.23 | H1046027S | Head Gasket 97mm Bore | \$30.95 | | |
| | | | | | | B0440010RC | Base Gasket | \$8.69 | 11241-29F00 |
| | | | | | | EX243 | Exhaust Gasket 2 Req. | \$2.79 | 14181-29E02 |
| | | | | | | EC377032AFM | Cam Chain Tensioner Gasket | \$3.35 | 12837-24A10 |
| | | | | | | WA121 | Cam Chain Tensioner Washer | \$0.80 | 09168-06023 |
| | | | | | | 3160V | Valve Seals | \$5.50 | 09289-05011 |
| | | | | | | Component Part# | Component Description | List Price | OEM Part# |
| | | | | EC837032AFM | Clutch Cover Gasket | \$13.29 | 11484-29F00 | | |

DR-Z400SM

| Model | Year | Bore Size | EST Top End Kit | List Price | Component Part# | Component Description | List Price | OEM Part # | |
|--------------|-------|-----------|--------------------|------------|-----------------|------------------------|------------------------------|-------------------|-------------------|
| DRZ400 SM | 05-13 | 92 mm | C7978-EST | \$64.23 | H0949027S | Head Gasket 92mm Bore | \$30.95 | 11141-29F01 | |
| | | 94 mm | C7979-EST | \$64.23 | H1045027S | Head Gasket 94mm Bore | \$30.95 | | |
| | | 97 mm | C7980-EST | \$64.23 | H1046027S | Head Gasket 97mm Bore | \$30.95 | | |
| | | | | | | B0440027S | Base Gasket | \$28.51 | 11241-29F11 |
| | | | | | | EX243 | Exhaust Gasket 2 Req. | \$2.79 | 14181-29E02 |
| | | | | | | EC377032AFM | Cam Chain Tensioner Gasket | \$3.35 | 12837-24A10 |
| | | | | | | 3160V | Valve Seals 4 Req. | \$5.50 | 09289-05011 |
| | | | | | | WA121 | Cam Chain Tensioner Washer | \$0.80 | 09168-06023 |
| | | | | | | Component Part# | Component Description | List Price | OEM Part # |
| | | | | | | EC837032AFM | Clutch Cover Gasket | \$13.29 | 11484-29F00 |

All Component Parts can be purchased individually.



MX/Dirt • Off-Road • ATV Gaskets



Cometic Gasket - An Exclusive NASCAR Performance® Product

LT-R450

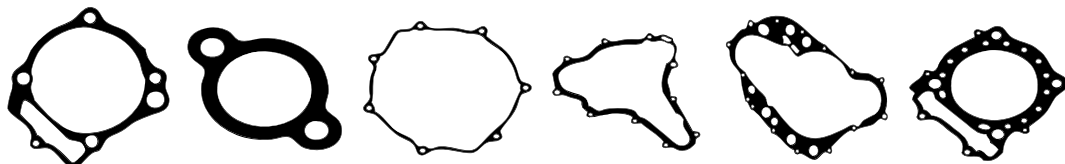

Base Timing Chain Tensioner Outer Clutch Cover Mag Cover Inner Clutch Cover Head

| Model | Year | Bore Size | EST | List Price | Component Part# | Component Description | List Price | OEM Part # | |
|---------|-------|-----------|---------------------------------------|------------|-----------------|---------------------------|------------|-------------|-------------|
| | | | Top End Kit | | | | | | |
| LT-R450 | 06-09 | 96mm | C3208-EST | \$54.99 | H2499SP5027S | Head Gasket | \$31.15 | 11141-45G00 | |
| | | 97mm | C3150-EST | \$54.99 | H2499027S | Head Gasket 97mm Bore | \$31.15 | | |
| | | 98mm | C3157-EST | \$54.99 | H2499SP2027S | Head Gasket 98mm Bore | \$31.15 | | |
| | | 101mm | C3158-EST | \$54.99 | H2499SP1027S | Head Gasket 101mm Bore | \$31.15 | | |
| | | | | | B0857010RC | Base Gasket | \$11.87 | | 11241-45G00 |
| | | | | | EX877 | Exhaust Gasket | \$7.56 | | 14181-35G00 |
| | | | Bottom End Kit w/o crank seals | | | | | | |
| | | | C3378 | \$71.32 | EC1119018AFM | Clutch Cover | \$11.87 | 11484-45G00 | |
| | | | | | EC1120032AFM | Mag Cover Gasket | \$17.84 | 11483-45G00 | |
| | | | | | EC1121032AFM | Inner Clutch Cover Gasket | \$28.57 | 11482-45G00 | |
| | | | | | R138SB | Oil Filter O-ring | \$5.71 | 0928-54001 | |
| | | | | | R32X3V | Crank End O-ring | \$3.57 | 09280-33004 | |
| | | | Clutch & Mag Kit | | | | | | |
| | | | C3408CM | \$29.71 | EC1119018AFM | Clutch Cover | \$11.87 | 11484-45G00 | |
| | | | | | EC1120032AFM | Mag Cover Gasket | \$17.84 | 11483-45G00 | |

RM-Z450

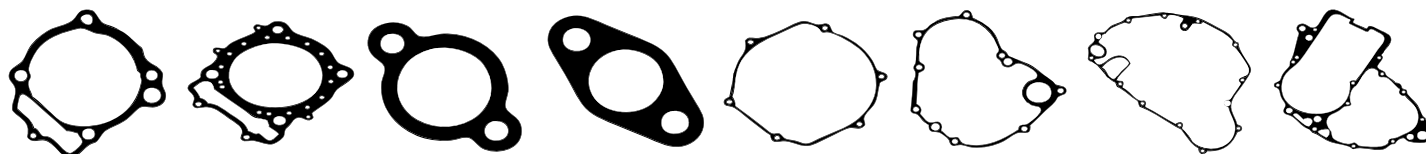

Base Head Cam Chain Tensioner Timing Chain Outer Clutch Cover Mag Cover Inner Clutch Cover Center Case

| Model | Year | Bore Size | EST | List Price | Component Part# | Component Description | List Price | OEM Part # | |
|---------|-------|-----------|-----------------------------------|------------|-----------------|----------------------------|------------|-------------|-------------|
| | | | Top End Kit | | | | | | |
| RM-Z450 | 05-07 | 95.5 mm | C3102-EST | \$86.99 | H2393030S | Head Gasket | \$31.99 | 11141-35G01 | |
| | | 97.5 mm | C3104-EST | \$86.99 | H2393SP1030S | 97.5mm Bore Head Gasket | \$31.99 | | |
| | | 98 mm | C3127-EST | \$86.99 | H2393SP3030S | 98mm Bore Head Gasket | \$31.99 | | |
| | | | | | B0816010S | Base Gasket | \$16.69 | | 11241-35G00 |
| | | | | | EX877 | Exhaust Gasket | \$7.56 | | 14172-28630 |
| | | | | | EC1017032AFM | Cam Chain Tensioner Gasket | \$3.12 | | 12837-32410 |
| | | | Bottom End Kit w/Oil Seals | | | | | | |
| | | | C3102BE | \$133.37 | WA140 | Water Pump Drain Washer | \$0.63 | 09168-06018 | |
| | | | | | R10X2V | Timing Plug O-ring | \$1.59 | 09280-10016 | |
| | | | | | R116B | Fill Plug O-ring | \$1.13 | 09280-17003 | |
| | | | | | R020V | Output Shaft O-ring | \$1.19 | 09280-21010 | |
| | | | | | R119B | Crank End Cap O-Ring | \$1.04 | 09280-22008 | |
| | | | | | R029B | Oil Filter O-Ring | \$1.13 | 09280-39001 | |
| | | | | | EC1021020RC | Center Case Gasket | \$26.18 | 11481-35G11 | |
| | | | | | EC1020032AFM | Inner Clutch Cover Gasket | \$26.18 | 11482-35G10 | |
| | | | | | MR043 | Water Pump Cover O-Ring | \$10.09 | 17431-35G10 | |
| | | | Oil Seal Kit | | | | | | |
| | | | C3102OS | \$51.46 | OS370 | Inner WP Seal | \$10.11 | 09282-12012 | |
| | | | | | OS218 | Shift Shaft Seal 14x22x6 | \$4.74 | 09283-14006 | |
| | | | | | OS249 | Start Shaft Seal | \$3.83 | 09283-20031 | |
| | | | | | OS132 | Right Crank Seal | \$16.64 | 09283-30061 | |
| | | | | | OS219 | Clutch Actuator Seal | \$2.69 | 09285-10004 | |
| | | | | | OS338 | Output Shaft Seal | \$7.90 | 09289-31002 | |
| | | | | | OS216 | Impeller Seal | \$5.54 | 17461-37F00 | |
| | | | | | OS371 | Decomp. Shaft Seal 10x17x6 | \$4.74 | 09282-10014 | |
| | | | Clutch & Mag Kit | | | | | | |
| | | | C3102CM | \$27.55 | EC1018032AFM | Outer Clutch Cover Gasket | \$17.38 | 11484-35G10 | |
| | | | | | EC1019032AFM | Mag Cover Gasket | \$10.17 | 11483-35G10 | |



MX/Dirt · Off-Road · ATV Gaskets



Cometic Gasket - An Exclusive NASCAR Performance® Product

SUZUKI

| Model | Year | Bore Size | EST Top End Kit | List Price | Component Part# | Component Description | List Price | OEM Part # |
|-----------------------------|-----------------------|-----------|--------------------|------------|------------------------|---|---------------------|-------------------|
| RM-Z450 | 08-15 | 97mm | C3233-EST | \$73.48 | H2784027S | 97mm Bore Head Gasket | \$31.99 | 11141-28H00 |
| | | 99mm | C3234-EST | \$73.48 | H2784SP1027S | 99mm Bore Head Gasket | \$31.99 | |
| | | 101mm | C3235-EST | \$73.48 | H2784SP2027S | 101mm Bore Head Gasket | \$31.99 | |
| | | | | | B0943018S | Base Gasket | \$21.18 | 11241-28H00 |
| | | | | | EX877 | Exhaust Gasket | \$7.56 | 14181-35G00 |
| | | | | | EC440032AFM | Cam Chain Tensioner Gasket | \$14.71 | 12837-24A10 |
| | | | | | 3238V | Valve Seals 4 Req. | \$1.36 ea. | 09289-05015 |
| | Bottom End Kit | | | | Component Part# | Component Description | List Price # | OEM Part # |
| | w/Oil Seals | | | | | | | |
| | | | | C3233BE | \$132.75 | R116B | Fill Plug O-Ring | \$1.13 |
| | | | | | R22X2V | Sprocket Spacer O-ring 1.9, ID:21.8 | 2.66 | 09280-21010 |
| | | | | | R22X2V | Crank End Plug O-ring | 2.66 | 09280-22008 |
| | | | | | WA116 | Drain Plug Gasket | 1.06 | 09168-08016 |
| | | | | | R029B | Oil Filter Cover O-ring D:2.0, ID:38.5 | 1.13 | 09280-39001 |
| | | | | | R16X2V | Oil Screen O-ring 16x22x2 | 3.02 | 09168-16003 |
| | | | | | WP470 | Water Pump Cover O-Ring | 10.27 | 17431-28H00 |
| | | | | | R122V | Neutral Safety Switch O-ring | 1.25 | 09280-26005 |
| | | | | | R9X2V | Oil Pump Dowel O-ring | 1.59 | 09280-09005 |
| | | | | | R007V | Oil Pump Nozzle O-ring 4x1.2 | 0.63 | 09280-05007 |
| | | | | | EC1250020RC | Center Case Gasket | 22.66 | 11481-28H00 |
| | | | | | EC1251032AFM | Inner Clutch Cover Gasket | 21.53 | 11482-28H00 |
| Oil Seal Kit | | | List Price | | Component Part# | Component Description | List Price # | OEM Part # |
| | | | C3233OS | \$58.95 | OS132 | Right Crank Seal 30x40x7 | \$16.64 | 09283-30061 |
| | | | | | OS216 | Water Pump Oil seal | 5.54 | 17461-37F00 |
| | | | | | OS338 | Output Shaft Oil Seal 31x4 | \$7.90 | 09289-31003 |
| | | | | | OS249 | Start Shaft Oil Seal 20x27x5 | \$3.83 | 09283-20031 |
| | | | | | OS305 | Shift Shaft Seal 14x22x6 | 5.77 | 09283-14006 |
| | | | | | OS370 | Water Pump Seal | 10.11 | 09282-12012 |
| | | | | | OS372 | Left Crank Seal 32x47x6 | 13.89 | 09283-32037 |
| Clutch & Mag Kit | | | List Price | | Component Part# | Component Description | List Price | OEM Part # |
| | | | C3233CM | \$26.58 | EC1249032AFM | Clutch Cover Gasket | \$14.71 | 11484-28H00 |
| | | | | | EC1252032AFM | Mag Cover Gasket | \$11.87 | 11483-28H00 |

LT500

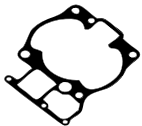

Base

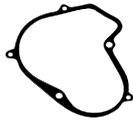

Left Engine Cover



Head

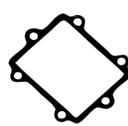

Intake

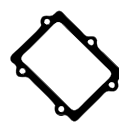

Intake

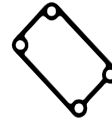

Power Valve

| Model | Year | Bore Size | Top End Kit | List Price | Component Part# | Component Description | List Price | OEM Part # | |
|-----------------------|-----------------------|-----------|-------------------|------------------------|------------------------|-------------------------------|---------------------|----------------------|-------------|
| LT500 H | 87 | 88 mm | C7072 | \$33.35 | H0052043F | 88mm Bore Head Gasket | \$22.32 | 11141-43B01 | |
| | | 89.5 mm | C7273 | \$33.35 | H0315043F | 89.5mm Bore Head Gasket | \$22.32 | | |
| | | 91 mm | C7125 | \$33.35 | H0054043F | 91mm Bore Head Gasket | \$22.32 | | |
| | | | | | B0054020F | Base Gasket | \$7.16 | 11241-43B00 | |
| | | | | | IR176020F | Intake Gasket 87 Model Only | \$3.80 | | |
| | | | | | PV022018AFM | Right Side Power Valve Cover | \$3.80 | 11233-00B00-H17 | |
| | Bottom End Kit | | | List Price | Component Part# | Component Part# | List Price | OEM # | |
| | w/crank seals | | | | | | | | |
| | | | | C3380 | \$36.26 | C7718 | Clutch Cover Gasket | \$11.47 | 11482-43B00 |
| | | | | EC321020F | | Mag Cover Gasket | \$8.29 | 11483-43B00 | |
| Crank Seal Kit | | | List Price | Component Part# | Component Part# | List Price | OEM # | | |
| | | | C7677 | \$23.50 | OS131 | 24X37X6 Left Crank Oil Seal | \$7.10 | 09283-25099 | |
| | | | | | OS133 | 37X52X8 Right Crank Oil Seal | \$15.44 | 09283-38021 | |
| LT500 | 88-90 | 88 mm | C7073 | \$33.35 | H0053043F | 88mm Bore Head Gasket | \$22.32 | 11111-43B10 | |
| | | 89.5 mm | C7274 | \$33.35 | H0316043F | 89.5mm Bore Head Gasket | \$22.32 | | |
| | | 91 mm | C7122 | \$33.35 | H0055043F | 91mm Bore Head Gasket | \$22.32 | | |
| | | | | | B0054020F | Base Gasket | \$7.16 | 11241-43B10 | |
| | | | | | IR011018AFM | Intake Gasket | \$3.48 | 3008-076/13156-01C10 | |
| | | | | | PV022018AFM | Right Side Power Valve Cover | \$3.80 | 11233-00B00-H17 | |
| | Bottom End Kit | | | List Price | Component Part# | Component Part# | List Price | OEM # | |
| | w/crank seals | | | | | | | | |
| | | | | C3380 | \$36.26 | C7718 | Clutch Cover Gasket | \$11.47 | 11482-43B00 |
| | | | | | | EC321020F | Mag Cover Gasket | \$8.29 | 11483-43B00 |
| Crank Seal Kit | | | List Price | Component Part# | Component Part# | List Price | OEM Part# | | |
| | | | C7675 | \$16.85 | OS145 | 35X52X8 Left Side Crank Seal | \$9.47 | 09283-36004 | |
| | | | | | OS146 | 24X38X7 Right Side Crank Seal | \$9.26 | 09283-25082 | |

All Component Parts can be purchased individually.



MX/Dirt • Off-Road • ATV Gaskets



Cometic Gasket - An Exclusive NASCAR Performance® Product

DR650

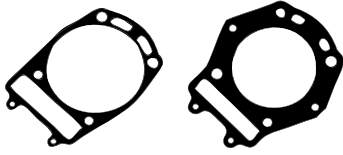

| Model | Year | Bore Size | Top End Kit | List Price | Component Part# | Component Description | List Price | OEM Part # |
|-------|-------|-----------|-------------|------------|-----------------|-----------------------|------------|-------------|
| DR650 | 95-10 | 103 mm | C7335 | \$29.35 | H0460043F | Head Gasket | \$30.95 | 11141-12D00 |
| | | | | | B0273020F | Base Gasket | \$6.25 | 11241-32E00 |

LTZ-A700



| Model | Year | Bore Size | Top End Kit | List Price | Component Part# | Component Description | List Price | OEM Part # |
|----------|-------|-----------|-------------|------------|-----------------|--|------------|-------------|
| LTZ-A700 | 05-07 | 106mm | C3128-EST | \$42.36 | H2424027S | Head Gasket | \$24.99 | 11141-31G00 |
| KingQuad | | | | | B0821010RC | Base Gasket | \$9.88 | 11241-31G00 |
| | | | | | EC1044018AFM | Cam Chain Tensioner Gasket | \$1.81 | 12837-19B10 |
| | | | | | 3238V | Valve Seals 4 Req. | \$1.36 ea. | 09289-05015 |
| | | | | | R12.5X2.5V | Thermostat O-ring/Water Line O-ring 2 Req. | \$4.09 | 09168-12017 |
| | | | | | R7X2V | Cam Chain Tensioner O-ring | \$2.16 | 09168-26001 |

YAMAHA

| Model | Year | Bore Size | Top End Kit | List Price | Component Part# | Component Description | List Price | OEM Part # |
|-------|-------|-----------|-------------|------------|-----------------|-----------------------|------------|-----------------|
| PW50 | 81-05 | 42 mm | C7266 | \$21.99 | H0309010C | Head Gasket | \$17.15 | 517-11181-01-00 |
| | | | | | B0185018AFM | Base Gasket | \$4.65 | 3PT-11351-00 |
| YSR50 | 87-92 | 46 mm | C7075 | \$21.99 | H0057010C | Head Gasket | \$17.15 | 5G6-11181-00-00 |
| | | | | | B0057018AFM | Base Gasket | \$5.05 | 3T2-11351-00-00 |
| PW80 | 83-01 | 50 mm | C7251 | \$26.46 | H0310010C | Head Gasket | \$17.15 | 1W7-11181-00-00 |
| | | | | | B0186018AFM | BaseGasket | \$4.65 | 4AW-11351-00 |

YFM80 RAPTOR



| Model | Year | Bore Size | Top End Kit | List Price | Component Part# | Component Description | List Price | OEM Part # |
|--------|------|-----------|-------------|------------|-----------------|-----------------------|------------|-----------------|
| YFM80 | ALL | 48mm | C3457 | \$19.99 | H1905043F | 48mm Head Gasket | \$11.41 | 55X-11181-00-00 |
| RAPTOR | | | | | B0721020F | Base Gasket | \$6.25 | 22F-11351-01-00 |
| | | | | | EX781 | Exhaust Gasket | \$3.35 | 3DM-14613-00-00 |

YZ80

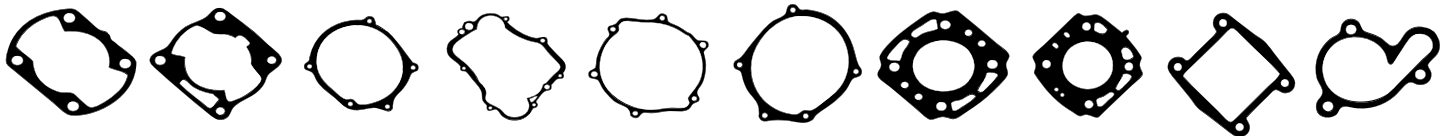

| Model | Year | Bore Size | Top End Kit | List Price | Component Part# | Component Description | List Price | OEM Part # |
|-------|------|-----------|----------------|------------|-----------------|--------------------------|------------|-----------------|
| YZ80 | 83 | 49 mm | C7105 | \$19.14 | H0058043F | Head Gasket | \$14.87 | 58T-11181-01-00 |
| | | | | | B0058020F | Base Gasket | \$4.65 | 4VD-11351-00-00 |
| | | | Crank Seal Kit | \$11.70 | OS116 | Right Crank Seal 27X40X8 | \$7.10 | 93103-28011 |
| | | | | | OS115 | Left Crank Seal 19X40X8 | \$5.91 | 93102-20447 |



MX/Dirt • Off-Road • ATV Gaskets



Cometic Gasket - An Exclusive NASCAR Performance® Product

YAMAHA

| Model | Year | Bore Size | Top End Kit | List Price | Component Part# | Component Description | List Price | OEM Part # | |
|-----------------------------------|-------|--------------------------|----------------|-------------------|--|---|---|--|---|
| YZ80 | 84 | 50 mm | Top End Kit | C7106 | \$19.14 | H0059043F B0058020F | Head Gasket Base Gasket | \$14.87 \$4.65 | 58T-11181-01-00 4VD-11351-00-00 |
| | | | Crank Seal Kit | C7666 | \$11.70 | OS116 OS115 | Right Crank Seal 27X40X8 Left Crank Seal 19X40X8 | \$7.10 \$5.91 | 93103-28011 93102-20447 |
| YZ80 N | 85 | 50 mm | Top End Kit | C7076 | \$22.99 | H0059043F B0058020F IR014018AFM | Head Gasket Base Gasket Intake Gasket | \$14.87 \$4.65 \$3.80 | 58T-11181-01-00 4VD-11351-00-00 1LR-13621-00-00 |
| | | | Crank Seal Kit | C7666 | \$11.70 | OS116 OS115 | Right Crank Seal 27X40X8 Left Crank Seal 19X40X8 | \$7.10 \$5.91 | 93103-28011 93102-20447 |
| YZ80 KR, Z,HF,V, W,B | 86-92 | 50 mm | Top End Kit | C7080 | \$22.99 | H0060043F B0058020F IR014018AFM R127V | Head Gasket Base Gasket Intake Gasket Exhaust O-ring | \$14.87 \$4.65 \$3.80 \$3.92 | 1LR-11181-01-00 4VD-11351-00-00 1LR-13621 93210-40745-00 |
| | | | Crank Seal Kit | C7666 | \$11.70 | OS116 OS115 | Right Crank Seal 27X40X8 Left Crank Seal 19X40X8 | \$7.10 \$5.91 | 93103-28011 93102-20447 |
| YZ80 | 93-01 | O-Ring 54 mm Big Bore | Top End Kit | C7137 | \$22.99 | R85X2V | Outer Head O-ring | \$7.14 | 93210-84724-00 |
| | | | C7331 | \$22.99 | R55X2V H0303043F B0120018AFM B0120012F R127V | Inner Head O-ring 54mm Big Bore Head Gasket Base Gasket High Comp. Base Gasket .012" Exhaust O-ring | \$2.34 \$17.38 \$12.39 \$5.34 \$3.92 | 93210-56459-00 4ES-11351-00-00 5PA-14642-00-00 | |
| Bottom End Kit w/Oil Seals | | | | List Price | Component Part# | Component Description | List Price # | OEM Part # | |
| C7137BE | | | | \$57.55 | WP054018AFM | Water Pump Gasket | \$12.39 | 4BA-12428-00-00 | |
| | | | | | WA118 | Water Pump Drain Plug | \$1.88 | 90430-06166-00 | |
| | | | | | WA116 | Case Drain Crush Washer | \$3.02 | 90430-08119-00 | |
| | | | | | R116B | Fill Plug O-ring | \$1.13 | 93210-19123-00 | |
| Oil Seal Kit | | | | List Price | Component Part# | Component Description | List Price # | OEM Part # | |
| C7137OS | | | | \$46.55 | OS354 | Shift Shaft Seal 11.5X21X4 | \$4.46 | 93101-12173-00 | |
| Crank Seal Kit | | | | List Price | Component Part# | Component Description | List Price # | OEM Part # | |
| C7666 | | | | \$11.70 | OS286 | Clutch Pushrod Oil seal 12x18x5 | \$4.29 | 93102-12224-00 | |
| | | | | | OS232 | Start Shaft Seal 17x25x4 | \$4.46 | 93102-17263-00 | |
| | | | | | OS225 | Output Shaft Seal 20X30X5 | \$5.03 | 93102-20143-00 | |
| | | | | | OS173 | Left Crank Seal 27x40x8 | \$8.29 | 93102-20447-00 | |
| | | | | | OS115 | Right Crank Seal 19Xx40x8 | \$5.91 | 93103-28126-00 | |
| | | | | | OS226 | Water Pump Oil Seal 10x31x13.5 | \$14.11 | 93103-10147-00 /93103-10168-00 | |
| Clutch & Mag Kit | | | | List Price | Component Part# | Component Description | List Price | OEM Part # | |
| C7137CM | | | | \$21.30 | C7500 | Clutch Cover | \$8.69 | 4ES-15461-00-00 | |
| | | | | | EC219060AFM | Mag Cover | \$12.39 | 4ES-15451-00-00 | |



MX/Dirt · Off-Road · ATV Gaskets



Cometic Gasket - An Exclusive NASCAR Performance® Product

YAMAHA

| Model | Year | Bore Size | Top End Kit | List Price | Component Part# | Component Description | List Price | OEM Part # |
|-------|-------|-----------------------------------|-------------|-------------------|------------------------|---------------------------------|---------------------|-------------------|
| YZ85 | 02-16 | O-Ring | C7851 | \$25.55 | R85X2V | Outer Head O-ring | \$7.14 | 93210-84724-00 |
| | | | | | R57X2V | Inner Head O-ring | \$3.20 | 93210-56459-00 |
| | | | | | B0120018AFM | Base Gasket | \$12.39 | 4ES-11351-00-00 |
| | | | | | B0120012F | High Comp. Base Gasket .012" | \$5.34 | |
| | | | | | R127V | Exhaust O-ring 2 Req. | \$3.92 | 5PA-14642-00-00 |
| | | Bottom End Kit w/Oil Seals | | | Component Part# | Component Description | List Price # | OEM Part # |
| | | C7851BE | | \$57.55 | WP054020F | Water Pump Gasket | \$12.39 | 4BA-12428-00-00 |
| | | | | | EC220020F | Inner Clutch Cover | \$8.69 | 4ES-15461-00-00 |
| | | | | | WA116 | Drain Plug Gasket | \$3.02 | 90430-08119-00 |
| | | | | | R117B | Fill Plug O-ring | \$0.42 | 93210-19123-00 |
| | | Oil Seal Kit | | List Price | Component Part# | Component Description | List Price # | OEM Part # |
| | | C7851OS | | \$40.36 | OS354 | Shift Shaft Seal 11.5X21X4 | \$4.46 | 93101-12173-00 |
| | | Crank Seal Kit | | List Price | OS286 | Clutch Pushrod Oil seal 12x18x5 | \$4.29 | 93102-12224-00 |
| | | C7666 | | \$11.70 | OS227 | Water Pump Seal 12x22x5 | \$2.67 | 93102-12321-00 |
| | | | | | OS232 | Start Shaft Seal 17x25x4 | \$4.46 | 93102-17263-00 |
| | | | | | OS173 | Left Crank Seal 27x40x8 | \$8.29 | 93102-20447-00 |
| | | | | | OS358 | Output Shaft Seal 26X38X5 | \$5.94 | 93102-26042-00 |
| | | | | | OS115 | Right Crank Seal 19Xx40x8 | \$5.91 | 93102-28009-00 |
| | | | | | OS283 | Impeller Seal 11x25x7 | \$4.34 | 93109-11073-00 |
| | | Clutch & Mag Kit | | List Price | Component Part# | Component Description | List Price | OEM Part # |
| | | C7851CM | | \$18.16 | EC640060AFM | Mag Cover Gasket | \$9.47 | 5PA-15451-00-00 |
| | | | | | EC632018AFM | Outer Clutch Cover Gasket | \$8.69 | 93210-12152-00 |

TTR90



| Model | Year | Bore Size | Top End Kit | List Price | Component Part# | Component Description | List Price | OEM Part # |
|--------|-------|-----------|-------------|------------|-----------------|----------------------------|------------|-----------------|
| TT-R90 | 00-08 | 48mm | C3249-EST | \$54.99 | H2813SP1043F | Head Gasket | \$18.56 | 4GL-11181-00-00 |
| | | | | | B0956010RC | Base Gasket | \$6.25 | 5HN-11351-00-00 |
| | | | | | EC1286018AFM | Cam Chain Tensioner | \$2.04 | 90430-06014-00 |
| | | | | | 3179V | Valve Seals 2 Req. | \$5.50 ea. | 1WG-12119-00-00 |
| | | | | | R013V | Valve Guide O-ring 2 Req. | \$1.08 | 93210-09418-00 |
| | | | | | R133B | Valve Cover O-rings 2 Req. | \$1.13 | 93210-44704-00 |
| | | | | | WA114 | Cam Chain Washer 2 Req. | \$3.02 | 90430-06014-00 |
| | | | | | R62X2V | Cam Gear Cover | \$4.64 | 93210-63556-00 |

YZ125

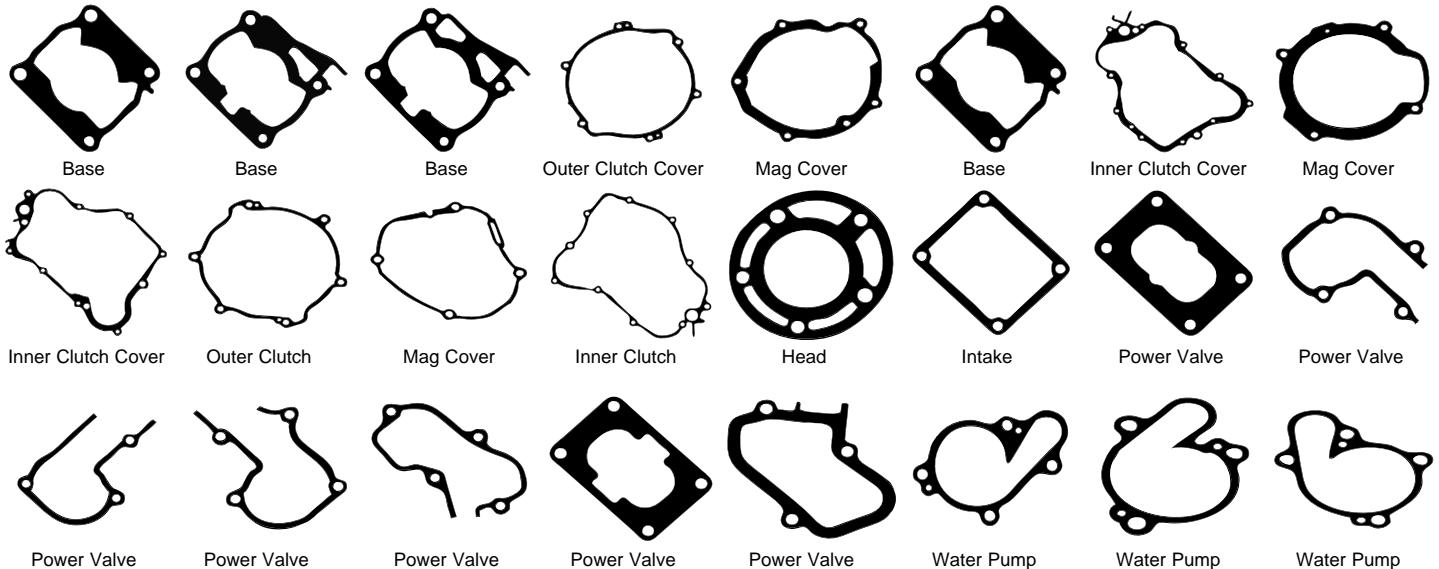



MX/Dirt · Off-Road · ATV Gaskets



Cometic Gasket - An Exclusive NASCAR Performance® Product

YZ125

| Model | Year | Bore Size | Top End Kit | List Price | Component Part# | Component Description | List Price | OEM Part # |
|------------------|-------|-----------|-------------|------------|--|---|--|--|
| YZ125 | 83-84 | 58 mm | C7107 | \$22.99 | H0061043F B0059020F | Head Gasket Base Gasket | \$17.38 \$5.34 | 55Y-11181-01-00 24X-11351-00-00 |
| YZ125 N | 85 | 58 mm | C7081 | \$31.91 | H0061043F B0059020F IR015020F PV029020F PV030020F | Head Gasket Base Gasket Intake Gasket Right Side Power Valve Cover Left Side Power Valve Gasket | \$17.38 \$5.34 \$3.80 \$3.80 \$3.80 | 55Y-11181-01-00 24X-11351-00-00 39W-13621-01-00 5X4-1131N-00-00 5X4-11993-00-00 |
| YZ125 S, T, J | 86-88 | O-Ring | C7082 | \$31.91 | R105X2B R63X2V B0060020F PV035020F PV029020F IR016020F | Outer Head O-ring Inner Head O-ring Base Gasket Right Side Power Valve Gasket Left Side Power Valve Cover Intake Gasket | \$2.57 \$4.57 \$5.34 \$3.80 \$3.80 \$3.80 | 93211-07720-00 93210-65721-00 1LX-11351-00-00 2VM-11993-00-00 5X4-1131N-00-00 3XP-13621-00-00 |
| | | | C7668 | \$19.21 | OS118 OS123 | Left Crank Seal 21X40X7 Right Crank Seal 30X44X8 | \$7.10 \$14.25 | 93102-22363-00 93103-32171-00 |
| YZ125 W | 89 | O-Ring | C7083 | \$31.91 | R105X2B R63X2V B0060020F IR017020F PV035020F PV029020F | Outer Head O-ring Inner Head O-ring Base Gasket Intake Gasket Right Side Power Valve Gasket Left Side Power Valve Cover | \$2.57 \$4.57 \$5.34 \$3.80 \$3.80 \$3.80 | 93211-07720-00 93210-65721-00 1LX-11351-00-00 80L-13621-01-00 2VM-11993-00-00 5X4-1131N-00-00 |
| | | | C7668 | \$19.21 | OS118 OS123 | Left Crank Seal 21X40X7 Right Crank Seal 30X44X8 | \$7.10 \$14.25 | 93102-22363-00 93103-32171-00 |
| | | | | | C7481 | Clutch Cover | \$6.48 | 3JD-15463-10-00 |
| YZ125 | 90-91 | O-Ring | C7084 | \$30.66 | R105X2B R63X2V B0060020F IR017020F PV035020F PV029020F | Outer Head O-ring Inner Head O-ring Base Gasket Intake Gasket Right Side Power Valve Gasket Left Side Power Valve Cover | \$2.57 \$4.57 \$5.34 \$3.80 \$3.80 \$3.80 | 93211-07720-00 93210-65721-00 1LX-11351-00-00 80L-13621-01-00 2VM-11993-00-00 5X4-1131N-00-00 |
| | | | C7668 | \$19.21 | OS118 OS123 | Left Crank Seal 21X40X7 Right Crank Seal 30X44X8 | \$7.10 \$14.25 | 93102-22363-00 93103-32171-00 |
| | | | | | C7481 | Clutch Cover | \$6.48 | 3JD-15463-10-00 |
| YZ125 | 92-93 | O-Ring | C7139 | \$30.66 | R105X2B R63X2V B0060020F R221V IR017020F PV033020F PV032020F | Outer Head O-ring Inner Head O-ring Base Gasket Exhaust O-ring Intake Gasket Right Side Power Valve Gasket Left Side Power Valve Gasket | \$2.57 \$4.57 \$5.34 \$3.92 \$3.80 \$3.80 \$3.80 | 93211-07720-00 93210-65721-00 1LX-11351-00-00 93210-45742-00 80L-13621-01-00 4DB-11993-01-00 4DB-1131N-00-00 |
| | | | C3294 | \$37.52 | EC284020F EC283020F C7481 WP060020F | Inner Clutch Gasket Mag Cover Gasket Clutch Cover Water Pump Gasket | \$8.29 \$6.25 \$6.48 \$4.54 | 1LX-15462-10 4DB-15451-00 3JD-15463-10 1LX-12428-01 |
| | | | C7668 | \$19.21 | OS118 OS123 | Left Crank Seal 21X40X7 Right Crank Seal 30X44X8 | \$7.10 \$14.25 | 93102-22363-00 93103-32171 |



MX/Dirt • Off-Road • ATV Gaskets



Cometic Gasket - An Exclusive NASCAR Performance® Product

YAMAHA

| Model | Year | Bore Size | Top End Kit | List Price | Component Part# | Component Description | List Price | OEM Part # | | |
|-------------------------------------|-------------------|------------------------|-----------------------------------|---------------------|-------------------------------------|--------------------------------|------------------------|------------------------------|---------------------|-------------------|
| YZ125 | 94-97 | O-Ring | C7158 | \$30.66 | R90X2B | Outer Head O-ring | \$2.86 | 93210-90785-00 | | |
| | | | | | R63X2V | Inner Head O-ring | \$4.57 | 93210-63442-00 | | |
| | | | | | B0153018AFM | Base Gasket | \$7.10 | 4JY-11351-00 | | |
| | | | | | B0153012F | Base Gasket High Comp. 012" | \$9.32 | 4JY-11351-00 | | |
| | | | | | R223V | Exhaust O-ring 2 Req. | \$3.92 | 93210-42728-00 | | |
| | | | | | PV059018AFM | Front Power Valve Gasket | \$3.80 | 4JY-11354-00 | | |
| | | | | | PV041018AFM | Right Power Valve Gasket | \$3.80 | 4JY-11993-00-00 | | |
| | | | | | Bottom End Kit w/crank seals | List Price | Component Part# | Component Description | List Price | OEM Part # |
| | | | | | C3295 | \$37.52 | EC268032AFM | Inner Clutch Cover Gasket | \$8.29 | 4JY-15462-00 |
| | | | | | | | EC224018AFM | Mag Cover Gasket | \$6.25 | 4JY-15451-00 |
| | | | | | | | C7489 | Clutch Cover | \$6.48 | 4JY-15463-00 |
| | | | | | | | WP043018AFM | Water Pump Gasket | \$4.54 | 4JY-12428-00 |
| | | | | | Clutch & Mag Kit C7158CM | List Price | Component Part# | Component Description | List Price | OEM Part # |
| | | | | | | \$12.73 | C7500 | Clutch Cover Gasket | \$8.91 | 4ES-15461-00 |
| | | EC219060AFM | Mag Cover Gasket | \$12.39 | 4ES-15451-00 | | | | | |
| Crank Seal Kit C7705 | List Price | Component Part# | Component Description | List Price | OEM Part # | | | | | |
| | \$25.55 | OS118 | Left Crank Seal 21X40X7 | \$7.10 | 93102-22363-00 | | | | | |
| | | OS123 | Right Crank Seal 30X44X8 | \$14.25 | 93103-32171-00 | | | | | |
| YZ125 | 98-00 | O-Ring | C7399 | \$30.66 | R90X2B | Outer Head O-ring | \$2.86 | 93210-90785-00 | | |
| | | | | | R63X2V | Inner Head O-ring | \$4.57 | 93210-63442-00 | | |
| | | | | | B0318018AFM | Base Gasket | \$7.49 | 5DH-11351-01-00 | | |
| | | | | | B0318012F | High Compression Base Gasket | \$9.32 | 5DH-11351-01-00 | | |
| | | | | | PV059018AFM | Front Power Valve Cover Gasket | \$3.80 | 4JY-11354-00 | | |
| | | | | | PV041018AFM | Right Side Power Valve Gasket | \$3.80 | 4JY-11993-00 | | |
| | | | | | R224V | Exhaust O-rings 98-00 2 Req. | \$1.19 | 93210-45742-00 | | |
| | | | | | R223V | Exhaust O-rings 2001 2 Req. | \$3.92 | 5MV-14642-00-00 | | |
| | | | | | Bottom End Kit w/Oil Seals | List Price | Component Part# | Component Description | List Price # | OEM Part # |
| | | | | | C7399BE | \$62.77 | EC268032AFM | Inner Clutch Gasket | \$8.29 | 4JY-15462-00 |
| | | | | | | | WP043018AFM | Water Pump Gasket | \$4.54 | 4JY-12428-00 |
| | | | | | | | R018V | Case Dowel Pin O-ring | \$1.19 | 93210-16314-00 |
| | | | | | | | WA114 | Drain Plug Gasket | \$3.02 | 90430-12207-00 |
| | | | | | | | R19X2V | Fill Plug O-ring | \$2.50 | 93210-19123-00 |
| Oil Seal Kit C7399OS | List Price | Component Part# | Component Description | List Price # | OEM Part # | | | | | |
| | \$48.46 | OS117 | Right Side Crank Seal | 7.10 | 93103-32183-00 | | | | | |
| Crank Seal Kit C7667 | List Price | Component Part# | Component Description | List Price # | OEM Part # | | | | | |
| | \$12.78 | OS118 | Left Side Crank Seal | \$7.10 | 93102-22363-00 | | | | | |
| | | OS227 | Inner Water Pump Oil Seal 12x22x5 | \$2.67 | 93102-12321-00 | | | | | |
| | | OS228 | Shift Shaft Seal 12x19x5 | \$4.51 | 93109-12012-00 | | | | | |
| | | OS231 | Power Valve Shaft Oil Seal 8x12x3 | \$4.86 | 93104-08040-00 | | | | | |
| | | OS232 | Starter Shaft Seal 17x25x4 | \$4.46 | 93102-17263-00 | | | | | |
| | | OS242 | Water Pump Oil Seal 12x25x7 | \$2.67 | 93109-11073-00 | | | | | |
| | | OS286 | Clutch Pushrod Oil Seal 12x18x5 | \$4.29 | 93102-12224-00 | | | | | |
| | | OS358 | Output Shaft Seal 28x38x5 | \$5.94 | 93102-26042-00 | | | | | |
| Clutch & Mag Kit C7158CM | List Price | Component Part# | Component Description | List Price | OEM Part # | | | | | |
| | \$12.73 | C7500 | Clutch Cover Gasket | \$8.91 | 4ES-15461-00 | | | | | |
| | | EC219060AFM | Mag Cover Gasket | \$12.39 | 4ES-15451-00 | | | | | |



MX/Dirt · Off-Road · ATV Gaskets



Cometic Gasket - An Exclusive NASCAR Performance® Product

YAMAHA

| Model | Year | Bore Size | Top End Kit | List Price | Component Part# | Component Description | List Price | OEM Part # | | | | | |
|--|------------------------------|---------------------------------------|---|-----------------------------|--|--------------------------------|---------------------------------|---|-------------------------------|-------------------------------------|-------------------|--------|-----------------|
| YZ125 | 01-02 | O-Ring | C7853 | \$33.17 | R90X2B | Outer Head O-ring | \$2.86 | 93210-90785-00 | | | | | |
| | | | | | R63X2V | Inner Head O-ring | \$4.57 | 93210-63442-00 | | | | | |
| | | | | | B0318018AFM | Base Gasket | \$7.49 | 5DH-11351-01-00 | | | | | |
| | | | | | B0318012F | High Compression Base Gasket | \$9.32 | 5DH-11351-01-00 | | | | | |
| | | | | | PV059018AFM | Front Power Valve Cover Gasket | \$3.80 | 4JY-11354-00 | | | | | |
| | | | | | PV041018AFM | Right Side Power Valve Gasket | \$3.80 | 4JY-11993-00 | | | | | |
| | | | | | R223V | Exhaust O-rings 2001 2 Req. | \$3.92 | 5MV-14642-00-00 | | | | | |
| YZ125 | 03-04 | O-Ring | C7936 | \$33.17 | R90X2B | Outer Head O-ring | \$2.86 | 93210-90785-00 | | | | | |
| | | | | | R63X2V | Inner Head O-ring | \$4.57 | 93210-63442-00 | | | | | |
| | | | | | B0318032AFM | Base Gasket | \$7.49 | 5DH-11351-01-00 | | | | | |
| | | | | | B0318012F | High Compression Base Gasket | \$9.32 | 5DH-11351-01-00 | | | | | |
| | | | | | PV114018AFM | Front Power Valve Gasket | \$3.80 | 4JY-11993-00 | | | | | |
| | | | | | PV041018AFM | Right Side Power Valve Gasket | \$3.80 | 4JY-11993-00 | | | | | |
| | | | | | R223V | Exhaust O-rings 2001 2 Req. | \$3.92 | 5MV-14642-00-00 | | | | | |
| YZ125 | 01-04 | O-Ring | Bottom End Kit w/Oil Seals C7853BE | \$64.13 | R018V | Case O-ring | \$2.90 | 93210-16314-00 | | | | | |
| | | | | | WA114 | Drain Plug Gasket | \$2.90 | 90430-12207-00 | | | | | |
| | | | | | EC268020F | Inner Clutch Cover Gasket | \$17.15 | 4JY-15462-00-00 | | | | | |
| | | | | | R19X2V | Trans Fill Plug O-ring | \$2.40 | 93210-19123-00 | | | | | |
| | | | | | WA114 | Clutch Drain Plug Gasket | \$2.90 | 90430-06014-00 | | | | | |
| | | | | | WP043018AFM | Water Pump Cover Gasket | \$4.54 | 4JY-12428-10-00 | | | | | |
| | | | | | Oil Seal Kit C7853OS | List Price \$56.26 | Component Part# OS110 | Component Description Left Crank Seal | List Price # \$9.47 | OEM Part # 93102-20485-00 | | | |
| | | | | | Crank Seal Kit C7802 | List Price \$21.35 | OS182 | Right Crank Seal | \$11.87 | 93102-30008-00 | | | |
| | | | | | | | OS227 | Water Pump Shaft Seal | \$5.21 | 93102-12321-00 | | | |
| | | | | | | | OS228 | Shift Shaft Seal | \$3.62 | 93109-12012-00 | | | |
| | | | | | | | OS231 | PV Governor Oil Seal | \$5.19 | 93104-08040-00 | | | |
| | | | | | | | OS232 | Kickstart Shaft Seal | \$5.14 | 93102-17263-00 | | | |
| | | | | | | | OS283 | Impeller Seal | \$4.34 | 93109-11073-00 | | | |
| | | | | | | | OS286 | Clutch Pushrod Seal | \$5.48 | 93102-12224-00 | | | |
| | | | | | | | OS358 | Output Shaft Seal | \$5.94 | 93102-26042-00 | | | |
| | | | | | Clutch & Mag Kit C7158CM | List Price \$12.73 | Component Part# C7500 | Component Description Clutch Cover Gasket | List Price \$8.91 | OEM Part # 4ES-15461-00 | | | |
| | | | | | | | EC219060AFM | Mag Cover Gasket | \$12.39 | 4ES-15451-00 | | | |
| | | | | | YZ125 | 05-14 | O-Ring | C3105 | \$33.17 | R90X2B | Outer Head O-ring | \$2.86 | 93210-90785-00 |
| | | | | | | | | | | R63X2V | Inner Head O-ring | \$4.57 | 93210-63442-00 |
| | | | | | | | | | | B0749032AFM | Base Gasket | \$7.49 | 1C3-11351-00-00 |
| B0749018AFM | Base Gasket | \$7.49 | 1C3-11351-00-00 | | | | | | | | | | |
| R223V | Exhaust O-rings 2001 2 Req. | \$3.92 | 5MV-14642-00-00 | | | | | | | | | | |
| PV131018AFM | Right Side Power Valve Cover | \$3.80 | 1C3-11993-00-00 | | | | | | | | | | |
| PV114018AFM | Front Power Valve Gasket | \$3.80 | 4JY-11354-10-00 | | | | | | | | | | |
| WA136 | Head Crush Washers 5 Req. | \$1.31 | 90201-080L8-00 | | | | | | | | | | |
| Bottom End Kit C3298 | List Price \$36.99 | Component Part# EC927032AFM | Component Description Clutch Cover Gasket | List Price \$9.94 | | | | | | OEM Part # 1C3-15463-00 | | | |
| | | EC1006018AFM | Inner Clutch Gasket | \$17.84 | | | | | | 1C3-15462-00-00 | | | |
| | | EC1005018AFM | Mag Cover Gasket | \$8.29 | | | | | | 1C3-15451-00 | | | |
| | | R19X2V | Clutch Fill Plug O-ring | \$2.50 | | | | | | 93210-19123-00 | | | |
| | | WA114 | Drain Plug Seal | \$3.02 | | | | | | 90430-12207-00 | | | |
| | | WP177032AFM | Water Pump Gasket | \$4.72 | | | | | | 1C3-12428-00-00 | | | |
| Clutch & Mag Kit C3105CM | List Price \$18.23 | Component Part# EC927032AFM | Component Description Clutch Cover Gasket | List Price \$9.94 | | | | | | OEM Part # 1C3-15463-00 | | | |
| | | EC1005018AFM | Mag Cover Gasket | \$8.29 | | | | | | 1C3-15451-00 | | | |



MX/Dirt • Off-Road • ATV Gaskets



Cometic Gasket - An Exclusive NASCAR Performance® Product

TTR125

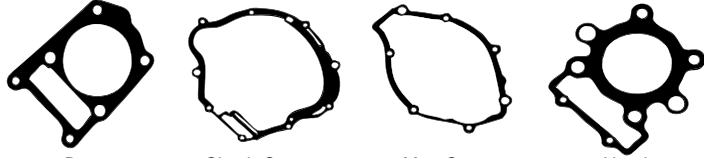

| Model | Year | Bore Size | Top End Kit | List Price | Component Part# | Component Description | List Price | OEM Part # |
|--------|-------|-----------|-----------------------|-------------------|------------------------|------------------------------|-------------------|-------------------|
| TTR125 | 99-05 | 55 mm | C7755 | \$28.11 | H1014010S | Head Gasket | \$11.18 | 5AP-11181-00 |
| | | | C7815 | \$28.11 | H1014SP1010S | Head Gasket 58mm Bore | \$11.18 | 5AP-11181-00 |
| | | 58 mm | | | B0478020F | Base Gasket | \$3.12 | 5HP-11351-00 |
| | | | | | R70X2S | Base O-ring | \$3.21 | 93210-57897-00 |
| | | | | R140V | Cam Cover O-ring | \$3.29 | 93210-71462-00 | |
| | | | Bottom End Kit | List Price | Component Part# | Component Description | List Price | OEM Part # |
| | | | C3299 | \$11.99 | EC471020F | Mag Cover Gasket | \$7.12 | 5HP-15451-00 |
| | | | | | EC470020F | Clutch Cover Gasket | \$6.71 | 5HP-15461-00 |
| | | | | | R132V | Tappet Cover O-ring 2 Req | \$1.19 | 93210-44704-00 |
| YT125 | 80-83 | 58 mm | Top End Kit | List Price | Component Part# | Component Description | List Price | OEM Part # |
| | | | C7127 | \$21.76 | H0068043F | Head Gasket | \$17.38 | 3X3-11181-01-00 |
| | | | | | B0069020F | Base Gasket | \$5.34 | 18G-11351-01-00 |
| YT175 | 82-84 | 68 mm | Top End Kit | List Price | Component Part# | Component Description | List Price | OEM Part # |
| | | | C7128 | \$21.76 | H0069043F | Head Gasket | \$19.82 | 5V7-11181-00-00 |
| | | | | | B0069020F | Base Gasket | \$5.34 | 18G-11351-01-00 |

YFS200

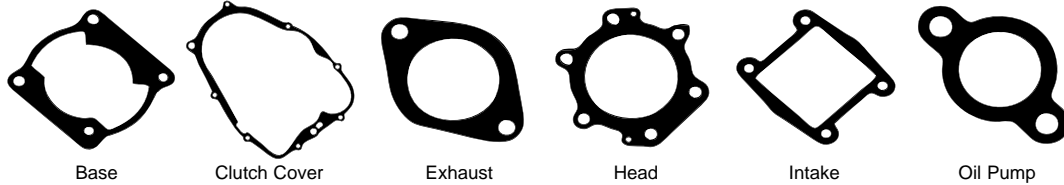

| Model | Year | Bore Size | EST | List Price | Component Part# | Component Description | List Price | OEM Part # | | |
|-------------------|-------|-----------|-----------------------|-------------------|------------------------|------------------------------|------------------------|---------------------------------|---------------------|-------------------|
| YFS200 Blaster | 88-06 | 68 mm | C7093-EST | \$41.68 | H2532SP1030S | Head Gasket 68mm Steel | \$27.26 | 2XJ-11181-00-00 | | |
| | | | C7332-EST | \$41.68 | H2532030S | Head Gasket 72.5mm Steel | \$27.26 | 2XJ-11181-00-00 | | |
| | | | | | H0064032C | Head Gasket 68mm Copper | \$24.98 | 2XJ-11181-00-00 | | |
| | | | | | H0386032C | Head Gasket 72.5mm Copper | \$24.98 | 2XJ-11181-00-00 | | |
| | | | | | B0065018AFM | Base Gasket | \$6.25 | 3JM-11351-01-00 | | |
| | | | | | IR014018AFM | Intake Gasket | \$3.80 | 1LR-13621 | | |
| | | | | | EX350064AM | Exhaust Gasket | \$13.29 | 3PA-14613-10-00 | | |
| YFS200 Blaster | 88-05 | 72.5 mm | Bottom End Kit | List Price | Component Part# | Component Description | List Price | OEM Part # | | |
| | | | C7093BE | \$70.74 | OP032018AFM | Oil Pump Cover Gasket | \$4.77 | 126-13116-01-00 | | |
| | | | | | EC316032AFM | Clutch Cover Gasket | \$18.12 | 3JM-15451-11-00/2XJ-15411-00-00 | | |
| | | | | | R19X2V | Oil Fill Plug O-ring 19X2.4 | \$2.50 | 93210-19123-00 | | |
| | | | | | WA120 | Drain Plug Gasket | \$0.83 | 90201-12172-00 | | |
| | | | | | Oil Seal Kit | List Price | Component Part# | Component Description | List Price # | OEM Part # |
| | | | | | C7093OS | \$44.52 | OS112 | Right Crank Seal 32X44X9 | \$10.68 | 93103-32099-00 |
| | | | | | | | OS124 | Left Crank Seal 25X44X8 | \$10.68 | 93102-25331-00 |
| | | | | | | | OS225 | Output Shaft Seal 20X30X5 | \$5.03 | 93102-20143-00 |
| | | | | | | | OS262 | Oil Pump Seal 10X21X5 | \$2.60 | 93101-10001-00 |
| | | | | | | | OS354 | Shift Shaft Seal 12X21X4 | \$4.46 | 93101-12173-00 |
| | | | | | | | OS355 | Clutch Actuator Seal 14X25X5 | \$5.07 | 93104-14004-00 |
| | | | | | | | OS356 | Start Shaft Seal 20X38X5 | \$6.00 | 93109-20014-00 |
| YTM200 | 83-85 | 71 mm | Top End Kit | List Price | Component Part# | Component Description | List Price | OEM Part # | | |
| | | | C7129 | \$34.53 | H0066043F | Head Gasket | \$19.82 | 1NU-11181-00-00 | | |
| | | | | | B0067020F | Base Gasket | \$5.34 | 4BD-11351-00-00 | | |
| YFM200 | 85-89 | 71 mm | Top End Kit | List Price | Component Part# | Component Description | List Price | OEM Part # | | |
| | | | C7095 | \$29.35 | H0066043F | Head Gasket | \$19.82 | 1NU-11181-00-00 | | |
| | | | | | B0067020F | Base Gasket | \$5.34 | 4BD-11351-00-00 | | |
| DT/WR200 | 90-92 | 68 mm | Top End Kit | List Price | Component Part# | Component Description | List Price | OEM Part # | | |
| | | 72 mm | C7142 | \$26.29 | H0178043F | Head Gasket | \$19.82 | 4TP-11181-00-00 | | |
| | | | C7330 | \$26.29 | H0450043F | Head Gasket 72mm | \$19.82 | | | |
| | | | | | B0135020F | Base Gasket | \$6.25 | 4TP-11351-00-00 | | |
| YFM225 | 86-88 | 71 mm | Top End Kit | List Price | Component Part# | Component Description | List Price | OEM Part # | | |
| | | | C7253 | \$35.72 | H0066043F | Head Gasket | \$19.82 | 59V-11181-00-00 | | |
| | | | | | B0067020F | Base Gasket | \$5.34 | 4BD-11351-00-00 | | |



MX/Dirt · Off-Road · ATV Gaskets



Cometic Gasket - An Exclusive NASCAR Performance® Product

YZ250

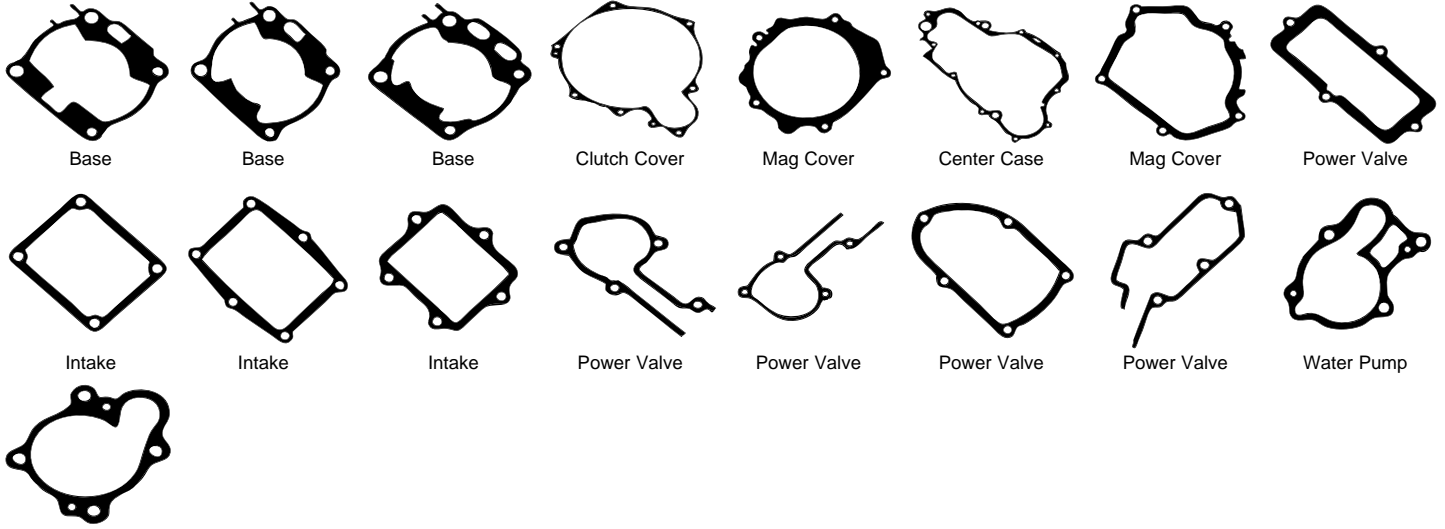

| Model | Year | Bore Size | Top End Kit | List Price | Component Part# | Component Description | List Price | OEM Part # | | | | | | | | |
|-------------------------|------------------------|-----------------|------------------|-----------------------|-------------------------|-------------------------------|-----------------|-----------------|-----------------------|-------------------------|-------------------|------------|----------------|---------------------------|------------|------------|
| YZ250 | 86-87 | O-Ring | C7086 | \$36.99 | R115X2B | Outer Head O-ring | \$2.86 | 93211-17405-00 | | | | | | | | |
| | | | | | R76X2V | Inner Head O-ring | \$3.64 | 93210-77363-00 | | | | | | | | |
| | | | | | B0061020F | Base Gasket | \$6.25 | 1LU-11351-00-00 | | | | | | | | |
| | | | | | IR018018AFM | Intake Gasket | \$3.80 | 2K7-13621-00-00 | | | | | | | | |
| | | | | | PV034020F | Right Side Power Valve Gasket | \$3.80 | 1LU-11993-00-00 | | | | | | | | |
| | | | | | PV029020F | Left Side Power Valve Gasket | \$3.80 | 5X4-1131N-00-00 | | | | | | | | |
| YZ250 | 88 | O-Ring | C7087 | \$36.99 | R110X2B | Outer Head O-ring | \$2.86 | 93211-11770-00 | | | | | | | | |
| | | | | | R76X2V | Inner Head O-ring | \$3.64 | 93210-77363-00 | | | | | | | | |
| | | | | | B0061020F | Base Gasket | \$6.25 | 1LU-11351-00-00 | | | | | | | | |
| | | | | | IR018018AFM | Intake Gasket | \$3.80 | 2K7-13621-00-00 | | | | | | | | |
| | | | | | PV037020F | Right Side Power Valve | \$3.80 | 2VM-11993-00-00 | | | | | | | | |
| | | | | | PV029020F | Left Side Power Valve Gasket | \$3.80 | 5X4-1131N-00-00 | | | | | | | | |
| | | | | | R228V | Exhaust O-ring | \$3.92 | 93210-56743-00 | | | | | | | | |
| | | | | | Crank Seal Kit C7669 | List Price \$12.78 | Component Part# | OS118 | Component Description | Left Crank Seal 21X40X7 | List Price | OEM Part # | | | | |
| | | | | | | | | | | | | | OS119 | Right Crank Seal 34X55X10 | List Price | OEM Part # |
| | | | | | | | | | | | | | | | | |
| | | | | | YZ250 | 89-90 | O-Ring | C7088 | \$35.72 | R110X2B | Outer Head O-ring | \$2.86 | 93211-11770-00 | | | |
| | | | | | | | | | | R76X2V | Inner Head O-ring | \$3.64 | 93210-77363-00 | | | |
| B0062018AFM | Base Gasket | \$6.25 | 2VM-11351-10 | | | | | | | | | | | | | |
| B0062012F | Base Gasket | \$9.32 | 2VM-11351-10 | | | | | | | | | | | | | |
| PV037020F | Right Side Power Valve | \$3.80 | 2VM-11993-00-00 | | | | | | | | | | | | | |
| PV036018AFM | Left Side Power Valve | \$3.80 | 3JE-1131N-10-00 | | | | | | | | | | | | | |
| IR017020F | Intake Gasket | \$3.80 | 8CH/8DF-13621-00 | | | | | | | | | | | | | |
| R228V | Exhaust O-ring | \$3.92 | 93210-56743-00 | | | | | | | | | | | | | |
| Crank Seal Kit C7669 | List Price \$12.78 | Component Part# | OS118 | Component Description | | | | | | Left Crank Seal 21X40X7 | List Price | OEM Part # | | | | |
| | | | | | | | | | | | | | C7488 | Clutch Cover | List Price | OEM Part # |
| | | | | | | | | | | | | | | | | |



MX/Dirt • Off-Road • ATV Gaskets



Cometic Gasket - An Exclusive NASCAR Performance® Product

YAMAHA

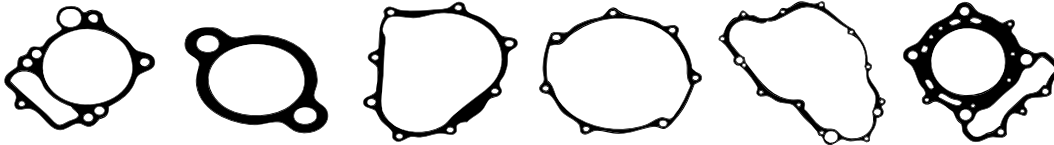

Base Cam Chain Tensioner Mag Cover Outer Clutch Cover Inner Clutch Cover Head

| Model | Year | Bore Size | Top End Kit | List Price | Component Part# | Component Description | List Price | OEM Part # | | | | | |
|-------------------------------------|-------------------------------|------------------------|------------------------------|-------------------|-------------------------------------|-------------------------------|------------------------|------------------------------|-------------------|-------------------|-------------------|--------|----------------|
| YZ250, WR250 | 91 | O-Ring | C7089 | \$35.72 | R110X2B | Outer Head O-ring | \$2.86 | 93211-11770-00 | | | | | |
| | | | | | R76X2V | Inner Head O-ring | \$3.64 | 93210-77363-00 | | | | | |
| | | | | | B0062018AFM | Base Gasket | \$6.25 | 2VM-11351-10-00 | | | | | |
| | | | | | B0062012F | High Compression Base Gasket | \$9.32 | 2VM-11351-10-00 | | | | | |
| | | | | | IR017020F | Intake Gasket | \$3.80 | 8CH/8DF-13621-00 | | | | | |
| | | | | | PV036018AFM | Left Side Power Valve | \$3.80 | 3JE-1131N-10-00 | | | | | |
| | | | | | PV038018AFM | Right Side Power Valve Gasket | \$3.80 | 3SP-11993-10-00 | | | | | |
| | | | | | R228V | Exhaust O-ring | \$3.92 | 93210-56743-00 | | | | | |
| | | | | | Crank Seal Kit | List Price | Component Part# | Component Description | List Price | OEM Part # | | | |
| | | | | | C7669 | \$12.78 | OS118 | Left Crank Seal 21X40X7 | \$7.10 | 93102-22363-00 | | | |
| | | | | | | | OS119 | Right Crank Seal 34X55X10 | \$7.10 | 93103-40091-00 | | | |
| | | | | | | | Component Part# | Component Description | List Price | OEM Part # | | | |
| | | | | | | | C7488 | Clutch Cover | \$7.66 | 3SP-15463-11-00 | | | |
| YZ250, WR250 | 92-94 | O-Ring | C7113 | \$35.72 | R110X2B | Outer Head O-ring | \$2.86 | 93211-11770-00 | | | | | |
| | | | | | R76X2V | Inner Head O-ring | \$3.64 | 93210-77363-00 | | | | | |
| | | | | | B0062018AFM | Base Gasket | \$6.25 | 2VM-11351-10-00 | | | | | |
| | | | | | B0062012F | High Compression Base Gasket | \$9.32 | 2VM-11351-10-00 | | | | | |
| | | | | | IR017020F | Intake Gasket | \$3.80 | 8CH/8DF-13621-00 | | | | | |
| | | | | | PV036018AFM | Left Side Power Valve | \$3.80 | 3JE-1131N-10-00 | | | | | |
| | | | | | PV038018AFM | Right Side Power Valve Gasket | \$3.80 | 3SP-11993-10-00 | | | | | |
| | | | | | R228V | Exhaust O-ring | \$3.92 | 93210-56743-00 | | | | | |
| | | | | | Bottom End Kit w/crank seals | List Price | Component Part# | Component Description | List Price | OEM Part # | | | |
| | | | | | C3300 | \$28.50 | C7488 | Clutch Cover | \$7.66 | 3SP-15463-11-00 | | | |
| | | | | | | | EC253060AFM | Mag Cover Gasket | \$5.00 | 2VM-15462-10-00 | | | |
| | | | | | | | EC254020F | Crankcase Gasket | \$5.00 | 2VM-15462-10-00 | | | |
| | | | | | | | WP044018AFM | Water Pump Gasket | \$3.74 | 2VM-12428-11-00 | | | |
| | | | | | Clutch & Mag Kit | List Price | Component Part# | Component Description | List Price | OEM Part # | | | |
| | | | | | C7113CM | \$12.66 | C7488 | Clutch Cover | \$7.66 | 3SP-15463-11-00 | | | |
| | | | | | | | EC253060AFM | Mag Cover Gasket | \$5.00 | 2VM-15462-10-00 | | | |
| | | | | | Crank Seal Kit | List Price | Component Part# | Component Description | List Price | OEM # | | | |
| | | | | | C7669 | \$12.78 | OS118 | Left Crank Seal 21X40X7 | \$7.10 | 93102-22363-00 | | | |
| | | | | | | | OS119 | Right Crank Seal 34X55X10 | \$7.10 | 93103-40091-00 | | | |
| | | | | | YZ250 | 95-96 | O-Ring | C7250 | \$35.72 | R110X2B | Outer Head O-ring | \$2.86 | 93211-11770-00 |
| | | | | | | | | | | R76X2V | Inner Head O-ring | \$3.64 | 93210-77363-00 |
| B0062018AFM | Base Gasket | \$6.25 | 2VM-11351-10-00 | | | | | | | | | | |
| B0062012F | High Compression Base Gasket | \$9.32 | 2VM-11351-10-00 | | | | | | | | | | |
| IR017020F | Intake Gasket | \$3.80 | 8CH/8DF-13621-00 | | | | | | | | | | |
| PV036018AFM | Left Side Power Valve | \$3.80 | 3JE-1131N-10-00 | | | | | | | | | | |
| PV038018AFM | Right Side Power Valve Gasket | \$3.80 | 3SP-11993-10-00 | | | | | | | | | | |
| PV045018AFM | Left side PV | \$3.80 | 4MX-11354-00 | | | | | | | | | | |
| R224V | Exhaust O-ring | \$1.19 | 93210-472A9-00 | | | | | | | | | | |
| Bottom End Kit w/crank seals | List Price | Component Part# | Component Description | List Price | | | | | | OEM Part # | | | |
| C3300 | \$28.50 | C7488 | Clutch Cover | \$7.66 | | | | | | 3SP-15463-11-00 | | | |
| | | EC253060AFM | Mag Cover Gasket | \$5.00 | | | | | | 2VM-15462-10-00 | | | |
| | | EC254020F | Crankcase Gasket | \$5.00 | | | | | | 2VM-15462-10-00 | | | |
| | | WP044018AFM | Water Pump Gasket | \$3.74 | | | | | | 2VM-12428-11-00 | | | |
| Clutch & Mag Kit | List Price | Component Part# | Component Description | List Price | | | | | | OEM Part # | | | |
| C7113CM | \$12.66 | C7488 | Clutch Cover | \$7.66 | | | | | | 3SP-15463-11-00 | | | |
| | | EC253060AFM | Mag Cover Gasket | \$5.00 | | | | | | 2VM-15462-10-00 | | | |
| Crank Seal Kit | List Price | Component Part# | Component Description | List Price | | | | | | OEM # | | | |
| C7669 | \$12.78 | OS118 | Left Crank Seal 21X40X7 | \$7.10 | | | | | | 93102-22363-00 | | | |
| | | OS119 | Right Crank Seal 34X55X10 | \$7.10 | | | | | | 93103-40091-00 | | | |



MX/Dirt · Off-Road · ATV Gaskets



Cometic Gasket - An Exclusive NASCAR Performance® Product

YAMAHA

| Model | Year | Bore Size | Top End Kit | List Price | Component Part# | Component Description | List Price | OEM Part # | | | | | |
|--|-------------------------------|-----------|-----------------------------|------------|-------------------------------------|-----------------------------------|-------------------|------------------------|------------------------------|------------------------------|------------------------------|-------------------|-------------------|
| YZ250 | 97-98 | O-Ring | C7337 | \$35.72 | R110X2B | Outer Head O-ring | \$2.86 | 93211-11770-00 | | | | | |
| | | | | | R76X2V | Inner Head O-ring | \$3.64 | 93210-77363-00 | | | | | |
| | | | | | B0272018AFM | Base Gasket .018" AFM | \$6.25 | | | | | | |
| | | | | | B0272012F | High Compression Base Gasket | \$9.32 | | | | | | |
| | | | | | IR017020F | Intake Gasket | \$3.80 | 8CH/8DF-13621-00 | | | | | |
| | | | | | R224V | Exhaust O-ring | \$1.19 | 93210-472A9-00 | | | | | |
| | | | | | PV036018AFM | Left Side Power Valve | \$3.80 | 3JE-1131N-10-00 | | | | | |
| | | | | | PV038018AFM | Right Side Power Valve Gasket | \$3.80 | 3SP-11993-10-00 | | | | | |
| | | | | | PV045018AFM | Left side PV | \$3.80 | 4MX-11354-00 | | | | | |
| | | | | | Bottom End Kit w/crank seals | | | | List Price | Component Part# | Component Description | List Price | OEM Part # |
| | | | | | C3300 | | | | \$28.50 | C7488 | Clutch Cover | \$7.66 | 3SP-15463-11-00 |
| | | | | | | | | | | EC253060AFM | Mag Cover Gasket | \$5.00 | 2VM-15462-10-00 |
| | | | | | | | | | | EC254020F | Crankcase Gasket | \$5.00 | 2VM-15462-10-00 |
| | | | | | | | | WP044018AFM | Water Pump | \$3.74 | 2VM-12428-11-00 | | |
| | | | Clutch & Mag Kit | | | | List Price | Component Part# | Component Description | List Price | OEM Part # | | |
| | | | C7113CM | | | | \$12.66 | C7488 | Clutch Cover | \$7.66 | 3SP-15463-11-00 | | |
| | | | | | | | | EC253060AFM | Mag Cover Gasket | \$5.00 | 2VM-15462-10-00 | | |
| | | | Crank Seal Kit | | | | List Price | Component Part# | Component Description | List Price | OEM Part # | | |
| | | | C7669 | | | | \$12.78 | OS118 | Left Crank Seal 21X40X7 | \$7.10 | 93102-22363-00 | | |
| | | | | | | | | OS119 | Right Crank Seal 34X55X10 | \$7.10 | 93103-40091-00 | | |
| | | | YZ250 | 99-01 | O-Ring | C7507 | \$35.72 | R101X2B | Outer Head O-ring | \$2.14 | 93211-02703-00 | | |
| | | | | | | | | R73X2V | Inner Head O-ring | \$3.71 | 93210-74316-00 | | |
| B0372032AFM | Base Gasket | \$7.44 | | | | | | 5CU-11351-00 | | | | | |
| B0372012F | High Compression Base Gasket | \$9.94 | | | | | | | | | | | |
| PV082018AFM | Right Side Power Valve Gasket | \$7.44 | | | | | | 5CU-11993-00 | | | | | |
| PV083018AFM | Front Power Valve Gasket | \$7.44 | | | | | | 5CU-11354-00 | | | | | |
| R016B | Power Valve Governor O-ring | \$0.74 | | | | | | 93210-15639-00 | | | | | |
| R54X3V | Exhaust Gasket 2-Req. | \$3.57 | | | | | | 93210-53638-00 | | | | | |
| Top End Kit | | | | | | | | List Price | Component Part# | Component Description | List Price | OEM Part # | |
| C7855 | | | | | | | | \$38.33 | R101X2B | Outer Head O-ring | \$2.14 | 93211-02703-00 | |
| | | | | | R73X2V | Inner Head O-ring | \$3.71 | 93210-74316-00 | | | | | |
| | | | | | B0372032AFM | Base Gasket | \$7.44 | 5CU-11351-00 | | | | | |
| | | | | | B0372018AFM | High Compression Base Gasket | \$7.44 | | | | | | |
| | | | | | PV082018AFM | Right Side Power Valve Gasket | \$7.44 | 5CU-11993-00 | | | | | |
| | | | | | PV083018AFM | Front Power Valve Gasket | \$7.44 | 5CU-11354-00 | | | | | |
| | | | | | R016B | Power Valve Governor O-ring | \$0.74 | 93210-15639-00 | | | | | |
| | | | | | R54X3V | Exhaust Gasket 2-Req. | \$3.57 | 93210-53638-00 | | | | | |
| | | | | | IR114018AFM | Intake Gasket | \$3.80 | 5NX-13622-00 | | | | | |
| YZ250 72mm Bore Kits w/Head Gasket | 02-16 | 72mm | C3592 | \$49.40 | H0873SP2020S | Cylinder Head Gasket 72mm Bore | \$49.40 | | | | | | |
| | | | | | B0372032AFM | Base Gasket | \$7.44 | 5CU-11351-00 | | | | | |
| | | | | | PV082018AFM | Right Side Power Valve Gasket | \$7.44 | 5CU-11993-00 | | | | | |
| | | | | | PV083018AFM | Front Power Valve Gasket | \$7.44 | 5CU-11354-00 | | | | | |
| | | | | | R016B | Power Valve Governor O-ring | \$0.74 | 93210-15639-00 | | | | | |
| | | | | | R54X3V | Exhaust Gasket 2-Req. | \$3.57 | 93210-53638-00 | | | | | |
| | | | | | IR114018AFM | Intake Gasket | \$3.80 | 5NX-13622-00 | | | | | |
| | | | | | Top End Kit | | | | List Price | Component Part# | Component Description | List Price | OEM Part # |



MX/Dirt • Off-Road • ATV Gaskets



Cometic Gasket - An Exclusive NASCAR Performance® Product

YAMAHA

| Model | Year | Bore Size | Bottom End Kit w/Oil Seals | List Price | Component Part# | Component Description | List Price # | OEM Part # | | |
|-------|-------|-----------------------------|----------------------------|------------------------|------------------------------|------------------------------|------------------------|------------------------------|---------------------|-------------------|
| YZ250 | 99-16 | O-Ring | C7507BE | \$74.14 | R127V | Crank Case Coolant Seal | \$3.92 | 5CU-15454-00-00 | | |
| | | | | | EC300032AFM | Inner Clutch Cover | \$7.44 | 5CU-15462-00-00 | | |
| | | | | | WP068018AFM | Water Pump Cover Gasket | \$7.44 | 5XF-12428-00-00 | | |
| | | | | | WA133 | Clutch Pushrod Retainer Seal | \$0.90 | 90430-05242-00 | | |
| | | | | | WA080043C | Water Pump Drain Washer | \$0.57 | 90430-06014-00 | | |
| | | | | | WA080043C | Water Pump Drain Plug Gasket | \$0.57 | 90430-06014-00 | | |
| | | | | | WA114 | Drain Plug Gasket | \$3.02 | 90430-12207-00 | | |
| | | | | | R117B | Fill Plug O-ring | \$0.42 | 93210-19123-00 | | |
| | | | | | R12X2V | Output Shaft O-ring | \$4.09 | 93210-22298-00 | | |
| | | | | | Oil Seal Kit | List Price | Component Part# | Component Description | List Price # | OEM Part # |
| | | | | | C7507OS | \$33.45 | OS227 | Inner Water Pump Seal | \$2.67 | 93102-12321-00 |
| | | | | | | | OS286 | Clutch Pushrod Seal | \$4.29 | 93102-12224-00 |
| | | | | | | | OS286 | Shift Shaft Seal | \$4.29 | 93102-12224-00 |
| | | | | | | | OS323 | Start Shaft Seal | \$4.46 | 93102-18278-00 |
| | | OS110 | Left Crank Seal | \$9.47 | 93102-20485-00 | | | | | |
| | | OS184 | Right Crank Seal | \$11.87 | 93102-28004-00 | | | | | |
| | | OS119 | Right Crank Seal 99-00 | \$7.10 | 93103-36182-00 | | | | | |
| | | OS242 | Outer Water Pump Seal | \$2.67 | 93109-11073-00 | | | | | |
| | | OS284 | Output Shaft Seal | \$5.09 | 93102-32M07-00 | | | | | |
| | | Clutch & Mag Kit | List Price | Component Part# | Component Description | List Price | OEM Part # | | | |
| | | C7507CM | \$16.35 | C7528 | Clutch Cover Gasket | \$8.91 | 5CU-15463-00 | | | |
| | | | | EC299060AFM | Mag Cover Gasket | \$7.44 | 5CU-15451-00 | | | |
| YZ250 | 99-01 | O-Ring | Crank Seal Kit | List Price | Component Part# | Component Description | List Price | OEM Part # | | |
| | | | C7670 | \$12.78 | OS119 | Right Crank Seal 34X55X10 | \$7.10 | 93103-40091-00 | | |
| YZ250 | 02-14 | O-Ring | Crank Seal Kit | List Price | Component Part# | Component Description | List Price | OEM Part # | | |
| | | | C7803 | \$14.38 | OS110 | Left Crank Seal 20X40X7 | \$9.47 | 93102-20485-00 | | |
| | | | | | OS184 | Right Crank Seal 26X55X10 | \$11.87 | 93102-28004-00 | | |
| | | | | | OS110 | Left Crank Seal 20X40X7 | \$9.47 | 93102-20485-00 | | |

TTR250

| Model | Year | Bore Size | Top End Kit | List Price | Component Part# | Component Description | List Price | OEM Part # |
|--------|-------|-----------|-------------|------------|-----------------|---------------------------|------------|-----------------|
| TTR250 | 99-06 | 75 mm | C7726 | \$34.47 | H0461043F | Head Gasket | \$24.75 | 4GY-11181-01-00 |
| | | 83 mm | C7340 | \$34.47 | H0461SP1043F | Big Bore Head Gasket 83mm | \$24.75 | |
| | | | | | B0391020F | Base Gasket | \$6.19 | 4GY-11351-00-00 |
| | | | | | B0391SP1020F | Big Bore Base Gasket | \$8.69 | |
| | | | | | EC353020F | Clutch Cover Gasket | \$9.94 | 4GY-15461-00-00 |



MX/Dirt · Off-Road · ATV Gaskets



Cometic Gasket - An Exclusive NASCAR Performance® Product

WR250F

| Model | Year | Bore Size | Top End Kit | List Price | Component Part# | Component Description | List Price | OEM Part # |
|--------|-------|-----------|-------------|------------|-----------------|----------------------------|------------|-----------------|
| WR250F | 01-13 | 77 mm | C7905-EST | \$68.59 | H1168SP3027S | Head Gasket | \$31.15 | 5NL-11181-00-00 |
| | | 79 mm | C3057-EST | \$68.59 | H1168SP2027S | Head Gasket 79mm Bore | \$31.15 | |
| | | 81 mm | C3059-EST | \$68.59 | H1271027S | Head Gasket 81mm Bore | \$31.15 | |
| | | 83 mm | C3061-EST | \$68.59 | H1272SP3027S | Head Gasket 84mm Bore | \$31.15 | |
| | | 84 mm | C3120-EST | \$68.59 | B0503020RC | Base Gasket | \$13.74 | 5NL-11351-00-00 |
| | | | | | EX651 | Exhaust Gasket | \$8.98 | 5NL-14613-00-00 |
| | | | | | EC019032AFM | AFM Cam Chain Tens. Gasket | \$2.04 | 4FM-12213-00 |
| | | | | | 3179V | Exhaust Valve Seal 2 Req. | \$5.50 ea. | 4SV-12119-00-00 |
| | | | | | 3233V | Intake Valve Seal 3 Req. | \$5.11 ea. | 4TV-12119-00-00 |

| Bottom End Kit w/Oil Seals | List Price | Component Part# | Component Description | List Price # | OEM Part # |
|----------------------------|------------|-----------------|--------------------------------|--------------|---------------------------------|
| C3561BE | \$77.84 | EC554032AFM | Inner Clutch Cover Gasket | \$9.94 | 5NL-15462-00-00 |
| | | R011B | Oil Delivery Pipe O-Ring (SM) | \$1.13 | 93210-07003-00/07540-00 |
| | | R013B | Oil Delivery Pipe O-Ring (3) | \$1.19 | 93210-10197-00 |
| | | R014B | Oil Delivery Pipe O-Ring (LG) | \$0.40 | 93210-12759-00 |
| | | R016B | Base and Case Dowel O-ring | \$0.74 | 93210-16716-00 / 93210-16772-00 |
| | | R109B | Oil Filter O-Ring (SM) (2) | \$1.13 | 93210-07135-00 |
| | | R10X2V | Center Case Dowel O-ring | \$1.59 | 93210-10197-00* |
| | | R113B | Timing Mark Plug O-Ring | \$1.19 | 93210-14369-00 |
| | | R120V | Electric Starter O-ring | \$1.25 | 93210-25711-00 |
| | | R121V | Crank End Plug O-ring | \$1.25 | 93210-27370-00/93210-27778-00 |
| | | R134B | Oil Filter O-Ring | \$1.13 | 93210-47675-00 |
| | | R19X2V | Oil Fill Plug O-ring | \$2.50 | 93210-19123-00 |
| | | R141SB | Starter Gear O-ring | \$18.99 | 93210-60426-00 |
| | | R903B | Oil Delivery Pipe O-Ring (MED) | \$6.35 | 93210-09008-00 |
| | | WA080043C | Water Pump Drain Washer | \$0.57 | 90430-06014-00 |
| | | WA082063C | Oil Line Crush Washer (2) | \$1.93 | 90430-10188-00 |
| | | WA082063C | Oil Drain Bolt Washer | \$1.93 | 90430-10188-00*/10171-00 |
| | | WA116 | Oil Line Crush Washer (2) | \$3.02 | 90430-08119-00 |
| | | WP297 | Water Pump Cover O-ring | \$5.19 | 5NL-12439-00-00 |
| | | R116B | Kickstart O-ring | \$1.13 | 93210-17570-00 |

| Oil Seal Kit | List Price | Component Part# | Component Description | List Price # | OEM Part # |
|--------------|------------|-----------------|-------------------------|--------------|----------------|
| C3561OS | \$30.91 | OS227 | Inner Water Pump Seal | \$2.67 | 93102-12321-00 |
| | | OS236 | Oil Pump Seal | \$4.23 | 93101-14164-00 |
| | | OS283 | Outer Water Pump Seal | \$4.34 | 93109-11073-00 |
| | | OS286 | Shift Shaft Seal | \$4.29 | 93102-12224-00 |
| | | OS286 | Hot Start Mech Oil Seal | \$4.29 | 93102-12224-00 |
| | | OS323 | Start Shaft Seal | \$4.46 | 93102-18278-00 |
| | | OS324 | Output Shaft Seal | \$6.63 | 93102-28010-00 |

| Clutch & Mag Kit | List Price | Component Part# | Component Description | List Price | OEM Part # |
|------------------|------------|-----------------|---------------------------|------------|-----------------|
| C3561CM | \$12.09 | EC553032AFM | Outer Clutch Cover Gasket | \$4.65 | 5NL-15453-10-00 |
| | | EC1931032AFM | Mag Cover Gasket | \$7.44 | 5UM-15451-00-00 |



MX/Dirt • Off-Road • ATV Gaskets



Cometic Gasket - An Exclusive NASCAR Performance® Product

YAMAHA

| Model | Year | Bore Size | Top End Kit | List Price | Component Part# | Component Description | List Price | OEM Part # |
|-----------------------------|-------|-----------------------------------|----------------|-------------------|------------------------|----------------------------------|---------------------|--------------------------|
| YZ250F | 01-13 | 77 mm | C7905-EST | \$68.59 | H1168SP3027S | Head Gasket | \$31.15 | 5NL-11181-00-00 |
| | | 79 mm | C3057-EST | \$68.59 | H1168SP2027S | Head Gasket 79mm Bore | \$31.15 | |
| | | 81 mm | C3059-EST | \$68.59 | H1271027S | Head Gasket 81mm Bore | \$31.15 | |
| | | 83 mm | C3061-EST | \$68.59 | H1272SP3027S | Head Gasket 84mm Bore | \$31.15 | |
| | | 84 mm | C3120-EST | \$68.59 | B0503020RC | Base Gasket | \$13.74 | 5NL-11351-00-00 |
| | | | | | EX651 | Exhaust Gasket | \$8.98 | 5NL-14613-00-00 |
| | | | | | EC019032AFM | AFM Cam Chain Tens. Gasket | \$2.04 | 4FM-12213-00 |
| | | | | | 3179V | Exhaust Valve Seal 2 Req. | \$5.50 ea. | 4SV-12119-00-00 |
| | | | | | 3233V | Intake Valve Seal 3 Req. | \$5.11 ea. | 4TV-12119-00-00 |
| | | Bottom End Kit w/Oil Seals | | | | | | |
| | | | C3057BE | \$74.14 | EC554032AFM | Inner Clutch Cover Gasket | \$9.94 | 5NL-15462-00-00 |
| | | | | | R011B | Oil Delivery O-ring (SM) | \$1.08 | 93210-07003-00/07540-00 |
| | | | | | R013B | Oil Pump Seal O-Ring | \$1.19 | 93210-10197-00* |
| | | | | | R013B | Clutch Side Oil Feed Line O-Ring | \$1.19 | 93210-10197-00* |
| | | | | | R013B | Mag Side Oil Feed Line O-Ring | \$1.19 | 93210-10197-00* |
| | | | | | R014B | Oil Delivery Pipe O-Ring (Lg.) | \$1.08 | 93210-12759-00 |
| | | | | | R016V | Case Dowel O-ring | \$1.19 | 93210-16772-00 |
| | | | | | R109B | Oil Filter Cover O-Ring (Sm.) | \$1.13 | 93210-07135-00 |
| | | | | | R10X2V | Centercase Dowel O-ring | \$1.59 | 93210-10197-00* |
| | | | | | R113B | Timing Plug O-ring | \$1.19 | 93210-14369-00 |
| | | | | | R124B | Crank End Plug O-ring | \$3.92 | 93210-32172-00 |
| | | | | | R134B | Oil Filter O-Ring (LG) | \$1.13 | 93210-47675-00 |
| | | | | | R19X2V | Oil Fill Plug O-ring | \$2.50 | 93210-19123-00 |
| | | | | | R903V | Oil Delivery Pipe O-ring (Med.) | \$1.19 | 93210-09008-00 |
| | | | | | WA080043C | Coolant Drain Bolt Washer | \$0.57 | 90430-06014-00* |
| | | | | | WA082063C | Oil Drain Bolt Washer | \$1.93 | 90430-10188-00*/10171-00 |
| | | | | | WP297 | Water Pump O-Ring | \$5.19 | 5NL-12439-00-00 |
| Oil Seal Kit | | | | List Price | Component Part# | Component Description | List Price # | OEM Part # |
| | | | C3057OS | \$33.45 | OS323 | Kick Start Shaft Seal | \$4.46 | 93102-18278-00 |
| | | | | | OS324 | Countershaft Oil Seal | \$6.63 | 93102-28010-00 |
| | | | | | OS283 | Outer Water Pump Seal | \$4.34 | 93109-11073-00 |
| | | | | | OS227 | Inner Water Pump Seal | \$5.21 | 93102-12106-00 |
| | | | | | OS236 | Oil Pump Seal | \$4.23 | 93101-14164-00 |
| | | | | | OS286 | Gear Selector Seal | \$4.29 | 93102-12224-00 |
| Clutch & Mag Kit | | | | List Price | Component Part# | Component Description | List Price | OEM Part # |
| | | | C3057CM | \$12.09 | EC553032AFM | Clutch Cover Gasket | \$4.65 | 5NL-15453-00-00 |
| | | | | | EC527060AFM | Mag. Cover Gasket | \$7.44 | 5NL-15451-00-00 |
| | | | | | Component Part# | Component Description | List Price | OEM Part # |
| | | | | | VC103 | Valve Cover Gasket | \$17.80 | |



MX/Dirt · Off-Road · ATV Gaskets



Cometic Gasket - An Exclusive NASCAR Performance® Product

YAMAHA

| Model | Year | Bore Size | Top End Kit | List Price | Component Part# | Component Description | List Price | OEM Part # |
|--------|-------|-----------|-------------|------------|-----------------|--------------------------------|------------|-----------------|
| YZ250F | 14-16 | 77mm | C3549-EST | \$61.00 | H3885027S | Head Gasket 77mm Bore | \$29.77 | 1SM-11181-00-00 |
| | | 80mm | C3550-EST | \$61.00 | H3885SP4027S | Head Gasket 80mm Bore | \$29.77 | |
| | | | | | B1236010RC | Base Gasket | \$12.69 | 1SM-11351-00-00 |
| | | | | | EX651 | Exhaust Gasket | \$8.98 | 5NL-14613-00-00 |
| | | | | | EC019032AFM | Cam Chain Tensioner Gasket | \$2.04 | 4FM-12213-00-00 |
| | | | | | 3239V | Exhaust Valve Stem Seal 2 req. | \$5.50 | 4TE-12119-00-00 |
| | | | | | 3234V | Intake Valve Stem Seal 2 req. | \$5.50 | 33M-12119-00-00 |
| | | | | | WA114 | Cylinder Head Drain Seal | \$3.02 | 90430-06014-00 |
| | | | | | WA140 | Cam Chain Tens. Crush Seal | \$0.63 | 5EL-12214-00-00 |
| | | | | | R020V | TPS O-ring | \$1.19 | 1DX-14562-00-00 |

| Bottom End Kit w/Oil Seals | List Price | Component Part# | Component Description | List Price # | OEM Part # |
|----------------------------|------------|-----------------|--------------------------------|--------------|-----------------|
| C3549BE | \$74.14 | WA082063C | Case Drain Crush Washer | \$1.93 | 90430-10188-00 |
| | | R117B | Fill Plug O-ring | \$0.42 | 93210-19123-00 |
| | | R13.5X2V | Timing Mark O-ring | \$1.93 | 93210-14369-00 |
| | | R127V | Timing Plug O-ring | \$3.92 | 93210-357A3-00 |
| | | R115V | Water Pump Coolant Elb. O-ring | \$1.13 | 93210-16500-00 |
| | | R116B | Kickstart O-ring | \$1.13 | 93210-17570-00 |
| | | R016V | Case Water Pipe O-ring | \$1.19 | 93210-16716-00 |
| | | | | | 93210-16772-00 |
| | | WA080043C | Water Pump Drain Plug | \$0.57 | 90430-06014-00 |
| | | EC1935032AFM | Inner Clutch Cover Gasket | \$9.94 | 1SM-15462-00-00 |
| | | R013V | Oil Filter O-ring | \$2.34 | 93210-45708-00 |
| | | R014V | Oil Pump O-ring | \$1.08 | 93210-12010-00 |
| | | R014V | Coolant Elbow O-ring | \$1.08 | 93210-16275-00 |
| | | WP439032AFM | Water Pump Gasket | \$10.61 | 33D-12427-00-00 |

| Oil Seal Kit | List Price | Component Part# | Component Description | List Price # | OEM Part # |
|--------------|------------|-----------------|-----------------------|--------------|----------------|
| C3549OS | \$33.45 | OS236 | Water Pump Oil Seal | \$4.23 | 93101-14164-00 |
| | | OS323 | Start Shaft Seal | \$4.46 | 93102-18278-00 |
| | | OS229 | Clutch Actuator Seal | \$1.99 | 93102-10008-00 |
| | | OS197 | Shift Shaft Seal | \$2.46 | 93109-14010-00 |
| | | OS235 | Output Shaft Seal | \$6.85 | 93102-28012-00 |
| | | OS308 | Outer Water Pump Seal | \$2.95 | 93102-08004-00 |
| | | OS233 | Inner Water Pump Seal | \$3.62 | 93102-08307-00 |

| Clutch & Mag Kit | List Price | Component Part# | Component Description | List Price | OEM Part # |
|------------------|------------|-----------------|---------------------------|------------|-----------------|
| C3549CM | \$12.04 | EC1941032AFM | Outer Clutch Cover Gasket | \$7.04 | 1SM-15453-00-00 |
| | | EC1942032AFM | Mag Cover Gasket | \$5.00 | 1SM-15451-00-00 |

TRiZ250

| Model | Year | Bore Size | Top End Kit | List Price | Component Part# | Component Description | List Price | OEM Part # |
|---------------------------------|-------|-----------|-------------|------------|-----------------|-----------------------|------------|-----------------|
| TriZ250 Tri Moto | 85-86 | 71 mm | C7153 | \$35.72 | H0269043F | Head Gasket | \$24.75 | 38W-11181-00-00 |
| | | | | | B0172020F | Base Gasket | \$6.25 | 39X-11351-01-00 |
| | | | | | IR017020F | Intake Gasket | \$3.80 | 80L-13621-01-00 |
| YFA250 Breeze | 89-95 | 50 mm | C7255 | \$35.71 | H0312043F | Head Gasket | \$17.38 | 3GH-11181-00-00 |
| | | | | | B0187020F | Base Gasket | \$4.65 | 3FA-11351-10-00 |
| YFM250 Timberwolf 2WD/4WD | 92-03 | 72 mm | C7254 | \$35.72 | H0066043F | Head Gasket | \$19.82 | 59V-11181-00-00 |
| | | | | | B0067020F | Base Gasket | \$5.34 | 4BD-11351-00-00 |
| YFM250 Moto-4 | 89-91 | 71 mm | C7256 | \$35.72 | H0066043F | Head Gasket | \$19.82 | 59V-11181-00-00 |
| | | | | | B0067020F | Base Gasket | \$5.34 | 4BD-11351-00-00 |



MX/Dirt · Off-Road · ATV Gaskets



Cometic Gasket - An Exclusive NASCAR Performance® Product

YFM250R

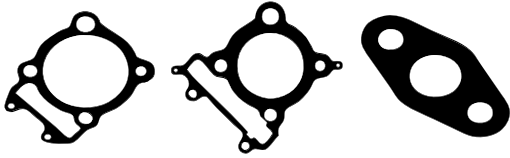

| Model | Year | Base Bore Size | Head Bore Size | Head Block OffPlate EST | List Price | Component Part# | List Price | OEM Part # |
|---------|-------|----------------|----------------|-------------------------|------------|--|------------|-----------------|
| | | | | Top End Kit | | | | |
| YFM250R | 08-13 | 74 mm | | C3223-EST | \$76.70 | H2760040S Head Gasket | \$31.15 | 5XT-11181-00-00 |
| Raptor | | 76 mm | | C3224-EST | \$76.70 | H2760SP2040S Head Gasket 76mm | \$31.15 | 5XT-11181-00-00 |
| | | 78 mm | | C3225-EST | \$76.70 | H2760SP3040S Head Gasket 78mm | \$31.15 | 5XT-11181-00-00 |
| | | 80mm | | C3226-EST | \$76.70 | H2760SP1040S Head Gasket 80mm | \$31.15 | 5XT-11181-00-00 |
| | | 81mm | | C3236-EST | \$76.70 | H2760SP5040S Head Gasket 81mm | \$31.15 | 5XT-11181-00-00 |
| | | | | | | B0936020RC Base Gasket | \$11.81 | 4D3-11351-00-00 |
| | | | | | | EX817 Exhaust Gasket | \$11.28 | 3GD-14613-00 |
| | | | | | | EC019018AFM Cam Chain Tensioner Gasket | \$2.04 | 4FM-12213-00 |
| | | | | | | EC1230032AFM Head Block Off Plate Gasket | \$1.13 | 5XT-14815-00-00 |
| | | | | | | R013B Cam O-ring | \$1.19 | 93210-11453-00 |
| | | | | | | R046B Cam Gear Cover O-ring | \$11.34 | 93211-05471-00 |
| | | | | | | R127V Intake O-Ring Seal | \$3.92 | 5PA-14642-00-00 |

XT350

| Model | Year | Bore Size | Top End Kit | List Price | Component Part# | Component Description | List Price | OEM Part # |
|-------|-------|-----------|-------------|------------|-----------------|-----------------------|------------|-----------------|
| XT350 | 85-99 | 87.5 mm | C7530 | \$21.76 | H0836043F | Head Gasket | \$14.87 | 55V-11181-00-00 |
| | | | | | B0388020F | Base Gasket | \$6.19 | 4DR-11351-00 |

YFZ350

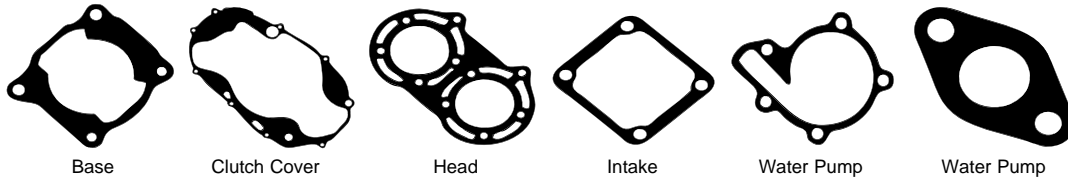

| Model | Year | Base Bore Size | Clutch Cover Bore Size | Head Bore Size | Top End Kit | List Price | Intake Component Part# | Water Pump Component Part# | Water Pump Component Description | List Price | OEM Part # |
|---------|-------|----------------|------------------------|----------------|-------------|------------|------------------------|----------------------------|----------------------------------|------------|-----------------|
| YFZ350 | 87-05 | 65.5 mm | | | C7094 | \$31.91 | H0275010S | | Head Gasket 65.5 mm Bore | \$22.37 | 2GU-11181-00-00 |
| Banshee | | 66.5 mm | | | C7275 | \$31.91 | H0311010S | | Head Gasket 66.5mm Bore | \$22.37 | 2GU-11181-00-00 |
| | | 68 mm | | | C7316 | \$31.91 | H0442010S | | Head Gasket 68mm | \$22.37 | 2GU-11181-00-00 |
| | | 69.5 mm | | | C7710 | \$31.91 | H0745010S | | Head Gasket 69.5mm Bore | \$22.37 | 2GU-11181-00-00 |
| | | 71 mm | | | C7607 | \$31.91 | H0418010S | | Head Gasket 71mm Bore | \$22.37 | 2GU-11181-00-00 |
| | | | | | | | B0066012F | | High Comp. Base Gasket 2 Req. | \$9.32 | 3GG-11351-00-00 |
| | | | | | | | B0066018AFM | | Base Gasket 2 Req. | \$9.32 | 3GG-11351-00-00 |
| | | | | | | | IR019018AFM | | Intake Gasket 2 Req. | \$3.80 | 55K-13621-00-00 |
| | | | | | | | R224V | | Exhaust O-Ring 2 Req. | \$1.19 | 93210-45742-00 |
| | | | | | | | WP118032AFM | | Water Outlet Gasket | \$2.61 | 3XV-12435-00-00 |

| Bottom End Kit w/Oil Seals | List Price | Component Part# | Component Description | List Price # | OEM Part # |
|----------------------------|------------|-----------------|--------------------------------|--------------|-------------------------------|
| C7094BE | \$86.17 | WP072020F | Water Pump Cover Gasket | \$6.25 | 3GG-12428-01-00 |
| | | R19X2V | Oil Fill Plug O-ring | \$1.99 | 93210-19123-00 |
| | | EC318020F | Inner Clutch Cover Gasket | \$10.91 | 3GG-15461-02-00 |
| | | WA120 | Drain Plug Gasket | \$.83 | 90430-14043-00 |
| Oil Seal Kit | List Price | Component Part# | Component Description | List Price # | OEM Part # |
| C7094OS | \$56.56 | OS126 | Right Crank Seal 23x40x10 | \$11.87 | 93103-40077-00 |
| Crank Seal Kit | List Price | OS125 | Right Crank Seal 38X62X12 | \$9.47 | 93103-40077-00 |
| C7673 | \$19.20 | OS225 | Kickstart Shaft Seal 20x30x5 | \$5.03 | 93102-20484-00 |
| | | OS226 | Impeller Shaft Seal 10x31x13.5 | \$14.11 | 93103-10147-00 |
| | | OS227 | Shift Shaft Seal 12x22x5 | \$2.67 | 93102-12106-00/93102-12321-00 |
| | | OS268 | Output Shaft Seal 35x62x6 | \$8.34 | 93102-35369-00 |
| | | OS357 | Clutch Actuator Seal 17x28x6 | \$5.07 | 93102-17004-00 |



MX/Dirt · Off-Road · ATV Gaskets



Cometic Gasket - An Exclusive NASCAR Performance® Product

YFM350 BRUIN



| Model | Year | Base Bore Size | Clutch Cover Bore Size | Mag Cover EST | Timing Chain Tensioner List Price | Head Component Part# | Head Component Description | Oil Pump List Price | OEM Part # |
|-----------------------------|-------|----------------|------------------------|---------------|-----------------------------------|----------------------|-------------------------------|---------------------|-----------------|
| YFM350 Bruin | 04-06 | 84 mm | 85 mm | C7096-EST | \$71.49 | H0067027S | Head Gasket Multi-Layer-Steel | \$31.15 | 1UY-11181-01-00 |
| YFM350 Raptor | 04-14 | | | C3159-EST | \$71.49 | H0067043F | Head Gasket Fiber | \$22.32 | 1UY-11181-01-00 |
| YFM350 Wolverine | | | | | | H0067SPA027S | Head Gasket 85mm Steel | \$31.15 | 1UY-11181-01-00 |
| YFM350 Warrior | 87-04 | | | | | B0068020F | Base Gasket | \$6.25 | 4KB-11351-00-00 |
| YFM350 400 Big Bear, Moto 4 | 95-06 | | | | | EC998032AFM | Cam Chain Tensioner Gasket | \$2.33 | 3GD-12213-00-00 |
| | | | | | | 3230V | Valve Seals 2 Req. | \$6.48 | M01-12129-00-00 |
| | | | | | | R86X3V | Cam Cover O-ring | \$6.00 | 93211-06635-00 |
| | | | | | | R57X2V | Tappet Cover O-ring 2 Req. | \$3.20 | 93210-57634-00 |
| | | | | | | R106X2V | Base O-ring | \$5.71 | 93210-86509-00 |
| | | | | | | R031B | Intake O-ring | \$4.65 | 93210-44545-00 |
| | | | | | | R012B | Base Dowel O-ring | \$0.51 | 93210-18322-00 |

| Bottom End Kit w/Oil Seals | List Price | Component Part# | Component Description | List Price # | OEM Part # |
|----------------------------|------------|-----------------|-------------------------------------|--------------|-----------------|
| C7096BE | \$83.50 | WA080043C | Case Bolt Crush Washer | \$0.57 | 90430-06014-00 |
| | | OP031020F | Oil Pump Gasket | \$18.56 | 3GD-13329-00-00 |
| | | WA080043C | Drain Plug O-ring | \$0.57 | 93210-35512-00 |
| | | WA116 | Oil Line Crush Washer | \$3.02 | 90430-08119-00 |
| | | R227V | Oil Pump Cover Gasket | \$3.92 | 93210-54175-00 |
| | | R114V | Shift Shaft O-ring | \$1.19 | 93210-15566-00 |
| | | R020V | Neutral Drum Shift Detent O-ring | \$1.19 | 90430-14194-00 |
| | | R116B | Fill Plug O-ring | \$1.13 | 93210-19522-00 |
| | | R027V | Timing Mark O-ring | \$1.19 | 93210-14369-00 |
| Oil Seal Kit | List Price | Component Part# | Component Description | List Price # | OEM Part # |
| C7096OS | \$40.88 | OS351 | Mag Oil Seal 28x52x8.2 | \$5.83 | 93102-28017-00 |
| | | OS347 | Shift Shaft Oil Seal 14x26x6 | \$4.46 | 93102-14209-00 |
| | | OS352 | Neutral Drum Oil Seal 15x25x5 | \$4.36 | 93102-15212-00 |
| | | OS348 | Output Shaft Oil Seal 35x45x6 | \$8.34 | 93102-35393-00 |
| | | OS350 | Idler Shaft Oil Seal 20x52x3.5 | \$5.83 | 93104-20068-00 |
| | | OS349 | Trans Main Shaft Oil Seal 17x40x3.5 | \$4.57 | 93104-17094-00 |
| | | OS286 | Clutch Actuator Seal 12x18x5 | \$4.29 | 93102-12224-00 |
| Clutch & Mag Kit | List Price | Component Part# | Component Description | List Price | OEM Part # |
| C7096CM | \$37.12 | EC314032AFM | Clutch Cover Gasket | \$18.56 | 3GD-15461-00-00 |
| | | EC315032AFM | Mag Cover Gasket | \$18.56 | 3GD-15451-00-00 |

YFM400



| Model | Year | Base Bore Size | Timing Chain Tensioner EST | Head List Price | Head Component Part# | Head Component Description | List Price | OEM Part # |
|-----------------------|-------|----------------|----------------------------|-----------------|----------------------|----------------------------|------------|-----------------|
| YFM400 KODIAK/GRIZZLY | 00-07 | 85.5 mm | C3213-EST | \$64.66 | H2464027S | Head Gasket | \$35.72 | 5GH-11181-00-00 |
| | | | | | B0918031F | Base Gasket | \$11.87 | 5GH-11351-00 |
| | | | | | EX130 | Exhaust Gasket | \$7.56 | 3GD-14613-00-00 |
| | | | | | EC998032AFM | Cam Chain Tensioner Gasket | \$2.33 | 3GD-12213-00-00 |
| | | | | | R012B | Rocker Arm O-ring 2 Req. | \$0.51 | 93210-09165-00 |
| | | | | | R106X2V | Cam Cover O-ring | \$5.71 | 93211-06635-00 |
| | | | | | R116V | Base Dowel O-ring | \$1.19 | 93210-18322-00 |
| | | | | | R141SB | Valve Cover O-ring | \$18.99 | 93210-57634-00 |
| | | | | | R89X2.5V | Base O-ring | \$4.43 | 93210-89447-00 |
| | | | | | 3230V | Valve Seals 2 Req. | \$6.48 | M01-12129-00-00 |
| | | | | | WA118 | Head Drain Plug Washer | \$1.88 | 90430-06014-00 |

All Component Parts can be purchased individually.



MX/Dirt · Off-Road · ATV Gaskets



Cometic Gasket - An Exclusive NASCAR Performance® Product

YZ400F

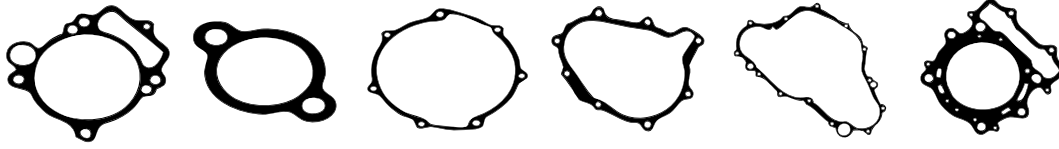

| Model | Year | Bore Size | Top End Kit | List Price | Component Part# | Component Description | List Price | OEM Part # | | |
|--------|-------|-----------|-----------------------------|-------------------|---------------------------------------|------------------------------|----------------------------|---------------------------|-----------------|--------------|
| YZ400F | 98-99 | 92 mm | C7400 | \$38.33 | H0707027S | Head Gasket | \$38.44 | 5BE-11181-00-00 | | |
| | | 94 mm | C7401 | \$38.33 | H0709027S | Head Gasket 94mm Bore | \$38.44 | | | |
| | | 95 mm | C7689 | \$38.33 | H0869027S | Head Gasket 95mm Bore | \$38.44 | | | |
| | | 97 mm | C7470 | \$38.33 | H0725027S | Head Gasket 97mm Bore | \$38.44 | | | |
| | | | | | | B0334020RC | Base Gasket | \$6.25 | 5BE-11351-00-00 | |
| | | | | | | EC019018AFM | Cam Chain Tensioner Gasket | \$2.04 | 4FM-12213-00 | |
| | | | | | Bottom End Kit w/o crank seals | | | | | |
| | | | | | C3303 | \$19.99 | C7487 | Outer Clutch Cover Gasket | \$10.22 | 5BE-15453-00 |
| | | | | | | | EC292060AFM | Mag Cover Gasket | \$6.19 | 5BE-15451-00 |
| | | | | | | | EC293032AFM | Inner Clutch Cover Gasket | \$8.69 | 5BE-15462-00 |
| | | | Clutch & Mag Kit | List Price | Component Part# | Component Description | List Price | OEM Part # | | |
| | | | C7400CM | \$16.41 | C7487 | Outer Clutch Cover Gasket | \$10.22 | 5BE-15453-00 | | |
| | | | | | EC292060AFM | Mag Cover Gasket | \$6.19 | 5BE-15451-00 | | |

YZ426F

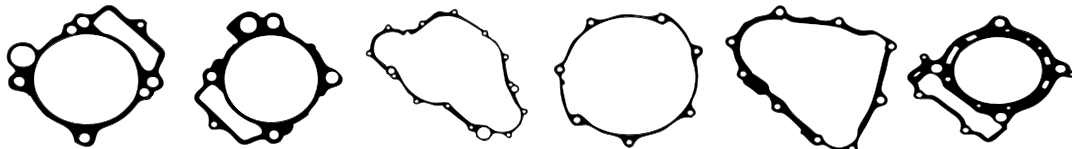

| Model | Year | Bore Size | Top End Kit | List Price | Component Part# | Component Description | List Price | OEM Part # | | |
|--------|-------|-----------|-------------|------------|---------------------------------------|-----------------------|----------------------------|------------------------------|-------------------|-------------------|
| YZ426F | 00-02 | 95 mm | C7689 | \$38.33 | H0869027S | Head Gasket 95mm Bore | \$38.44 | 5JG-11181-00-00 | | |
| | | 97 mm | C7470 | \$38.33 | H0725027S | Head Gasket 97mm Bore | \$38.44 | | | |
| | | | | | | B0334020RC | Base Gasket | \$6.25 | 5BE-11351-00-00 | |
| | | | | | | EC019018AFM | Cam Chain Tensioner Gasket | \$2.04 | 4FM-12213-00 | |
| | | | | | Bottom End Kit w/o crank seals | | | | | |
| | | | | | C3304 | \$15.62 | EC292060AFM | Mag Cover Gasket | \$6.19 | 5BE-15451-00 |
| | | | | | | | EC293032AFM | Inner Clutch Cover Gasket | \$8.69 | 5BE-15462-00 |
| | | | | | | | EC789032AFM | Clutch Cover Gasket | \$4.65 | 5JG-15453-00 |
| | | | | | Clutch & Mag Kit | List Price | Component Part# | Component Description | List Price | OEM Part # |
| | | | | | C7689CM | \$16.41 | EC292060AFM | Mag Cover Gasket | \$6.19 | 5BE-15451-00 |
| | | | | | EC789032AFM | Clutch Cover Gasket | \$4.65 | 5JG-15453-00 | | |



MX/Dirt · Off-Road · ATV Gaskets



Cometic Gasket - An Exclusive NASCAR Performance® Product

YZ450F

| Model | Year | Bore Size | EST | List Price | Component Part# | Component Description | List Price | OEM Part # | |
|--------|-------|-----------|-------------------------|------------|-----------------|----------------------------|------------|-----------------|--|
| YZ450F | 03-05 | 95 mm | Top End Kit | | | | | | |
| | | | C7947-EST | \$89.38 | H1710027S | Head Gasket | \$40.93 | 5TA-11181-00-00 | |
| | | | C3147-EST | \$89.38 | H2144027S | Head Gasket 96mm Bore | \$40.93 | | |
| | | | C3064-EST | \$89.38 | H1711027S | Head Gasket 97mm Bore | \$40.93 | | |
| | | | C3148-EST | \$89.38 | H1683027S | Head Gasket 98mm Bore | \$40.93 | | |
| | | | C3149-EST | \$89.38 | H1683SP2027S | Head Gasket 99mm Bore | \$40.93 | | |
| | | | C3117-EST | \$89.38 | H1683SPB027S | Head Gasket 100mm Bore | \$40.93 | | |
| | | | | | B0626020RC | Base Gasket | \$11.81 | 5TA-11351-00-00 | |
| | | | | | B0626SP2020RC | Base Gasket 100mm Kits | \$11.81 | | |
| | | | | | EX641 | Exhaust Gasket | \$10.96 | 3VD-14613-01-00 | |
| | | | | | EC019018AFM | Cam Chain Tensioner Gasket | \$2.04 | 4FM-12213-00 | |
| | | | | | EC019020F | Cam Chain Tensioner Gasket | \$2.04 | | |
| | | | | | WA082063C | Oil Line Washers 2 Req. | \$1.93 | 90430-10171 | |
| | | | | | 3179V | Intake Valve Seal 3 Req. | \$5.50 ea. | 4SV-12119-00-00 | |
| | | | | | 3234V | Exhaust Valve Seal 2 Req. | \$5.50 ea. | 33M-12119-00-00 | |
| | | | | | WA114 | Head Drain Washers | \$3.02 | 90430-06014 | |
| | | WA116 | Oil Line Washers 4 Req. | \$3.02 | 90201-08087-00 | | | | |

| Bottom End Kit w/Oil Seals | | List Price | Component Part# | Component Description | List Price # | OEM Part # |
|-----------------------------------|--|-------------------|------------------------|------------------------------|---------------------|-------------------|
| C7947BE | | \$75.99 | WP189 | Water Pump Cover O-ring | | 5BE-12439-00-00 |
| | | | EC762032AFM | Inner Clutch Cover | \$8.69 | 5TA-15462-00-00 |
| | | | WA080043C | Coolant Drain Gasket | \$0.57 | 90430-06014-00 |
| | | | WA080043C | Water Pump Drain Gasket | \$0.57 | 90430-06014-00 |
| | | | WA116 | Oil Line Crush Washer | \$3.02 | 90430-08119-00 |
| | | | WA082063C | Drain Plug Gasket | \$1.93 | 90430-10188-00 |
| | | | WA082063C | Oil Line Crush Washer | \$1.93 | 90430-10188-00 |
| | | | R109B | Oil Filter Cover O-rings | \$1.13 | 93210-07135-00 |
| | | | R903V | Oil Pipe O-ring | \$1.19 | 93210-09008-00 |
| | | | R013B | Case Dowel O-ring | \$1.19 | 93210-10197-00 |
| | | | R014B | Oil Pipe O-ring | \$0.40 | 93210-12759-00 |
| | | | R027V | Timing Mark O-ring | \$1.19 | 93210-14369-00 |
| | | | R114B | Water Pipe O-ring | \$1.13 | 93210-16500-00 |
| | | | R19X2V | Fill Plug O-ring | \$2.50 | 93210-19123-00 |
| | | | R018V | Water Outlet O-rings | \$1.19 | 93210-19758-00 |
| | | | R12X2V | Output Shaft O-ring | \$1.19 | 93210-22298-00 |
| | | | R124B | Timing Gear O-ring | \$3.92 | 93210-32172-00 |
| | | | R134B | Oil Filter Cover O-ring | \$1.13 | 93210-47675-00 |
| Oil Seal Kit | | List Price | Component Part# | Component Description | List Price # | OEM Part # |
| C7947OS | | \$29.88 | OS236 | Oil Pump Seal | \$4.23 | 93101-14164-00 |
| | | | OS283 | Outer Water Pump Oil Seal | \$3.54 | 93109-11073-00 |
| | | | OS284 | Output Shaft Seal | \$5.09 | 93102-32480-00 |
| | | | OS285 | Kick Start Shaft Seal | \$1.48 | 93102-20108-00 |
| | | | OS286 | Hot Start Lever Oil Seal | \$4.29 | 93102-12224-00 |
| | | | OS286 | Clutch Pushrod Seal | \$4.29 | 93102-12224-00 |
| | | | OS286 | Shift Shaft Seal | \$4.29 | 93102-12224-00 |
| Clutch & Mag Kit | | List Price | Component Part# | Component Description | List Price | OEM Part # |
| C7947CM | | \$14.94 | EC761018AFM | Mag Cover Gasket | \$5.00 | 5TA-15451-00-00 |
| | | | C3129 | Outer Clutch Cover Gasket | \$9.94 | 5TA-15453-00-00 |
| | | | Component Part# | Component Description | List Price | OEM Part # |
| | | | VC104 | Valve Cover Gasket | \$23.80 | |



MX/Dirt • Off-Road • ATV Gaskets



Cometic Gasket - An Exclusive NASCAR Performance® Product

YAMAHA

| Model | Year | Bore Size | EST | List Price | Component Part# | Component Description | List Price | OEM Part # | |
|-----------------------------|-----------------------------------|-----------|---------------------------------|-------------------|------------------------|----------------------------------|-------------------------|-------------------|-----------------|
| YZ450F | 06-09 | 95 mm | Top End Kit C7908-EST | \$73.79 | H2477027S | Head Gasket 95mm | \$31.15 | 2S2-11181-00-00 | |
| | | 98 mm | C3178-EST | \$73.79 | H2477SP1027S | Head Gasket 98mm | \$31.15 | 2S2-11181-00-00 | |
| | | | | | H2477SP4027S | Head Gasket 99mm | \$31.15 | 2S2-11181-00-00 | |
| | | | | | B0849020RC | Base Gasket | \$11.87 | 2S2-11351-00-00 | |
| | | | | | EX696 | Exhaust Gasket | \$10.28 | 3VD-14613-01-00 | |
| | | | | | 3179V | Intake Valve Seal 3 Req. | \$5.50 ea. | 4SV-12119-00-00 | |
| | | | | | 3234V | Exhaust Valve Seal 2 Req. | \$5.50 ea. | 33M-12119-00-00 | |
| | | | | | EC019018AFM | Cam Chain Tensioner Gasket | \$2.04 | 4FM-12213-00 | |
| | | | | | WA082063C | Oil Line Washers 2 Req. | \$1.93 | 90430-10171 | |
| | | | | | WA114 | Drain Plug Gasket | \$3.02 | 90430-06014 | |
| | | | | | WA116 | Oil Line Washers 4 Req. | \$3.02 | 90201-08087-00 | |
| | Bottom End Kit w/Oil Seals | | | | | | | | |
| | | | | C7908BEF | \$75.99 | EC1100031F | Inner Clutch Cover | \$23.80 | 2S2-15462-10-00 |
| | | | | | | WP189 | Water Pump Cover Gasket | \$8.73 | 5BE-12439-00-00 |
| | | | | | WA080043C | Water Pump Drain Crush Washer | \$0.57 | 90430-06014-00 | |
| | | | | | WA080043C | Case Oil Galley Drain Plug | \$0.57 | 90430-06014-00 | |
| | | | | | WA116 | Case Water Galley Drain Plug | \$3.02 | 90430-08119-00 | |
| | | | | | WA082063C | Drain Plug Crush Seal | \$1.93 | 90430-10188-00 | |
| | | | | | R109B | Oil Pump O-rings | \$1.13 | 93210-07135-00 | |
| | | | | | R011V | Mag Cover Oil Passage O-ring | \$1.13 | 93210-08003-00 | |
| | | | | | R012B | Case Oil Level Plug O-ring | \$0.51 | 93210-09350-00 | |
| | | | | | R013B | Case Oil Galley O-ring | \$1.19 | 93210-10197-00 | |
| | | | | | R113B | Timing Mark O-ring | \$1.19 | 93210-14369-00 | |
| | | | | | R19X2V | Fill Plug O-Ring | \$2.50 | 93210-19123-00 | |
| | | | | | R018V | Primary Cover Oil Passage O-ring | \$1.19 | 93210-19758-00 | |
| | | | | | R12X2V | Output Shaft O-ring | \$1.19 | 93210-22298-00 | |
| | | | | | R121V | Crank End Plug O-ring | \$1.25 | 93210-27778-00 | |
| | | | | | R134B | Oil Pump Cover O-ring | \$1.13 | 93210-47675-00 | |
| | | | | | R143V | Electric Starter Cover O-ring | \$1.79 | 93210-58346-00 | |
| Oil Seal Kit | | | | List Price | Component Part# | Component Description | List Price # | OEM Part # | |
| | | | C7908OS | \$29.88 | OS227 | Inner Water Pump Oil Seal | \$2.67 | 93102-12321-00 | |
| | | | | | OS236 | Oil Pump Seal | \$4.23 | 93101-14164-00 | |
| | | | | | OS283 | Outer Water Pump Oil Seal | \$3.54 | 93109-11073-00 | |
| | | | | | OS284 | Output Shaft Seal | \$5.09 | 93102-32480-00 | |
| | | | | | OS285 | Kick Start Shaft Seal | \$1.48 | 93102-20108-00 | |
| | | | | | OS286 | Clutch Pushrod Seal | \$4.29 | 93102-12224-00 | |
| | | | | | OS286 | Shift Shaft Seal | \$4.29 | 93102-12224-00 | |
| Clutch & Mag Kit | | | | List Price | Component Part# | Component Description | List Price | OEM Part # | |
| | | | C7908CM | \$20.62 | EC763020F | Outer Clutch Cover | \$9.94 | 5TA-15453-00-00 | |
| | | | | | EC1099031F | Mag Cover Gasket | \$10.68 | 2S2-15451-00-00 | |
| | | | | | Component Part# | Component Description | List Price | OEM Part # | |
| | | | | | VC104 | Valve Cover Gasket | \$23.80 | | |



MX/Dirt • Off-Road • ATV Gaskets



Cometic Gasket - An Exclusive NASCAR Performance® Product

YAMAHA

| Model | Year | Bore Size | EST Top End Kit | List Price | Component Part# | Component Description | List Price | OEM Part # |
|------------------------|-------|--------------|--------------------|------------|-----------------------------------|-------------------------------|------------|-----------------|
| YZ450F | 10-13 | 97mm | C3395-EST | \$55.65 | H3059027S | 97mm Bore Head Gasket | \$31.15 | 33D-11181-00-00 |
| | | | | | 3238V | Valve Stem Seals 4 Required | \$1.36 ea. | 51Y-12119-00-00 |
| | | | | | B1019010RC | Base Gasket | \$13.62 | 33D-11351-00-00 |
| | | | | | EC019032AFM | Cam Chain Tensioner Gasket | \$2.04 | 4FM-12213-00-00 |
| | | | | | EX1041042AM | Exhaust Gasket | \$4.65 | 33D-14613-00-00 |
| | | | | | Bottom End Kit w/Oil Seals | | | |
| | | | C3395BE | \$75.99 | EC1569032AFM | Inner Clutch Gasket | \$23.80 | 33D-15462-00-00 |
| | | | | | R18X2.5V | Oil Fill Plug O-ring | \$1.71 | 93210-19123-00 |
| | | | | | R13.5X2V | Timing Mark O-ring | \$1.93 | 93210-14369-00 |
| | | | | | R126B | Crank Plug O-ring | \$1.13 | 93210-357A3-00 |
| | | | | | R010V | Oil Nozzle O-ring | \$0.40 | 93210-07001-00 |
| | | | | | MR111 | Case Seal Gasket | \$3.70 | 90430-08002-00 |
| | | | | | WA116 | Right Case Drain Washer | \$3.02 | 90201-08087-00 |
| | | | | | WA080043C | Left Case Drain Washer | \$0.57 | 90430-06014-00 |
| | | | | | R031B | Oil Filter Cover O-ring | \$4.65 | 93210-45708-00 |
| | | | | | R24X2V | Coolant Line Oring | \$6.19 | 93210-24253-00 |
| | | | | | R114B | Water Pump O-ring | \$1.13 | 93210-16500-00 |
| | | | | | R020V | Output Shaft O-ring | \$1.19 | 93210-22298-00 |
| | | | | | WP379018AFM | Water Pump Housing Gasket | \$5.19 | 33D-12427-00-00 |
| | | | | | WA114 | Water Pump Drain Plug Washer | \$3.02 | 90430-06014-00 |
| | | | | | R018V | Water Pipe O-ring | \$1.19 | 93210-19758-00 |
| Oil Seal Kit | | | | | | | | |
| | | | C3395OS | \$25.99 | OS285 | Start Shaft Seal 20x30x7 | \$1.48 | 93102-20108-00 |
| | | | | | OS284 | Output Shaft Seal 32x42x6 | \$8.83 | 93102-32480-00 |
| | | | | | OS286 | Shift Shaft Oil Seal 12x18x5 | \$4.29 | 93102-12224-00 |
| | | | | | OS227 | Water Pump Shaft Seal 12x22x5 | \$2.67 | 93102-12321-00 |
| | | | | | OS236 | Water Pump Oil Seal 14x22x5 | \$4.23 | 93101-14164-00 |
| EST Top End Kit | | | | | | | | |
| YZ450F | 14-16 | 97mm 99mm | C3540-EST | \$55.65 | H3059027S | 97mm Bore Head Gasket | \$31.15 | 33D-11181-00-00 |
| | | | | | 3238V | Valve Stem Seals 4 Required | \$1.36 ea. | 51Y-12119-00-00 |
| | | | | | B1241010RC | Base Gasket | \$13.62 | 1SL-11351-00-00 |
| | | | | | EC019032AFM | Cam Chain Tensioner Gasket | \$2.04 | 4FM-12213-00-00 |
| | | | | | EX1041042AM | Exhaust Gasket | \$4.65 | 33D-14613-00-00 |
| | | | C3547-EST | \$55.65 | | | | |



MX/Dirt · Off-Road · ATV Gaskets



Cometic Gasket - An Exclusive NASCAR Performance® Product

YFZ450

| Model | Year | Bore Size | EST | List Price | Component Part# | Component Description | List Price | OEM Part # |
|----------------------|-------|-----------|--|------------------------------|---------------------------------|--|------------------------------|-----------------------------|
| YFZ450 Carbureted | 04-13 | 96 mm | Top End Kit C3066-EST | \$89.38 | H2144027S | 96mm Head Gasket | \$40.93 | 5TA-11181-00-00 |
| | | 97 mm | C3445-EST | \$89.38 | H2144SP1027S | 97mm Head Gasket | \$40.93 | 5TA-11181-00-00 |
| | | 98 mm | C3068-EST | \$89.38 | H1683027S | 98mm Head Gasket | \$40.93 | 5TA-11181-00-00 |
| | | | | | B0626020RC | Base Gasket | \$11.81 | 5TA-11351-00-00 |
| | | | | | EX641 | Exhaust Gasket | \$10.96 | 3VD-14613-01-00 |
| | | | | | EC019018AFM | Cam Chain Tensioner Gasket | \$2.04 | 4FM-12213-00 |
| | | | | | 3179V | Intake Valve Seals 3 Req. | \$5.50 ea. | 4SV-12119-00-00 |
| | | | | | 3234V | Exhaust Valve Seals 2 Req. | \$5.50 ea. | 33M-12119-00-00 |
| | | | | | WA082063C | 2 Req. | \$1.93 | 90430-10171-00 |
| | | | | | WA114 | 2 Req. | \$3.02 | 90430-06014-00 |
| | | | | | WA116 | 4 Req. | \$3.02 | 90201-08087-00 |
| | | | | | R19X2V | Base dowel O-ring | \$2.50 | 93210-19758-00 |
| | | | Bottom End Kit w/o crank seals C3338 | List Price \$57.52 | Component Part# | Component Description | List Price | OEM Part # |
| | | | | | EC762032AFM | Inner Clutch Cover Gasket | \$8.69 | 5TA-15462-00-00 |
| | | | | | EC763032AFM | Outer Clutch Cover Gasket | \$9.94 | 5TA-15453-00-00 |
| | | | | | EC899032AFM | Mag Cover Gasket | \$5.91 | 5TG-15451-10-00 |
| | | | | | R10X2V | Center Case Dowel O-ring | \$1.59 | 93210-10197-00 |
| | | | | | R10X2V | Oil Pump Dowel O-ring | \$1.59 | 93210-10197-00 |
| | | | | | R10X2V | Oil Pump Tube O-ring | \$1.59 | 93210-10197-00 |
| | | | | | R12.5X2V | Oil Tube O-ring (Lg) | \$3.74 | 93210-12759-00 |
| | | | | | R13.5X2V | Timing Plug O-ring (Sm) | \$1.93 | 93210-14369-00 |
| | | | | | R19X2V | Inner Clutch O-rings | \$2.50 | 93210-19758-00 |
| | | | | | R22X2V | Counter Shaft O-ring | \$2.66 | 93210-22164-00/ 22298-00 |
| | | | | | R27X2V | Mag Cover Plug O-ring | \$1.86 | 93210-32172-00 |
| | | | | | R47X2.5V | Oil Filter Cover O-ring (Sm) | \$3.27 | 93210-47675-00 |
| | | | | | R60X3B | Water Pump Cover O-ring | \$3.21 | 93210-60426 |
| | | | | | R7X2V | 4 Req.-Oil Pump O-rings (Sm) | \$2.16 | 93210-07003-00/ 07540-00 |
| | | | | | R8.5X1.5V | Oil tube O-rings (Med) | \$1.13 | 93210-09008-00 |
| | | | | | WA082063C | Drain Plug Gasket | \$1.93 | 90430-10171 |
| | | | | | Component Part# VC104 | Component Description Valve Cover Gasket | List Price \$23.80 | OEM Part # |

YFZ450R

| Model | Year | Bore Size | EST | List Price | Component Part# | Component Description | List Price | OEM Part # |
|---------|-------|-----------|--|------------------------------|------------------------|-------------------------------|-------------------|-------------------|
| YFZ450R | 09-16 | 95mm | Top End Kit C7908-EST | \$73.79 | H2477027S | Head Gasket 95mm | \$31.15 | 2S2-11181-00-00 |
| | | 98mm | C3178-EST | \$73.79 | H2477SP1018S | Head Gasket 98mm | \$31.15 | 2S2-11181-00-00 |
| | | 99mm | C3279-EST | \$73.79 | H2477SP4018S | Head Gasket 99mm | \$31.15 | 2S2-11181-00-00 |
| | | | | | B0849014RC | Base Gasket | \$11.87 | 2S2-11351-00-00 |
| | | | | | EX696 | Exhaust Gasket | \$10.28 | 3VD-14613-01-00 |
| | | | | | EC019018AFM | Cam Chain Tensioner Gasket | \$2.04 | 4FM-12213-00 |
| | | | | | 3179V | Intake Valve Seals 3 Req. | \$5.50 ea. | 4SV-12119-00-00 |
| | | | | | 3234V | Exhaust Valve Seals 2 Req. | \$5.50 ea. | 33M-12119-00-00 |
| | | | Bottom End Kit w/o crank seals C3419 | List Price \$44.66 | Component Part# | Component Description | List Price | OEM Part # |
| | | | | | R013V | Crankcase O-ring | \$1.08 | 93210-10197-00 |
| | | | | | WA082063C | Drain Plug Gasket 2 Req. | \$1.93 | 90430-10148-00 |
| | | | | | WA114 | Case Bolt Seal | \$3.02 | 90430-06014-00 |
| | | | | | EC1559032AFM | Outer Clutch Cover | \$9.94 | 18P-15453-00-00 |
| | | | | | R134V | Oil Filter O-ring | \$3.92 | 93210-47675-00 |
| | | | | | R133B | Oil Filter Bolt O-ring 3 Req. | \$1.13 | 93210-47675-00 |
| | | | | | EC1558032AFM | Inner Clutch Cover | \$8.69 | 18P-15462-00-00 |
| | | | | | R117V | Dip Stick O-ring | \$1.19 | 93210-19026-00 |
| | | | | | EC1561032AFM | Mag Cover Gasket | \$10.68 | 18P-15451-00 |
| | | | | | EC1560018AFM | Pinion Cover Gasket | \$3.07 | 18P-15463-00 |
| | | | | | R127V | Crank Plug O-ring | \$3.92 | 93210-357A3-00 |
| | | | | | R114V | Timing Plug O-ring | \$1.19 | 93210-14369-00 |
| | | | | | R214B | Starter Input O-rings | \$0.51 | 93210-24235 |
| | | | | | R022B | Output Shaft O-ring | \$1.13 | 93210-25001-00 |
| | | | | | WP370018AFM | Water Pump Gasket | \$5.19 | 18P-12428-00-00 |



MX/Dirt · Off-Road · ATV Gaskets



Cometic Gasket - An Exclusive NASCAR Performance® Product

WR450

| Model | Year | Bore Size | EST | List Price | Component Part# | Component Description | List Price | OEM Part # |
|-------|-------|-----------|--------------------|------------|-----------------|----------------------------|------------|-----------------|
| WR450 | 03-06 | 95 mm | Top End Kit | | | | | |
| | | | C7947-EST | \$89.38 | H1710027S | Head Gasket | \$40.93 | 5TA-11181-00-00 |
| | | | C3147-EST | \$89.38 | H2144027S | Head Gasket 96mm Bore | \$40.93 | |
| | | | C3064-EST | \$89.38 | H1711027S | Head Gasket 97mm Bore | \$40.93 | |
| | | | C3148-EST | \$89.38 | H1683027S | Head Gasket 98mm Bore | \$40.93 | |
| | | | C3149-EST | \$89.38 | H1683SP2027S | Head Gasket 99mm Bore | \$40.93 | |
| | | | C3117-EST | \$89.38 | H1683SPB027S | Head Gasket 100mm Bore | \$40.93 | |
| | | | | | B0626020RC | Base Gasket | \$11.81 | 5TA-11351-00-00 |
| | | | | | B0626SP2020RC | Base Gasket 100mm Kits | \$11.81 | |
| | | | | | EX641 | Exhaust Gasket | \$10.96 | 3VD-14613-01-00 |
| | | | | | EC019018AFM | Cam Chain Tensioner Gasket | \$2.04 | 4FM-12213-00 |
| | | | | | EC019020F | Cam Chain Tensioner Gasket | \$2.04 | |
| | | | | | WA082063C | Oil Line Washers 2 Req. | \$1.93 | 90430-10171 |
| | | | | | 3179V | Intake Valve Seal 3 Req. | \$5.50 ea. | 4SV-12119-00-00 |
| | | | | | 3234V | Exhaust Valve Seal 2 Req. | \$5.50 ea. | 33M-12119-00-00 |

| Bottom End Kit w/Oil Seals | | List Price | Component Part# | Component Description | List Price # | OEM Part # |
|-----------------------------------|-------------------|------------------------|------------------------------|------------------------------|---------------------|-------------------|
| C3560BE | | \$75.99 | R018V | Water Outlet O-rings | \$1.19 | 93210-19758-00 |
| | | | WP189 | Water Pump Cover O-ring | \$8.73 | 5BE-12439-00-00 |
| | | | R12X2V | Output Shaft O-ring | \$1.19 | 93210-22298-00 |
| | | | R114B | Water Pipe O-ring | \$1.13 | 93210-16500-00 |
| | | | R013B | Oil Line O-rings | \$1.19 | 93210-10197-00 |
| | | | EC762032AFM | Inner Clutch Cover | \$8.69 | 5TA-15462-00-00 |
| | | | R19X2V | Fill Plug O-ring | \$2.50 | 93210-19123-00 |
| | | | R143K | Starter O-ring | \$1.79 | 93210-58346-00 |
| | | | R027V | Timing Mark O-ring | \$1.19 | 93210-14369-00 |
| | | | R013B | Case Dowel O-ring | \$1.19 | 93210-10197-00 |
| | | | WA082063C | Drain Plug Gasket | \$1.93 | 90430-10188-00 |
| | | | WA080043C | Coolant Drain Gasket | \$0.57 | 90430-06014-00 |
| Oil Seal Kit | List Price | Component Part# | Component Description | List Price # | OEM Part # | |
| C3560OS | | \$29.88 | OS236 | Oil Pump Seal | \$4.23 | 93101-14164-00 |
| | | | OS283 | Outer Water Pump Oil Seal | \$3.54 | 93109-11073-00 |
| | | | OS284 | Output Shaft Seal | \$5.09 | 93102-32480-00 |
| | | | OS285 | Kick Start Shaft Seal | \$1.48 | 93102-20108-00 |
| | | | OS286 | Shift Shaft Seal | \$4.29 | 93102-12224-00 |
| | | | OS286 | Clutch Pushrod Seal | \$4.29 | 93102-12224-00 |
| Clutch & Mag Kit | List Price | Component Part# | Component Description | List Price | OEM Part # | |
| C3560CM | | \$18.63 | EC763018AFM | Outer Clutch Cover Gasket | \$9.94 | 5TA-15453-00-00 |
| | | | EC2003032AFM | Mag Cover Gasket | \$10.68 | 5TJ-15451-00-00 |



MX/Dirt • Off-Road • ATV Gaskets



Cometic Gasket - An Exclusive NASCAR Performance® Product

WR450

| Model | Year | Bore Size | EST | List Price | Component Part# | Component Description | List Price | OEM Part # | | |
|-----------------------------|-------|-----------------------------------|--------------------|-------------|----------------------------------|-----------------------|--------------------|-----------------|-----------------|--|
| WR450 | 07-14 | 95 mm | Top End Kit | | | | | | | |
| | | | C7908-EST | \$73.79 | H2477027S | Head Gasket 95mm | \$31.15 | 2S2-11181-00-00 | | |
| | | 98 mm | C3178-EST | \$73.79 | H2477SP1027S | Head Gasket 98mm | \$31.15 | 2S2-11181-00-00 | | |
| | | | | | H2477SP4027S | Head Gasket 99mm | \$31.15 | 2S2-11181-00-00 | | |
| | | | | B0849020RC | Base Gasket | \$11.87 | 2S2-11351-00-00 | | | |
| | | | | EX696 | Exhaust Gasket | \$10.28 | 3VD-14613-01-00 | | | |
| | | | | 3179V | Intake Valve Seal 3 Req. | \$5.50 ea. | 4SV-12119-00-00 | | | |
| | | | | 3234V | Exhaust Valve Seal 2 Req. | \$5.50 ea. | 33M-12119-00-00 | | | |
| | | | | EC019018AFM | Cam Chain Tensioner Gasket | \$2.04 | 4FM-12213-00 | | | |
| | | | | WA082063C | Oil Line Washers 2 Req. | \$1.93 | 90430-10171 | | | |
| | | | | WA114 | Drain Plug Gasket | \$3.02 | 90430-06014 | | | |
| | | | | WA116 | Oil Line Washers 4 Req. | \$3.02 | 90201-08087-00 | | | |
| | | Bottom End Kit w/Oil Seals | | | | | | | | |
| | | | | C7908BE | 75.99 | EC1100031F | Inner Clutch Cover | 23.80 | 2S2-15462-10-00 | |
| | | | | WP189 | Water Pump Cover Gasket | | 5BE-12439-00-00 | | | |
| | | | | WA080043C | Water Pump Drain Crush Washer | 0.57 | 90430-06014-00 | | | |
| | | | | WA080043C | Case Oil Galley Drain Plug | 0.57 | 90430-06014-00 | | | |
| | | | | WA116 | Case Water Galley Drain Plug | 3.02 | 90430-08119-00 | | | |
| | | | | WA082063C | Drain Plug Crush Seal | 1.93 | 90430-10188-00 | | | |
| | | | | R109B | Oil Pump O-rings | 1.13 | 93210-07135-00 | | | |
| | | | | R011V | Mag Cover Oil Passage O-ring | 1.13 | 93210-08003-00 | | | |
| | | | | R012B | Case Oil Level Plug O-ring | 0.51 | 93210-09350-00 | | | |
| | | | | R013B | Case Oil Galley O-ring | 1.19 | 93210-10197-00 | | | |
| | | | | R113B | Timing Mark O-ring | 1.19 | 93210-14369-00 | | | |
| | | | | R19X2V | Fill Plug O-Ring | 2.50 | 93210-19123-00 | | | |
| | | | | R018V | Primary Cover Oil Passage O-ring | 1.19 | 93210-19758-00 | | | |
| | | | | R12X2V | Output Shaft O-ring | 1.19 | 93210-22298-00 | | | |
| | | | | R121V | Crank End Plug O-ring | 1.25 | 93210-27778-00 | | | |
| | | | | R134B | Oil Pump Cover O-ring | 1.13 | 93210-47675-00 | | | |
| | | | | | Electric Starter Cover O-ring | | 93210-58346-00 | | | |
| Oil Seal Kit | | | | | | | | | | |
| | | C7908OS | 29.88 | OS227 | Inner Water Pump Oil Seal | 2.67 | 93102-12321-00 | | | |
| | | | | OS236 | Oil Pump Seal | 4.23 | 93101-14164-00 | | | |
| | | | | OS283 | Outer Water Pump Oil Seal | 3.54 | 93109-11073-00 | | | |
| | | | | OS284 | Output Shaft Seal | 5.09 | 93102-32480-00 | | | |
| | | | | OS285 | Kick Start Shaft Seal | 1.48 | 93102-20108-00 | | | |
| | | | | OS286 | Clutch Pushrod Seal | 4.29 | 93102-12224-00 | | | |
| | | | | OS286 | Shift Shaft Seal | 4.29 | 93102-12224-00 | | | |
| Clutch & Mag Kit | | | | | | | | | | |
| | | C7908CM | \$20.62 | EC763020F | Outer Clutch Cover | 9.94 | 5TA-15453-00-00 | | | |
| | | | | EC1099031F | Mag Cover Gasket | 10.68 | 2S2-15451-00-00 | | | |
| | | | | VC104 | Valve Cover Gasket | \$23.80 | | | | |

YZ490

| Model | Year | Bore Size | Top End Kit | List Price | Component Part# | Component Description | List Price | OEM Part # |
|-------|-------|-----------|--------------------|------------|-----------------|-----------------------|------------|-----------------|
| YZ490 | 83 | 89 mm | C7138 | \$39.70 | H0166043C | Head Gasket | \$25.73 | 5X6-11181-00-00 |
| | | | | | B0063020F | Base Gasket | \$6.25 | 1LV-11351-00-00 |
| YZ490 | 84-86 | 89 mm | Top End Kit | | | | | |
| YZ490 | 87-90 | | C7090 | \$39.70 | H0062043C | Head Gasket | \$25.73 | 40T-11181-00-00 |
| WR500 | 91-93 | | | | B0063020F | Base Gasket | \$6.25 | 1LV-11351-00-00 |
| | | | | | IR018018AFM | Intake Gasket | \$3.80 | 2K7-13621-00-00 |

XTT500/SR500

| Model | Year | Bore Size | Top End Kit | List Price | Component Part# | Component Description | List Price | OEM Part # |
|------------------|-------|-----------|-------------|------------|-----------------|-----------------------|------------|-----------------|
| XTT500/ SR500 | 76-81 | 90 mm | C7252 | \$29.35 | H0193043F | Head Gasket | \$27.26 | 2J2-11181-09-00 |
| | | | | | B0188020F | Base Gasket | \$7.16 | 583-11351-00-00 |

XTT600XT/SRX

| Model | Year | Bore Size | Top End Kit | List Price | Component Part# | Component Description | List Price | OEM Part # |
|------------------|-------|-----------|-------------|------------|-----------------|-----------------------|------------|-----------------|
| TT600 XT, SRX | 83-87 | 98 mm | C7114 | \$29.35 | H0063043F | Head Gasket | \$22.32 | 1JK-11181-00 |
| | | | | | B0064020F | Base Gasket | \$7.16 | 1VJ-11351-00-00 |



MX/Dirt · Off-Road · ATV Gaskets



Cometic Gasket - An Exclusive NASCAR Performance® Product

XT600 / YFM600

| Model | Year | Bore Size | Top End Kit | List Price | Component Part# | Component Description | List Price | OEM Part # |
|---------|-------|-----------|-------------|------------|-----------------|----------------------------|------------|-----------------|
| YFM600 | 98-01 | 97 mm | C7213 | \$29.35 | H0267043F | Head Gasket 97mm | \$22.32 | 2KF-11181-01 |
| Grizzly | | 98 mm | C7276 | \$29.35 | H0320043F | Head Gasket 98mm | \$22.32 | 2KF-11181-01 |
| XT600 | 88-96 | 101 mm | C7277 | \$29.35 | H0321043F | Head Gasket 101mm | \$22.32 | 2KF-11181-01 |
| | | | | | B0064020F | Base Gasket | \$7.16 | 1VJ-11351-00-00 |
| | | | | | B1019010RC | Base Gasket | \$13.62 | 33D-11351-00-00 |
| | | | | | EC019032AFM | Cam Chain Tensioner Gasket | \$2.04 | 4FM-12213-00-00 |
| | | | | | EX1041042AM | Exhaust Gasket | \$4.65 | 33D-14613-00-00 |

YFM660R

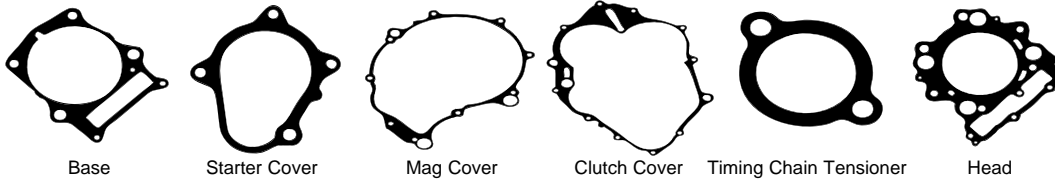

| Model | Year | Bore Size | EST Top End Kit | List Price | Component Part# | Component Description | List Price | OEM Part # |
|--------------------------|-------|-----------|---|-------------------------------|------------------------|-----------------------------------|-------------------|-------------------|
| YFM660R | 01-05 | 100mm | C7044-EST | \$89.44 | H1481SP2030S | Head Gasket 100mm Bore | \$27.26 | 3YF-11181-00 |
| Raptor | | 101mm | C7900-EST | \$89.44 | H1481030S | Head Gasket 101mm Bore | \$27.26 | |
| Rhino 660 (SXS) | 04-07 | 102mm | C7798-EST | \$89.44 | H1191030S | Head Gasket 102mm Bore | \$27.26 | |
| Fits Top End Only | | 103mm | C3042-EST | \$89.44 | H2174030S | Head Gasket 103mm Bore | \$27.26 | |
| | | 105mm | C7909-EST | \$89.44 | H1191SP1030S | Head Gasket 105mm Bore | \$27.26 | |
| | | | | | B0532010RC | Base Gasket | \$8.69 | 3YF-11351 |
| | | | | | EX361 | Exhaust Gasket 2 Req. | \$5.50 | 3YF-14613-01-00 |
| | | | | | EC584018AFM | Cam Chain Tensioner Gasket | \$3.58 | 4DW-12213-00 |
| | | | | | 3187V | Valve Seal 5 Req. | \$3.02 | 5H0-12119-00-00 |
| | | | | | R016B | Radiator Hose O-ring | \$0.74 | 93210-18417-00 |
| | | | | | R113B | Valve Cover Plug O-ring | \$1.19 | 93210-13657-00 |
| | | | | | R114S | Oil Tank O-ring | \$3.92 | 93210-16629-00 |
| | | | | | R116B | Cam Chain Tens. Cap O-ring | \$1.13 | 11101/93210 |
| | | | | | R117B | Dipstick O-ring | \$0.42 | 93210-21190-00 |
| | | | | | R124B | Tappet Cover O-ring | \$3.92 | 93210-32172-00 |
| | | | | | R155S | Cylinder Base O-ring | \$3.92 | 11256/93211 |
| | | | | | R71X2.5B | Intake Valve Adj. Cover O-ring | \$2.57 | 93210-71360-00 |
| | | | | | WA081080C | Oil Line Washers 4 Req. | \$0.06 | 90430-08204 |
| | | | | | WA082063C | Oil Line Washers 4 Req. | \$1.93 | 90430-10171 |
| | | | Bottom End Kit w/o crank seals C3339 | List Price \$40.12 | Component Part# | Component Description | List Price | OEM Part # |
| | | | | | EC580060AFM | Starter Cover Gasket | \$4.02 | 5LP-15455-00 |
| | | | | | EC581060AFM | Cover Gasket | \$11.18 | 5LP-15451-00 |
| | | | | | C7800 | Clutch Cover Gasket | \$19.14 | 5LP-15462-00 |
| | | | | | OP092010FB | Oil Pump Cover Gasket | \$1.25 | 5LP-13329-00 |
| | | | | | R027V | Crank Plug O-ring | \$0.74 | 93210-14369-00 |
| | | | | | R031B | Intake O-ring | \$4.65 | 93210-44545-00 |
| | | | | | R109B | Water Pump Impeller O-ring 2 Req. | \$1.13 | 11171/93210-77363 |
| | | | | | R125V | Water Outlet- Oring | \$1.19 | 93210-33786-00 |
| | | | | | R126B | Timing Plug O-ring | \$1.19 | 93210-357A3-00 |
| | | | | | R12X2V | Out Put Shaft O-ring | \$4.09 | 93210-22298-00 |
| | | | | | WA080043C | Drain Plug Washer | \$0.57 | 90430-06014-00 |



MX/Dirt • Off-Road • ATV Gaskets



Cometic Gasket - An Exclusive NASCAR Performance® Product

YFM700RV

| Model | Year | Bore Size | Top End Kit | List Price | Component Part# | Component Description | List Price | OEM Part # |
|---------|-------|-----------|---|-------------------|-----------------|------------------------------|------------|-------------------|
| YFM700 | 06-16 | 103mm | C3142-EST | \$89.44 | H2449027S | Head Gasket 103mm | \$40.55 | 1S3-11181-00-00 |
| YFM700F | 07-15 | 104mm | C3143-EST | \$89.44 | H2449SP2027S | Head Gasket 104mm | \$40.55 | |
| Grizzly | | 105.5mm | C3144-EST | \$89.44 | H2465027S | Head Gasket 105.5mm | \$40.55 | |
| | | | | | B0855010RC | Base Gasket | \$9.47 | 1S3-11351-00-00 |
| | | | | | EX361 | Exhaust Gasket 2 Req. | \$5.50 | 3YF-14613-01-00 |
| | | | | | R034V | Throttle Body O-ring | \$3.00 | 4WV-14147-10-00 |
| | | | | | R0126V | Water Pump O-ring | \$1.19 | 93210-33786-00 |
| | | | | | R131B | Thermostat O-ring | \$1.13 | 93210-41042-00 |
| | | | | | R240V | Cam Cover O-ring | \$3.92 | 93210-96601-00 |
| | | | | | R79X2.5V | Valve Cover O-rings 2 Req. | \$7.29 | 93210-78544-00 |
| | | | | | 3187V | Valve Seal 4 Req. | \$3.02 | 5H0-12119-00-00 |
| | | | | | EC584018AFM | Cam Chain Tensioner Gasket | \$3.58 | 4DW-12213-00 |
| | | | Bottom End Kit w/o crank seals | List Price | | Component Description | | OEM Part # |
| | | | C3581 | \$88.39 | | Inner Crankcase Cover Gasket | | 3B4-15451-00-00 |
| | | | | | | Outer Crankcase Cover Gasket | | 3B4-15453-00-00 |
| | | | | | | O-ring | | 93210-14369-00 |
| | | | | | | Crankcase Seal | | 3B4-15379-00-00 |
| | | | | | | Oil Seal | | 93101-12168-00 |
| | | | | | | Oil Pump Cover Gasket | | 3B4-13329-00-00 |
| | | | | | | Oil Drain Bolt Washer | | 214-11198-01-00 |
| | | | | | | Oil Cooler Gasket | | 1XD-13475-00-00 |
| | | | | | | Oil Line Washers 4 Req. | | 90430-14043-00 |
| | | | | | | Oil Line Washers 4 Req. | | 90430-08119-00 |
| | | | | | | Oil Line Washers 2 Req. | | 90430-10188-00 |
| | | | | | | Oil Relief O-ring | | 93210-10096-00 |

YFM700

| Model | Year | Bore Size | Top End Kit | List Price | Component Part# | Component Description | List Price | OEM Part # |
|---------|------|-----------|-------------|------------|-----------------|-----------------------------|------------|-----------------|
| YFM700 | 2016 | 103mm | C3599-EST | \$64.58 | EC2098032AFM | Cam Chain Tensioner Gasket | \$2.46 | 2MB-E2213-00-00 |
| Grizzly | | | | | MA0164 | Cam Chain Tensionor | \$0.93 | 2MB-YFM700 |
| YFM700 | | | | | | Crush Gasket | | E21E2-00-00 |
| Kodiak | | | | | B1306010RC | Cylinder Base Gasket | \$9.47 | 2MB-E1351-00-00 |
| | | | | | H4173023S | 103mm Bore Cyl. Head Gasket | \$40.55 | 2MB-E1181-00-00 |
| | | | | | VC362018AFM | Valve Cover Breather Gasket | \$4.02 | 2MB-E131B-00-00 |
| | | | | | EX045 | Header Gasket | \$4.26 | 3EG-14613-00-00 |
| | | | | | WA117 | Oil Line Banjo Bolt | \$0.95 | 2MB-E1195-00-00 |
| | | | | | | Crush Gaskets | | |
| | | | | | 3250V | Exhaust Valve Seal | \$1.48 | 2MB-E2129-00-00 |
| | | | | | 3250V | Intake Valve Seal | \$1.48 | 2MB-E2119-00-00 |
| | | | | | R125V | Water Outlet O-ring | \$1.19 | 2MB-E2843-00-00 |



STREET·ROAD RACE·STRIP



Cometic Gasket - An Exclusive NASCAR Performance® Product

APRILIA

| Model | Year | Type | Bore Size | Displacement / cc | Material | Part # | Price | OEM Part # |
|----------------|-------|--------------|-----------|-------------------|-----------------|-----------|----------|------------|
| RSV1000R Mille | 98-06 | Head Gaskets | 98mm | 997cc-1018cc | MLS/C.O.T. .018 | C8511-018 | \$110.84 | |
| | | | 100mm | 1018cc-1060cc | MLS/C.O.T. .018 | C8512-018 | \$110.84 | |

DUCATI

| Model | Year | Type | Bore Size | Displacement / cc | Material | Part # | Price | OEM Part # |
|---------------------|-------|-------------|-----------|-------------------|-------------------|--------|----------|--------------|
| 748 | 94-02 | Head Gasket | 88mm | 748cc | MLS/C.O.T. .030 | C8753 | \$71.55 | 786.1053.2A |
| | | | | | Spring Steel .020 | C8754 | \$39.75 | 786.1.068.1A |
| 851 | 87-81 | Head Gasket | 91mm | 858cc | SLS/C.O.T. .017 | C8560 | \$66.33 | |
| | | Head Gasket | 96mm | 888-955cc | SLS/C.O.T. .017 | C8564 | \$66.33 | |
| 888 | 91-98 | Head Gasket | 96mm | 888-955cc | Spring Steel .020 | C8755 | \$31.80 | |
| | | Base Gasket | | | SLS/C.O.T. .017 | C8564 | \$66.33 | |
| 916 | 91-98 | Head Gasket | 96mm | 888-955cc | Spring Steel .020 | C8755 | \$31.80 | |
| | | Base Gasket | | | SLS/C.O.T. .017 | C8564 | \$66.33 | |
| 996 | 99-02 | Head Gasket | 98mm | 995cc | Spring Steel .020 | C8755 | \$31.80 | |
| | | Base Gasket | | | SLS/C.O.T. .017 | C8561 | \$66.33 | 786.1.048.1A |
| 996R | 2001 | Head Gasket | 100mm | | Spring Steel .014 | C8756 | \$23.29 | |
| | | Head Gasket | 102mm | | MLS/C.O.T. .027 | C8757 | \$173.54 | 786.1.055.1B |
| 1000 DS Super Sport | 89-07 | Head Gasket | 98mm | 1025cc | MLS/C.O.T. .027 | C8758 | \$173.54 | |
| | | Base Gasket | | | SLS/C.O.T. .010 | C8700 | \$47.64 | 786.1.064.1A |
| 1098, 1098S | 07-08 | Head Gasket | 104mm | | Spring Steel .014 | C8759 | \$18.96 | 786.1.063.1A |
| | | Base Gasket | | | MLS/C.O.T. .027 | C8807 | \$83.43 | 786.1.092.2A |
| 1198, 1198S, 1198R | 09-11 | Head Gasket | 106mm | | Spring Steel .014 | C8809 | \$26.37 | 786.1.094.1A |
| | | Base Gasket | | | MLS/C.O.T. .027 | C8808 | \$83.43 | 786.1.100.1A |
| Panigale 1199 | 12-14 | Head Gasket | 113mm | | Spring Steel .014 | C8809 | \$26.37 | 786.1.094.1A |
| | | Head Gasket | 116mm | | MLS/C.O.T. .020 | C8834 | \$83.43 | 786.1.121.2C |
| | | | | | MLS/C.O.T. .020 | C8835 | \$83.43 | |

HONDA

| Model | Year | Type | Bore Size | Displacement / cc | Material | Part # | Price | OEM Part # | |
|-------------------|-------|-------------|-----------|-------------------|-----------------|-------------|----------|---------------|---------------|
| CBR250 | 11-13 | Top End Kit | 77mm | | MLS/C.O.T. .027 | C3522-EST | \$58.95 | | |
| CBR250 | 11-13 | Top End Kit | 78mm | | MLS/C.O.T. .027 | C3523-EST | \$58.95 | | |
| CBR250 | 11-13 | Top End Kit | 80mm | | MLS/C.O.T. .027 | C3524-EST | \$58.95 | | |
| CBR250 | 11-13 | Top End Kit | 81mm | | MLS/C.O.T. .027 | C8832-EST | \$58.95 | | |
| CBR250 | 11-13 | Top End Kit | 83mm | | MLS/C.O.T. .027 | C3526-EST | \$58.95 | | |
| CB500 | 13-15 | Head Gasket | 69mm | | MLS/C.O.T. .023 | C8887 | \$37.68 | 45584-MGZ-J01 | |
| | 13-15 | Head Gasket | 70mm | | MLS/C.O.T. .023 | C8888 | \$37.68 | | |
| CB500 | 72-74 | Head Gasket | 59mm | | MLS/C.O.T. .040 | C8824 | \$87.73 | 12251-374-306 | |
| CB550 | 74-78 | Head Gasket | 60mm | | MLS/C.O.T. .040 | C8825 | \$87.73 | 12251-374-306 | |
| CB650 | 79-82 | Head Gasket | 61mm | | MLS/C.O.T. .040 | C8826 | \$87.73 | 12251-374-306 | |
| | | Head Gasket | 62mm | | MLS/C.O.T. .040 | C8827 | \$87.73 | 12251-426-306 | |
| CBR600F Hurricane | 87-90 | Head Gasket | 65 mm | 600cc-637cc | Copper .020 | C8000 | \$65.64 | 12251-MN4-003 | |
| | | Base Gasket | | | 635cc | Copper .010 | C8503 | \$35.38 | 12191-MN4-004 |
| | | Base Gasket | | | 635cc | Copper .020 | C8504 | \$35.38 | 12191-MN4-004 |
| CBR600 | 91-98 | Head Gasket | 67.0 mm | 618cc thru 637cc | MLS/C.O.T. .030 | C8265 | \$87.73 | 12251-MAL-601 | |
| | | | | | MLS/C.O.T. .018 | C8265-018 | \$100.22 | 12251-MAL-601 | |
| CBR600 F2 | 91-94 | Head Gasket | 67 mm | 618cc thru 637cc | MLS/C.O.T. .030 | C8265 | \$87.73 | 12251-MAL-601 | |
| | | | | | MLS/C.O.T. .018 | C8265-018 | \$100.22 | 12251-MAL-601 | |
| CBR600 F3 | 95-98 | Head Gasket | 67 mm | 618cc thru 637cc | MLS/C.O.T. .030 | C8265 | \$87.73 | 12251-MAL-601 | |
| | | | | | MLS/C.O.T. .018 | C8265-018 | \$100.22 | 12251-MAL-601 | |
| CBR600 F4 | 99-06 | Head Gasket | 67 mm | | MLS/C.O.T. .030 | C8572 | \$87.73 | 12251-MBW-013 | |
| | | | 67 mm | | MLS/C.O.T. .018 | C8572-018 | \$100.22 | 12251-MBW-013 | |
| | | | 68 mm | | MLS/C.O.T. .030 | C8636 | \$87.73 | 12251-MBW-013 | |
| | | | 69 mm | | MLS/C.O.T. .030 | C8671 | \$87.73 | 12251-MBW-013 | |
| CBR600 RR | 03-06 | Head Gasket | 67 mm | 599cc | MLS/C.O.T. .027 | C8704-027 | \$87.73 | 12251-MBW-013 | |
| | | | | | MLS/C.O.T. .018 | C8704-018 | \$100.22 | 12251-MBW-013 | |
| | | | | 599-635cc | MLS/C.O.T. .027 | C8706-027 | \$87.73 | 12251-MBW-013 | |
| | | | | | MLS/C.O.T. .018 | C8706-018 | \$100.22 | 12251-MBW-013 | |
| | | | | 636-654cc | MLS/C.O.T. .027 | C8705-027 | \$87.73 | 12251-MBW-013 | |
| CBR600 RR | 07-15 | Head Gasket | 68.5mm | 599cc-626cc | MLS/C.O.T. .018 | C8705-018 | \$100.22 | 12251-MBW-013 | |
| | | | | | MLS/C.O.T. .027 | C8736 | \$83.52 | 12251-MFJ-D01 | |
| | | | | 627cc-654cc | MLS/C.O.T. .018 | C8736-018 | \$94.88 | 12251-MFJ-D01 | |
| | | | | | MLS/C.O.T. .027 | C8737 | \$83.52 | 12251-MFJ-D01 | |
| | | | | | MLS/C.O.T. .018 | C8737-018 | \$94.88 | 12251-MFJ-D01 | |
| NT650 Hawk GT | 88-91 | Head Gasket | 82mm | 700cc | Stainless .010 | C8207 | \$53.34 | 12251-MN8-911 | |
| | | Base Gasket | | | Copper .010 | C8520 | \$30.72 | 12191-MN8-003 | |
| VFR750 | 90-94 | Head Gasket | 72.0 mm | 750cc | CFM-20 | C8498 | \$54.35 | 12251-MR7-003 | |
| CB750 2 Valve | 71-78 | Head Gasket | 65 mm | 811cc-836cc | CFM-20 | C8001 | \$54.35 | 12251-300-307 | |
| | | | 67.5 mm | 837cc-915cc | CFM-20 | C8002 | \$54.35 | 12251-300-307 | |
| | | Base Gasket | 70.5 mm | | Copper .005 | C8286 | \$35.38 | 12191-300-020 | |
| | | | 70.5 mm | | Copper .010 | C8287 | \$35.38 | 12191-300-020 | |
| | | | 70.5 mm | | Copper .020 | C8288 | \$35.38 | 12191-300-020 | |
| | | | 70.5 mm | | Fiber .020 | C8289 | \$13.97 | 12191-300-020 | |
| CB750K 2V | 73-78 | Head Gasket | 65mm | | MLS/C.O.T. .045 | C8801 | \$63.94 | | |
| | | Head Gasket | 68mm | | MLS/C.O.T. .045 | C8802 | \$63.94 | | |
| | | Head Gasket | 70mm | | MLS/C.O.T. .045 | C8803 | \$63.94 | | |
| | | Head Gasket | 72mm | | MLS/C.O.T. .045 | C8804 | \$63.94 | | |

All Component Parts can be purchased individually.



STREET·ROAD RACE·STRIP



Cometic Gasket - An Exclusive NASCAR Performance® Product

HONDA

| Model | Year | Type | Bore Size | Displacement / cc | Material | Part # | Price | OEM Part # |
|---------------------|-------------|-------------|-----------|-------------------|-------------------|-----------|-----------------------|-----------------------------|
| CB750SC 4 Valve | 79-83 | Head Gasket | 65 mm | 823cc | CFM-20 | C8003 | \$54.35 | 12251-425-000 |
| | 79-83 | | 70 mm | 890-955cc | CFM-20 | C8004 | \$54.35 | 12251-425-000 |
| | 79-83 | Base Gasket | 74 mm | | Copper .005 | C8451 | \$35.38 | 12191-425-000/010/306 |
| | | | | | Copper .010 | C8452 | \$33.68 | 12191-425-000/010/306 |
| | | | | | Copper .020 | C8453 | \$33.68 | 12191-425-000/010/306 |
| | | | | Fiber .020 | C8454 | \$13.29 | 12191-425-000/010/306 | |
| CB900C 900 Custom | 80-82 | Head Gasket | 68 mm | 985cc | CFM-20 .043 | C8005 | \$54.35 | |
| | 79-83 | Base Gasket | 74 mm | | Copper .005 | C8451 | \$35.38 | |
| | | | | | Copper .010 | C8452 | \$33.68 | |
| | | | | | Copper .020 | C8453 | \$33.68 | |
| | | | | | Fiber .020 | C8454 | \$13.29 | |
| CB900F Super Sport | 81-82 | Head Gasket | 68 mm | 985cc | CFM-20 | C8005 | \$54.35 | |
| | | | 72 mm | 1123cc | Copper .043 | C8224 | \$65.64 | |
| CBR900 919 (CB900F) | 93-99 02-07 | Head Gasket | 72 mm | 945cc | MLS/C.O.T. .040 | C8267 | \$83.52 | 12251-MW0/MAS-003 |
| | | | 72 mm | | MLS/C.O.T. .018 | C8267-018 | \$95.45 | 12251-MW0/MAS-003 |
| | | | 73 mm | 970cc | MLS/C.O.T. .040 | C8401 | \$83.53 | 12251-MW0/MAS-003 |
| | | | 73 mm | | MLS/C.O.T. .018 | C8401-018 | \$95.45 | 12251-MW0/MAS-003 |
| | | | 74 mm | 997cc | MLS/C.O.T. .040 | C8268 | \$87.73 | 12251-MW0/MAS-003 |
| | | | 74 mm | | MLS/C.O.T. .018 | C8268-018 | \$95.45 | 12251-MW0/MAS-003 |
| | | | 75 mm | 1033cc | MLS/C.O.T. .040 | C8406 | \$83.52 | 12251-MW0/MAS-003 |
| CBR929 | 00-01 | Head Gasket | 76mm | 980cc | MLS/C.O.T. .030 | C8568 | \$87.73 | 12251-MCJ-003/013 |
| | | | 76mm | 980cc | MLS/C.O.T. .018 | C8568-018 | \$100.22 | 12251-MCJ-003/013 |
| CBR954 | 02-03 | Head Gasket | 76mm | 980cc | MLS/C.O.T. .030 | C8568 | \$87.73 | 12251-MCJ-003/013 |
| | | | 76mm | 980cc | MLS/C.O.T. .018 | C8568-018 | \$100.22 | 12251-MCJ-003/013 |
| CBR1000 | thru 95 | Head Gasket | 79.0 mm | 1050cc | Stainless .010 | C8008 | \$87.73 | 12251-MW7-791 |
| | | Base Gasket | 84.5 mm | | Copper .005 | C8410 | \$35.38 | 12191-MS2 611 |
| CBR1000 RR | 04-07 | Head Gasket | 75.0 mm | 998cc | MLS/C.O.T. .027 | C8702-027 | \$87.73 | 12251-MEL-013 |
| | | | | | MLS/C.O.T. .018 | C8702-018 | \$100.22 | 12251-MEL-013 |
| | | | 76.0 mm | 1025cc | MLS/C.O.T. .027 | C8703-027 | \$87.73 | 12251-MEL-013 |
| | | | | | MLS/C.O.T. .018 | C8703-018 | \$100.22 | 12251-MEL-013 |
| | | | 77 mm | 1052cc | MLS/C.O.T. .027 | C8727 | \$87.73 | 12251-MEL-013 |
| | | | | MLS/C.O.T. .018 | C8727-018 | \$100.22 | 12251-MEL-013 | |
| CBR1000RR | 08-14 | Head Gasket | 77mm | 1000-1026cc | MLS/C.O.T. .027 | C8779 | \$87.73 | 12251-MFL-003 |
| | | | | | MLS/C.O.T. .018 | C8779-018 | \$100.22 | 12251-MFL-003 |
| RVT1000R/RC51 | 00-06 | Base Gasket | | | Spring Steel .010 | C8780 | \$29.24 | 12191-MFL-003 |
| | | Head Gasket | 101.5mm | 999cc | MLS/C.O.T. .027 | C8569 | \$83.52 | 12251-MCF-003/12252-MCF-003 |
| | | | 102.5mm | 1030cc | MLS/C.O.T. .027 | C8765 | \$83.52 | 12251-MCF-003/12252-MCF-003 |
| | | | 103.5mm | 1051cc | MLS/C.O.T. .027 | C8766 | \$83.52 | 12251-MCF-003/12252-MCF-003 |
| CBX 6 Cylinder | 79-82 | Head Gasket | 65 mm | 1047cc | CFM-20 | C8407 | \$83.65 | 12251-422-306 |
| | | | 65 mm | 1047cc | Copper .043 | C8396 | \$96.19 | 12251-422-306 |
| | | | 67.5 mm | 1147cc | Copper .043 | C8319 | \$96.19 | 12251-422-306 |
| | | | 68 mm | 1147cc | CFM-20 | C8341 | \$83.65 | 12251-422-306 |
| | | | 73 mm | | Fiber .020 | C8342 | \$26.51 | 12191-422-306 |
| CB1100F | 83 | Head Gasket | 72 mm | 1123cc | CFM-20 | C8006 | \$53.34 | 12251-MG5-670 |
| | | | 72 mm | 1123 cc | Copper .043 | C8224 | \$65.64 | 12251-MG5-670 |
| | | | 74 mm | 1186 cc | Copper .043 | C8225 | \$62.51 | 12251-MG5-670 |
| CBR1100XX Blackbird | 97-03 | Head Gasket | 75 mm | 1219cc | Copper .020 | C8007 | \$59.46 | 12251-MG5-670 |
| | | Base Gasket | 79.5 mm | | Copper .020 | C8521 | \$35.38 | 12191-MG5-306 |
| CBR1100XX Blackbird | 97-03 | Head Gasket | 81.0 mm | 1195cc | MLS/C.O.T. .030 | C8499 | \$87.73 | 12251-MAT-003 |
| | | | | | MLS/C.O.T. .018 | C8499-018 | \$95.45 | 12251-MAT-003 |
| CB900C 900 Custom | 80-82 | Head Gasket | 68 mm | 985cc | CFM-20 .043 | C8005 | \$54.35 | |
| | 79-83 | Base Gasket | 74 mm | | Copper .005 | C8451 | \$35.38 | |
| | | | | | Copper .010 | C8452 | \$33.68 | |
| | | | | | Copper .020 | C8453 | \$33.68 | |
| | | | | | Fiber .020 | C8454 | \$13.29 | |
| CB900F Super Sport | 81-82 | Head Gasket | 68 mm | 985cc | CFM-20 | C8005 | \$54.35 | |
| | | | 72 mm | 1123cc | Copper .043 | C8224 | \$65.64 | |



Honda Engine Case Rebuild

| Model | Year | Part Description | Part # | Retail | OEM Part # | | |
|---------------------|-----------|----------------------------|-----------------|---------------------|---------------|---------|---------------|
| CBR600 F4 | 99-06 | Engine Case Rebuild | C8633 | \$41.79 | | | |
| | | Cam Chain | EC388018AFM | \$3.97 | 14523-MAL-A00 | | |
| | | Ignition | EC625018AFM | \$13.97 | | | |
| | | Oil Pan | EC626018AFM | \$16.69 | | | |
| | | Generator | EC627018AFM | \$9.14 | | | |
| CBR600 F2,F3 | 91-98 | Engine Case Rebuild | C8301 | \$28.67 | | | |
| | | Oil Pan | EC032020F | \$16.23 | 11394-MV9-670 | | |
| | | Clutch Cover | EC033020F | \$6.71 | 11393-MV9-670 | | |
| | | Generator | EC034020F | \$8.29 | 11392-MV9-670 | | |
| | | Pulse Ignition | EC035020F | \$3.35 | 11391-MV9-670 | | |
| CBR600RR | 07-14 | Engine Case Rebuild | C8739 | \$41.79 | | | |
| | | Alternator Cover | EC1231032AFM | \$15.85 | | | |
| | | Clutch Cover | EC1232032AFM | \$21.53 | | | |
| | | Cam Chain | EC814018AFM | \$3.74 | 14523-MAL-A00 | | |
| | | Oil Pan | OP217032AFM | \$19.25 | | | |
| CB750K 2V | 73-78 | Engine Case Rebuild Kit | C8863 | \$45.99 | | | |
| | | Mag Cover Gasket | EC1024032AFM | \$11.93 | 11397-300-306 | | |
| | | Cam Chain Tensioner Gasket | EC1023060AFM | \$3.35 | 14592-300-306 | | |
| | | Clutch Cover Gasket | EC1435SP1060AFM | \$20.28 | 11396-300-306 | | |
| | | Valve Cover Gasket | VC122060AFM | \$19.87 | 12391-300-306 | | |
| | | Oil Pan Gasket | OP355032AFM | \$4.49 | 11398-300-306 | | |
| | | Oil Pump Gasket | EC1699060AFM | \$18.38 | 15135-300-010 | | |
| | | Points Cover Gasket | EC1968032AFM | \$5.34 | 30372-300-300 | | |
| | | Starter Motor Cover Gasket | EC1969032AFM | \$4.02 | 31282-300-020 | | |
| | | Trans Cover Gasket | EC1964032AFM | \$7.92 | 11395-300-306 | | |
| | | _CBR900 919 (CBR900F) | 93-99 02-07 | Engine Case Rebuild | C8211 | \$39.80 | |
| | | | | Oil Pan | EC032020F | \$16.23 | 11394-MV9-670 |
| Clutch Cover | EC033020F | | | \$6.71 | 11393-MV9-670 | | |
| Dyno | EC034020F | | | \$8.29 | 11392-MV9-670 | | |
| Ignition | EC035020F | | | \$3.35 | 11391-MV9-670 | | |
| Cam Chain | EC036020F | | | \$2.04 | 121940HC5-740 | | |
| CA Emission | EC037043F | | | \$2.84 | 18647-MWO-750 | | |
| CBR929 / 954 | 00-03 | | | Engine Case Rebuild | C8634 | \$41.79 | |
| | | | | Generator | EC628018AFM | \$9.14 | 11392-MCJ-000 |
| | | Oil Pan | EC629018AFM | \$15.99 | | | |
| | | Ignition / Clutch | EC630018AFM | \$16.69 | | | |
| | | Cam Chain | EC631018AFM | \$3.97 | 14523-MCJ-000 | | |
| CBR1100XX Blackbird | 97-03 | Engine Case Rebuild | C8586 | \$45.99 | | | |
| | | Cam Chain | EC388020F | \$3.97 | 14523-MAL-A00 | | |
| | | Cam Pulser | EC389020F | \$3.97 | 22862-MW7-650 | | |
| | | Pulser Cover | EC390020F | \$12.54 | 11392-MAT-000 | | |
| | | Alternator Cover | EC391020F | \$11.13 | 11393-MAT-000 | | |
| | | Clutch Cover | EC392020F | \$16.69 | | | |

KAWASAKI

| Model | Year | Type | Bore Size | Displacement / cc | Material | Part # | Price | OEM Part # | |
|-----------------------|-------|-------------|-----------|-------------------|-------------------|-----------------|------------|-----------------------|-----------------------|
| CB750SC 4 Valve | 79-83 | Head Gasket | 65 mm | 823cc | CFM-20 | C8003 | \$54.35 | 12251-425-000 | |
| | | | 70 mm | 890-955cc | CFM-20 | C8004 | \$54.35 | 12251-425-000 | |
| | 79-83 | Base Gasket | 74 mm | | Copper .005 | C8451 | \$35.38 | 12191-425-000/010/306 | |
| | | | | | | Copper .010 | C8452 | \$33.68 | 12191-425-000/010/306 |
| | | | | | | Copper .020 | C8453 | \$33.68 | 12191-425-000/010/306 |
| EX250 Ninja | 86-07 | Head Gasket | 62mm | | Spring Steel .012 | C8828 | \$31.47 | 11004-1312 | |
| | | | 64mm | | Spring Steel .012 | C8829 | \$31.47 | 11004-1312 | |
| | 08-12 | Head Gasket | 62mm | SLS .012" | C8859 | \$31.47 | 11004-0080 | | |
| | | | 64mm | SLS .012" | C8860 | \$31.47 | 11004-0080 | | |
| | | | 66mm | SLS .012" | C8861 | \$31.47 | 11004-0080 | | |
| EX500 Ninja 500, 500R | 87-09 | Head Gasket | 75.5mm | 500cc | CFM-20 .043 | C8318 | \$51.68 | 11004-1159 | |
| KZ 550 Ltd. | 80-83 | Head Gasket | 61mm | 550cc-615cc | CFM-20 .043 | C8009 | \$54.35 | 11004-1212/1021 | |
| GP, GPz 550 | 81-85 | | | | | | | 11004-1212/1021 | |
| Zeyphr 550 | 90-91 | | | | | | | 11004-1212/1021 | |
| ZX600, B1,C1-7 | 87-94 | Head Gasket | 62mm | 612cc-633cc | .043 CFM-20 | C8010 | \$51.73 | 11004-1206 | |
| Ninja 600R | | Base Gasket | 2.680 | 600cc-635cc | .005 Copper | C8589 | \$33.68 | 11009-1855 | |
| ZX600 Ninja 600R | 95-02 | Head Gasket | 68 mm | 617cc-636cc | MLS/C.O.T. .030 | C8270 | \$83.52 | 11004-1303/1348 | |
| Ninja ZX-6R | 95-99 | Head Gasket | 68 mm | 617cc-636cc | MLS/C.O.T. .018 | C8270-018 | \$95.45 | 11004-1303/1348 | |
| ZZR600 | 05-08 | | 70 mm | 636cc-674cc | MLS/C.O.T. .027 | C8694 | \$83.52 | 11004-1348 | |
| | | | 70 mm | 636cc-674cc | MLS/C.O.T. .018 | C8694-018 | \$95.45 | 11004-1348 | |
| Ninja ZX-6R | 00-02 | Head Gasket | 68mm | | .010 Copper | C8354 | \$33.68 | 11060-1844 | |
| | | | | | Spring Steel .010 | C8698 | \$30.72 | 11060-1844 | |
| | | | | | MLS/C.O.T. .027 | C8693 | \$83.52 | 11004-1348 | |
| | | | | | MLS/C.O.T. .018 | C8693-018 | \$95.45 | 11004-1348 | |
| | | Base Gasket | | 70mm | | MLS/C.O.T. .027 | C8694 | \$83.52 | 11004-1348 |
| | | | | MLS/C.O.T. .018 | C8694-018 | \$95.45 | 11004-1348 | | |
| | | | | Spring Steel .010 | C8698 | \$33.68 | 11060-1844 | | |

All Component Parts can be purchased individually.



STREET·ROAD RACE·STRIP



Cometic Gasket - An Exclusive NASCAR Performance® Product

KAWASAKI

| Model | Year | Type | Bore Size | Displacement / cc | Material | Part # | Price | OEM Part # | |
|---------------------------------|-------|-------------|-----------|-------------------|--------------------|-------------|----------|---|------------|
| Ninja ZX-6R | 03-06 | Head Gasket | 68mm | 636cc | MLS/C.O.T. .027 | C8690 | \$83.52 | 11004-1383 | |
| | | | 69mm | 636cc-655cc | MLS/C.O.T. .018 | C8690-018 | \$94.45 | 11004-1383 | |
| | | | 70mm | 656cc-674cc | M.L.S./C.O.T. .027 | C8701 | \$83.52 | 11004-1383 | |
| | | | | | MLS/C.O.T. .018 | C8701-018 | \$100.22 | 11004-1383 | |
| | | | | | M.L.S./C.O.T. .027 | C8696 | \$83.52 | 11004-1383 | |
| Ninja ZX-6R | 07-12 | Head Gasket | 68mm | 636cc | MLS/C.O.T. .027 | C8751 | \$87.73 | 11004-0078 | |
| | | | | 636cc | MLS/C.O.T. .018 | C8751-018 | \$100.22 | 11004-0078 | |
| | | | | | Spring Steel .010 | C8692 | \$33.68 | 11061-0041 | |
| | | | | | Base Gasket | | | | |
| | | | | | Head Gasket | | | | |
| Ninja ZX-6RR | 2003 | Head Gasket | 69mm | 600cc-636cc | MLS/C.O.T. .027 | C8701 | \$83.52 | 11004-1383 | |
| | | | 70mm | 618cc-654cc | MLS/C.O.T. .018 | C8701-018 | \$100.22 | 11004-1383 | |
| | | | | | MLS/C.O.T. .027 | C8696 | \$83.52 | 11004-1383 | |
| | | | | | MLS/C.O.T. .018 | C8696-018 | \$100.22 | 11004-1383 | |
| | | | | | Spring Steel .010 | C8692 | \$30.72 | 11061-0041 | |
| Ninja ZX-6RR | 04-06 | Head Gasket | 68mm | 600cc-617cc | MLS/C.O.T. .027 | C8691 | \$87.73 | 11004-0017 | |
| | | | | | MLS/C.O.T. .018 | C8691-018 | \$100.22 | 11004-0017 | |
| | | | | | MLS/C.O.T. .027 | C8697 | \$87.73 | 11004-0017 | |
| | | | | | MLS/C.O.T. .018 | C8697-018 | \$100.22 | 11004-0017 | |
| | | | | | Spring Steel .010 | C8692 | \$30.72 | 11061-0041 | |
| EX-650, KLE650Versys | 06-14 | Head Gasket | 84mm | | MLS/C.O.T. .027 | C8722 | \$51.73 | 11004-0064 | |
| | | | 86mm | | MLS/C.O.T. .027 | C8862 | \$51.73 | 11004-0064 | |
| | | | | | Spring Steel .010 | C8723 | \$9.99 | 11061-0171 | |
| | | | | | Base Gasket | | | | |
| KZ650 | 77-83 | Head Gasket | 65mm | 700cc-720cc | .043 CFM-20 | C8011 | \$51.73 | 11004-1107 | |
| KZ, GPZ750, ZX750 Turbo | 84-85 | Head Gasket | 69.0 mm | 810cc | CFM-20 | C8012 | \$54.34 | 11004-1101 | |
| ZX750 Ninja | 87-90 | Head Gasket | 69.0 mm | 810cc | Copper .010 | C8320 | \$65.64 | 11004-1195 | |
| ZX-7 | 91-95 | Head Gasket | 72.0 mm | 770cc | Spring Steel | C8274 | \$87.73 | 11004-1223 | |
| | | | | | MLS/C.O.T. .018 | C8274-018 | \$95.45 | 11004-1223 | |
| ZX-7R | 91-94 | Base Gasket | 3.210" | 750cc - 950cc | Spring Steel .010 | C8344 | \$30.72 | 11060-1093 | |
| | | | | | Copper .005 | C8290 | \$33.73 | 11060-1093 | |
| | | | | | Copper .010 | C8291 | \$35.38 | 11060-1093 | |
| | | | | | Copper .020 | C8292 | \$33.61 | 11060-1093 | |
| | | | | | Spring Steel | C8428 | \$83.52 | 11004-1307 | |
| ZX-7R | 96-03 | Head Gasket | 73.0 mm | 750cc | Spring Steel | C8428 | \$83.52 | 11004-1307 | |
| | | | | | MLS/C.O.T. .018 | C8428-018 | \$100.22 | 11004-1307 | |
| ZX-7RR | 96-97 | Head Gasket | 75.0 mm | 795cc | Spring Steel | C8429 | \$87.73 | 11004-1307 | |
| | | | | | MLS/C.O.T. .018 | C8429-018 | \$100.22 | 11004-1307 | |
| | | | | | Base Gasket | | | | |
| | | | | | 750cc | Copper .010 | C8524 | \$35.38 | 11060-1705 |
| | | | | | 750cc | Copper .020 | C8525 | \$33.61 | 11060-1705 |
| ZX900/ZX1000 Ninja | 84-86 | Base Gasket | 3.230 | 900cc - 1000cc | Spring Steel .010 | C8346 | \$30.72 | 11009-1505 | |
| | | | | | Copper .005 | C8355 | \$35.38 | 11009-1505 | |
| | | | | | Spring Steel | C8272 | \$87.73 | 11004-1307 | |
| ZX-9R | 94-97 | Head Gasket | 75.0 mm | 950cc | Spring Steel | C8344 | \$30.72 | 11060-1093 | |
| | | | | | Spring Steel .010 | C8344 | \$30.72 | 11060-1093 | |
| | | | | | Copper .005 | C8290 | \$33.73 | 11060-1093 | |
| | | | | | Copper .010 | C8291 | \$35.38 | 11060-1093 | |
| | | | | | Copper .020 | C8292 | \$33.61 | 11060-1093 | |
| ZX-9R | 98-99 | Head Gasket | 77 mm | 950cc | Spring Steel | C8515 | \$83.52 | 11004-1327 | |
| | | | | | Copper .005 | C8505 | \$35.38 | 11060-1818 | |
| ZX-9R | 00-03 | Head Gasket | 77 mm | 900cc | Spring Steel | C8570 | \$87.73 | 11004-1345 | |
| | | | | | MLS/C.O.T. .018 | C8570-018 | \$100.22 | 11004-1345 | |
| | | | | | Spring Steel | C8609 | \$87.73 | 11004-1345 | |
| | | | | | MLS/C.O.T. .018 | C8609-018 | \$100.22 | 11004-1345 | |
| | | | | | Base Gasket | | | | |
| Z1, KZ900, KZ1000 | 73-81 | Head Gasket | 71mm | 1045cc | Copper .010 | C8595 | \$35.38 | 11060-1974 | |
| | | | | | Copper .020 | C8596 | \$35.38 | 11060-1974 | |
| | | | | | MLS/C.O.T. .040 | C8839-040 | \$83.52 | 11004-066/11004-1296/11004-052/11004-1269 | |
| | | | | | MLS/C.O.T. .040 | C8840-040 | \$83.52 | 11004-066/11004-1296/11004-052/11004-1269 | |
| | | | | | MLS/C.O.T. .040 | C8841-040 | \$83.52 | 11004-066/11004-1296/11004-052/11004-1269 | |
| KZ1000, KZ1100, ZX1100, GPZ1100 | 81-05 | Head Gasket | 71mm | 1045cc | MLS/C.O.T. .040 | C8842-040 | \$83.52 | 11004-1222 | |
| | | | | | MLS/C.O.T. .040 | C8843-040 | \$83.52 | 11004-1222 | |
| KZ1000, KZ1100, ZX1100, GPZ1100 | 81-05 | Head Gasket | 73mm | 1105cc | MLS/C.O.T. .040 | C8844-040 | \$83.52 | 11004-1222 | |
| | | | | | MLS/C.O.T. .040 | C8844-040 | \$83.52 | 11004-1222 | |
| KZ1000, KZ1100, ZX1100, GPZ1100 | 81-05 | Head Gasket | 76mm | 1197cc | MLS/C.O.T. .040 | C8845-040 | \$83.52 | 11004-1222 | |
| | | | | | MLS/C.O.T. .040 | C8845-040 | \$83.52 | 11004-1222 | |



STREET·ROAD RACE·STRIP



Cometic Gasket - An Exclusive NASCAR Performance® Product

KAWASAKI

| Model | Year | Type | Bore Size | Displacement / cc | Material | Part # | Price | OEM Part # | | |
|--------------------------------------|-------|-------------|-----------|-------------------|-------------|--------|------------|----------------------------------|---------|-----------------------|
| KZ / GPZ / 10mm Dowel Pin | | Head Gasket | 70 mm | 1015cc | Copper .043 | C8152 | \$65.64 | 11004-1222/11004-1296/11004-1104 | | |
| | | | 71 mm | 1045cc | Copper .043 | C8153 | \$65.64 | 11004-1222/11004-1296/11004-1104 | | |
| | | | 72 mm | 1075cc | Copper .043 | C8154 | \$65.64 | 11004-1222/11004-1296/11004-1104 | | |
| | | | 73 mm | 1105cc | Copper .043 | C8181 | \$65.64 | 11004-1222/11004-1296/11004-1104 | | |
| | | | 75 mm | 1166cc | Copper .043 | C8182 | \$65.64 | 11004-1222/11004-1296/11004-1104 | | |
| | | | 76 mm | 1197cc | Copper .043 | C8156 | \$65.64 | 11004-1222/11004-1296/11004-1104 | | |
| | | | 77 mm | 1229cc | Copper .043 | C8183 | \$65.64 | 11004-1222/11004-1296/11004-1104 | | |
| | | | 78 mm | 1261cc | Copper .043 | C8157 | \$65.64 | 11004-1222/11004-1296/11004-1104 | | |
| | | | 80 mm | 1327cc | Copper .043 | C8158 | \$65.64 | 11004-1222/11004-1296/11004-1104 | | |
| | | | 82 mm | 1393cc | Copper .043 | C8159 | \$65.64 | 11004-1222/11004-1296/11004-1104 | | |
| | | | 83 mm | 1428cc | Copper .043 | C8160 | \$65.64 | 11004-1222/11004-1296/11004-1104 | | |
| KZ / GPZ / D Dowel Pin | | Head Gasket | 82 mm | 1393cc | Copper .043 | C8432 | \$65.64 | 11004-1222/11004-1296/11004-1104 | | |
| | | | 83 mm | 1428cc | Copper .043 | C8433 | \$65.64 | 11004-1222/11004-1296/11004-1104 | | |
| | | | 84 mm | 1463cc | Copper .043 | C8161 | \$65.64 | 11004-1222/11004-1296/11004-1104 | | |
| KZ1000J, GPZ1100, 2 pc | 81-83 | Head Gasket | 72 mm | 1075cc | CFM-20 | C8324 | \$51.73 | 11004-1222/11004-1296/11004-1104 | | |
| | | | 74 mm | 1135cc | CFM-20 | C8325 | \$54.34 | 11004-1222/11004-1296/11004-1104 | | |
| | | | 76 mm | 1197cc | CFM-20 | C8326 | \$54.34 | 11004-1222/11004-1296/11004-1104 | | |
| KZ900-1000, Z1 | 73-81 | Base Gasket | 3.210 | 1000cc-1200cc | Copper .005 | C8094 | \$33.61 | 111009-030/11060-1579 | | |
| | | | | | Copper .010 | C8095 | \$33.61 | 111009-030/11060-1579 | | |
| | | | | | Copper .020 | C8096 | \$33.61 | 111009-030/11060-1579 | | |
| | | | | | | | Fiber .020 | C8093 | \$13.24 | 111009-030/11060-1579 |
| | | | 3.285 | 1200cc-1260cc | Copper .005 | C8098 | \$33.61 | 111009-030/11060-1579 | | |
| | | | | | Copper .010 | C8099 | \$33.61 | 111009-030/11060-1579 | | |
| | | | | | Copper .020 | C8100 | \$33.61 | 111009-030/11060-1579 | | |
| | | | | | | | Fiber .020 | C8097 | \$13.24 | 111009-030/11060-1579 |
| | | | 3.475 | 1261cc-1425cc | Copper .005 | C8102 | \$33.61 | 111009-030/11060-1579 | | |
| | | | | | Copper .010 | C8103 | \$33.61 | 111009-030/11060-1579 | | |
| | | | | | Copper .020 | C8104 | \$33.61 | 111009-030/11060-1579 | | |
| | | | | | | | Fiber .020 | C8101 | \$13.24 | 111009-030/11060-1579 |
| | | | 3.560 | 1425cc-1500cc | Copper .005 | C8121 | \$33.61 | 111009-030/11060-1579 | | |
| | | | | | Copper .010 | C8122 | \$33.61 | 111009-030/11060-1579 | | |
| | | | | | Copper .020 | C8123 | \$33.61 | 111009-030/11060-1579 | | |
| KZ1000J,K,M,P,R, KZ1000GPz,ZX1100GPZ | 81-05 | Base Gasket | 3.120" | 1000cc-1200cc | Fiber .020 | C8865 | \$13.29 | 11009-1207/11060-1828/11060-1067 | | |
| KZ1000J,K,M,P,R, KZ1000GPz,ZX1100GPZ | 81-05 | Base Gasket | 3.285" | 1200cc-1260cc | Fiber .020 | C8866 | \$13.29 | 11009-1207/11060-1828/11060-1067 | | |
| KZ1000J,K,M,P,R, KZ1000GPz,ZX1100GPZ | 81-05 | Base Gasket | 3.475" | 1261cc-1425cc | Fiber .020 | C8867 | \$13.29 | 11009-1207/11060-1828/11060-1067 | | |
| KZ900- 1000 1pc | | Head Gasket | 72.0 mm | 1075cc | CFM-20 | C8018 | \$54.34 | 11004-1222/11004-1296/11004-1104 | | |
| | | | 75.0 mm | 1075cc - 1170cc | CFM-20 | C8017 | \$51.73 | 11004-1222/11004-1296/11004-1104 | | |



STREET·ROAD RACE·STRIP



Cometic Gasket - An Exclusive NASCAR Performance® Product

KAWASAKI

| Model | Year | Type | Bore Size | Displacement / cc | Material | Part # | Price | OEM Part # |
|-----------------------|-------|-----------------|-------------|-------------------|-------------------|-------------------|-------------|----------------------------------|
| KZ900 - 1000 2 pc. | | Head Gasket | 71.0 mm | 1045cc | Copper .043 | C8315 | \$62.51 | 11004-1222/11004-1296/11004-1104 |
| | | | 74.0 mm | 1135cc | Copper .043 | C8244 | \$65.64 | 11004-1222/11004-1296/11004-1104 |
| KZ900 - 1000, GPZ1100 | 81-84 | Head Gasket | 74 mm | 1060cc - 1135cc | CFM-20 | C8019 | \$54.34 | 11004-1222/11004-1296/11004-1104 |
| | | | 76.0 mm | 1170cc - 1200cc | CFM-20 | C8020 | \$54.34 | 11004-1222/11004-1296/11004-1104 |
| | | | 78.0 mm | 1230cc - 1260cc | CFM-20 | C8021 | \$54.34 | 11004-1222/11004-1296/11004-1104 |
| | | | 80.0 mm | 1290cc - 1325cc | CFM-20 | C8022 | \$54.34 | 11004-1222/11004-1296/11004-1104 |
| | | | 83.0 mm | 1385cc, 1425cc | CFM-20 | C8023 | \$54.34 | 11004-1222/11004-1296/11004-1104 |
| ZR1100 | 92-95 | Head Gasket | 82mm | 1321cc | CFM-20 | C8229 | \$54.34 | 11004-1237 |
| ZX1100 Ninja ZX11C | 90-91 | Head Gasket | 78mm | 1109cc | Copper .032 | C8483 | \$65.64 | 11004-1248 |
| GPx1100 ZX11E | 95-97 | | | | | | | |
| ZRX1100 | 99 | | | | | | | |
| Ninja 1000R | 86-87 | Base Gasket | 3.210 | 750cc - 950cc | Spring Steel .010 | C8344 | \$30.72 | 11009-1505 |
| | | | | | Copper .010 | C8291 | \$35.38 | 11009-1505 |
| ZX10 / ZX11 | 88-01 | Head Gasket | 75.0 mm | 972cc | CFM-20 | C8013 | \$54.34 | 11009-1505 |
| | | | 78.0 mm | 1109cc | Copper .032 | C8483 | \$65.64 | 11004-1248 |
| | | | 82.0 mm | 1321cc | CFM-20 | C8229 | \$54.34 | 11004-1248 |
| ZX1000 Ninja, ZX10 | 88-90 | Head Gasket | 75.5 mm | 1040cc | Spring Steel | C8271 | \$87.73 | 11004-1181 |
| | | | Z1000 | 03-09 | Head Gasket | 79 mm | 953cc-997cc | MLS/C.O.T. .018 |
| ZX1000 Ninja ZX-10R | 04-05 | Head Gasket | 81 mm | 998cc-1049cc | MLS/C.O.T. .018 | C8709-018 | \$83.19 | 11004-1385 |
| | | | 76mm | 998cc | MLS/C.O.T. .027 | C8680 | \$87.73 | 11004-0032 |
| | | | 78mm | 998cc-1051cc | MLS/C.O.T. .018 | C8680-018 | \$95.45 | 11004-0032 |
| ZX1000 Ninja ZX-10R | 06-08 | Head Gasket | 76mm | 998cc | MLS/C.O.T. .027 | C8681 | \$87.73 | 11004-0032 |
| | | | | | MLS/C.O.T. .018 | C8681-018 | \$95.45 | 11004-0032 |
| | | | | | MLS/C.O.T. .027 | C8714 | \$87.73 | 11004-0049 |
| ZX1000 Ninja ZX-10R | 11-15 | Head Gasket | 76mm | 998cc-1051cc | MLS/C.O.T. .018 | C8714-018 | \$95.45 | 11004-0049 |
| | | | | | MLS/C.O.T. .027 | C8576 | \$87.73 | 11004-0081 |
| | | | | | MLS/C.O.T. .018 | C8576-018 | \$95.45 | 11004-0081 |
| ZX1000 Ninja ZX-10R | 11-15 | Head Gasket | 77mm | | MLS/C.O.T. .018" | C8848 | \$83.52 | 11004-0094 |
| | | | 79mm | | MLS/C.O.T. .018" | C8849 | \$83.52 | 11004-0094 |
| ZX11 D1, C | 90-01 | Head Gasket | 76 mm | 1052cc | Spring Steel | C8740 | \$83.52 | 11004-1248 |
| | | | 77 mm | 1100cc | Spring Steel | C8603 | \$83.52 | 11004-1248 |
| | | | 77 mm | 1100cc | MLS/C.O.T. .018 | C8603-018 | \$95.45 | 11004-1248 |
| | | | 78 mm | 1109cc | Spring Steel | C8273 | \$83.52 | 11004-1248 |
| | | | 78 mm | 1109cc | MLS/C.O.T. .018 | C8273-018 | \$95.45 | 11004-1248 |
| | | | Base Gasket | 3.290 | 1052cc-1109cc | Spring Steel .010 | C8358 | \$30.72 |
| ZRX1200 | 01-06 | Head Gasket | 80 mm | 1194cc | MLS/C.O.T. .027 | C8711 | \$87.73 | 11004-1377 |
| ZX-12R | 00-03 | Head Gasket | 83 mm | 1199cc | MLS/C.O.T. .030 | C8642 | \$87.73 | 11004-1369 |
| | | | | | MLS/C.O.T. .018 | C8642-018 | \$100.22 | 11004-1369 |
| | | | 84 mm | 1228cc | MLS/C.O.T. .030 | C8573 | \$87.73 | 11004-1369 |
| | | | | | MLS/C.O.T. .018 | C8573-018 | \$100.22 | 11004-1369 |
| | | | 85 mm | 1257cc | MLS/C.O.T. .030 | C8643 | \$87.73 | 11004-1369 |
| | | | | | MLS/C.O.T. .018 | C8643-018 | \$100.22 | 11004-1369 |
| | | | 86 mm | 1287cc | MLS/C.O.T. .030 | C8641 | \$87.73 | 11004-1369 |
| | | MLS/C.O.T. .018 | C8641-018 | \$100.22 | 11004-1369 | | | |
| ZX-14R | 06-15 | Head Gasket | 84 mm | 1352cc | Spring Steel .010 | C8579 | \$30.72 | 11060-1907 |
| | | | 86 mm | 1353cc-1417cc | MLS/C.O.T. .018 | C8460-018 | \$97.73 | 11004-0059 |
| Concours 08-14 | | | 86 mm | 1353cc-1417cc | MLS/C.O.T. .018 | C8621 | \$97.73 | 11004-0059 |
| | | | 87 mm | 1418cc-1450cc | MLS/C.O.T. .018 | C8622 | \$97.73 | 11004-0059 |

Kawasaki Engine Case Rebuild

| Model | Year | Part Description | Part # | Retail | OEM Part # |
|------------------------|-------|-------------------------|--------------|---------|------------|
| Ninja ZX-6R | 95-02 | Engine Case Rebuild | C8303 | \$25.50 | |
| | | Oil Pan | EC075020F | \$15.28 | 11060-1671 |
| | | Clutch Cover | EC076020F | \$6.25 | 11060-1672 |
| | | Ignition Cover | EC077020F | \$3.35 | 11060-1674 |
| | | Dyno Cover | EC078020F | \$5.05 | 11060-1673 |
| Ninja ZX-6R | 03-06 | Engine Case Rebuild | C8685 | \$54.80 | |
| Ninja ZX-6RR ZZR600 | 05-08 | Cam Pulser | EC948032AFM | \$6.30 | 11060-1867 |
| | | Generator | EC949032AFM | \$9.88 | 11060-1851 |
| | | Clutch Cover | EC950032AFM | \$17.84 | 11060-1853 |
| | | Oil Pan | OP160032AFM | \$21.40 | 11060-1996 |
| | | Engine Case Rebuild | C8750AFM | \$53.80 | |
| Ninja ZX-6R | 07-12 | Generator Cover Gasket | EC1190032AFM | \$15.85 | 11061-0249 |
| | | Starter Idle Gear Cover | EC1323032AFM | \$11.87 | 11061-0251 |
| | | Small Starter Cover | EC1191032AFM | \$7.89 | 11061-0250 |
| | | Clutch Cover Gasket | EC1324032AFM | \$24.88 | 11061-0252 |
| | | Oil Pan Gasket | OP271060AFM | \$14.54 | 11061-0253 |



Kawasaki Engine Case Rebuild

| Model | Year | Part Description | Part # | Retail | OEM Part # | | |
|--------------------------------|---------------------|-------------------------------|--------------|-------------------------|--------------|---------|------------|
| EX-650 KLE650 Versys | 06-14 | Engine Case Rebuild | C8721 | \$29.24 | | | |
| | | Generator Cover | EC1175032AFM | \$18.12 | 11061-0165 | | |
| | | Clutch Cover | EC1176032AFM | \$21.53 | 11061-0164 | | |
| | | Transmission Cover | EC1177032AFM | \$7.89 | 11061-0166 | | |
| | | Oil Pan | OP203032AFM | \$14.71 | 11061-0167 | | |
| ZX7, ZX750 | 91-95 | Engine Case Rebuild | C8304 | \$21.63 | | | |
| | | Oil Pan | EC053020F | \$15.28 | 11060-1355 | | |
| | | Clutch Cover | EC054020F | \$6.25 | 11060-1623 | | |
| | | Transmission Cover | EC055020F | \$4.37 | 11060-1660 | | |
| ZX7 | 96-03 | Engine Case Rebuild | C8619 | \$21.63 | | | |
| | | Oil Pan | EC053020F | \$15.28 | 11060-1355 | | |
| | | Transmission Cover | EC055020F | \$4.37 | 11060-1660 | | |
| | | Clutch Cover | EC485020F | \$12.31 | 11060-1704 | | |
| | | ZX9R | 98-99 | Engine Case Rebuild | C8620 | \$37.19 | |
| | | | | Clutch Cover | EC488020F | \$13.29 | 11060-1855 |
| Generator Cover | EC489032AFM | | | \$15.28 | 11060-1854 | | |
| | | Oil Pan | EC490020F | \$14.59 | 11061-1143 | | |
| | | KZ900 - 1000 | 73-78 | Engine Case Rebuild | C8072 | \$36.96 | |
| | | | | Valve Cover | C8263 | \$19.87 | 11023-006 |
| Oil Pan | EC001020F | | | \$13.99 | 11060-1074 | | |
| Clutch Cover | EC002020F | | | \$4.94 | 14046-024 | | |
| Dyno Cover | EC003020F | | | \$5.05 | 11060-1075 | | |
| Transmission Cover | EC004020F | | | \$3.64 | 14058-004 | | |
| Ignition Cover | EC005020F | | | \$3.35 | 11060-1071 | | |
| Starter Cover | EC006020F | | | \$2.04 | 14046-025 | | |
| Cam Chain | EC067031F | | | \$2.04 | 11009-1980 | | |
| Pulser Cover | EC101060F | | | \$5.34 | 14050-006 | | |
| Clutch Cover | EC392020F | | | \$16.69 | | | |
| KZ1000J, GPZ1100 2pc. | 81-83 | | | Engine Case Rebuild | C8306 | \$26.46 | |
| | | | | Valve Cover 79-80 | C8468 | \$19.87 | 11009-1205 |
| | | Valve Cover J Models 81-85 | C8213 | \$19.87 | 11060-1605 | | |
| | | Oil Pan | EC001020F | \$13.99 | 11060-1074 | | |
| | | Clutch Cover | EC060047F | \$6.19 | 11060-1070 | | |
| | | Dyno Cover | EC003020F | \$5.05 | 11060-1075 | | |
| | | Transmission Cover | EC061020F | \$4.47 | 11060-1069 | | |
| | | Ignition Cover | EC005020F | \$3.35 | 11060-1071 | | |
| | | ZX1000 Ninja, ZX-10R | 04-05 | Engine Case Rebuild | C8682 | \$39.80 | |
| | | | | Clutch Cover | EC826032AFM | \$15.44 | 11061-0049 |
| | | | | Starter Idle Gear Cover | EC827032AFM | \$7.33 | 11061-0048 |
| Starter Cover | EC828032AFM | | | \$9.94 | 11061-0047 | | |
| | | Oil Pan | OP142032AFM | \$7.16 | 11061-0065 | | |
| | | ZX1000 Ninja, ZX-10R | 06-08 | Engine Case Rebuild | C8715 | \$54.80 | |
| | | | | Clutch Cover | EC1165032AFM | \$24.88 | 11061-0178 |
| | | | | Starter Idle Gear Cover | EC1116032AFM | \$7.10 | 11061-0177 |
| Starter Cover | EC1164032AFM | | | \$11.87 | 11061-0176 | | |
| Oil Pan | OP204032AFM | | | \$24.93 | 11061-0180 | | |
| | | Generator Cover | EC1117032AFM | \$11.87 | 11061-0179 | | |
| | | ZX1000 Ninja ZX-10R | 11-15 | Engine Case Rebuild Kit | C8846 | \$54.80 | |
| | | | | Clutch Cover Gasket | EC1905032AFM | \$24.88 | 11061-0735 |
| | | | | Generator Cover Gasket | EC1903032AFM | \$11.87 | 11061-0441 |
| Oil Pan Gasket | OP447032AFM | | | \$24.93 | 11061-0747 | | |
| Starter Cover Gasket | EC1904032AFM | | | \$7.10 | 11061-0442 | | |
| Starter Idle Gear Cover Gasket | EC1902032AFM | | | \$7.10 | 14092-0153 | | |
| ZX11 D1, C | 90-01 | | | Engine Case Rebuild | C8305 | \$25.50 | |
| | | Dyno Cover | EC056020F | \$5.05 | 11009-1863 | | |
| | | Clutch Cover | EC057020F | \$6.25 | 11061-1154 | | |
| | | Transmission Cover | EC058020F | \$4.37 | 11009-1982 | | |
| | | Oil Pan | EC059020F | \$13.99 | 11009-1981 | | |
| ZX-12R | 00-03 | Engine Case Rebuild | C8497 | \$42.87 | | | |
| | | Generator Cover | EC881032AFM | \$11.36 | 11060-1911 | | |
| | | Clutch Cover | EC882032AFM | \$15.85 | 11060-1910 | | |
| | | Breather Cover | EC884032AFM | \$4.65 | 11061-1087 | | |
| | | Oil Pan | OP149032AFM | \$16.64 | 11060-1909 | | |
| | | Ninja ZX-14 Concours 08-14 | 06-15 | Engine Case Rebuild | C8713 | \$54.80 | |
| Clutch Cover | EC1159032AFM | | | \$20.22 | 11061-0198 | | |
| 06-12 | Crank Case Breather | | EC1160032AFM | \$15.44 | 11061-0200 | | |
| | Generator Cover | | EC1161032AFM | \$15.44 | 11061-0197 | | |
| | Pulser Cover | | EC1162032AFM | \$11.87 | 92055-0086 | | |
| | Oil Pan | | OP197032AFM | \$28.34 | 11061-0199 | | |
| | Clutch Cover | | EC392020F | \$16.69 | | | |



STREET·ROAD RACE·STRIP



Cometic Gasket - An Exclusive NASCAR Performance® Product

KTM

| Model | Year | Type | Bore Size | Displacement / cc | Material | Part # | Price | OEM Part # |
|-----------------|------|-------------|-----------|-------------------|--------------------|--------|---------|-------------|
| RC390, 390 Duke | 13 | Head Gasket | 89mm | | MLS/C.O.T. .027" | C8897 | \$33.23 | 9023003600 |
| | | Head Gasket | 91mm | | MLS/C.O.T. .027" | C8898 | \$33.23 | 9023003600 |
| | | Base Gasket | | | Spring Steel .014" | C8899 | \$11.87 | 90230035000 |

POLARIS

| Model | Year | Type | Bore Size | Displacement / cc | Material | Part # | Price | OEM Part # |
|--------------|------|-------------|-----------|-------------------|--------------|--------|----------|-----------------|
| Victory V92C | | Head Gasket | 97.0 mm | 754cc | Spring Steel | C8652 | \$182.22 | 5244306/5344307 |
| Victory V92C | | Head Gasket | 101.0 mm | 817cc | Spring Steel | C8653 | \$182.22 | 5244306/5344307 |

SUZUKI

| Model | Year | Type | Bore Size | Displacement / cc | Material | Part # | Price | OEM Part # | | | | | |
|-----------------------------------|-----------|-------------|-------------|-------------------|--------------------|-----------|-------------|-------------------------|------------------|--------------|-------|---------|-------------|
| GS 550 2 Valve | 77-86 | Head Gasket | 60mm | 610cc-630cc | CFM-20 .043 | C8024 | \$51.73 | 11141-47086-H17 | | | | | |
| GSX 600 Katana, GSF 600 Bandit | 88-04 | Head Gasket | 66.5mm | 606cc-676cc | CFM-20 .043 | C8025 | \$51.73 | 11141-19C03 | | | | | |
| GSX-R600 | 97-00 | Head Gasket | | 65.5mm 600cc | Spring Steel | C8413 | \$83.52 | 11141-34E01 | | | | | |
| | | Base Gasket | | 600cc | Spring Steel .010 | C8422 | \$30.72 | 11241-33E00 | | | | | |
| GSXR600 | 01-03 | Head Gasket | 68.0 mm | | Spring Steel | C8644 | \$87.73 | 11141-39F00 | | | | | |
| | | | | | MLS/C.O.T. .018 | C8644-018 | \$100.22 | 11141-39F00 | | | | | |
| | | | | | Spring Steel | C8646 | \$87.73 | 11141-39F00 | | | | | |
| | | | | | Spring Steel | C8645 | \$87.73 | 11141-39F00 | | | | | |
| GSXR600 | 04-05 | Head Gasket | 68 mm | 600cc-617cc | MLS/C.O.T. .018 | C8645-018 | \$100.22 | 11141-39F00 | | | | | |
| | | | | | MLS/C.O.T. .030 | C8632 | \$87.73 | 11141-29G00 | | | | | |
| | | | | | MLS/C.O.T. .018 | C8632-018 | \$100.22 | 11141-29G00 | | | | | |
| | | | | | MLS/C.O.T. .030 | C8724 | \$87.73 | 11141-29G00 | | | | | |
| GSXR600 | 06-15 | Head Gasket | 68 mm | | MLS/C.O.T. .018 | C8724-018 | \$100.22 | 11141-29G00 | | | | | |
| | | | | | MLS/C.O.T. .027 | C8302 | \$87.73 | 11141-01H00 | | | | | |
| | | | | | MLS/C.O.T. .018 | C8302-018 | \$100.22 | 11141-01H00 | | | | | |
| | | | | | MLS/C.O.T. .027 | C8293 | \$83.52 | 11141-01H00 | | | | | |
| SV650 | 99-09 | Head Gasket | 81.0 mm | 635cc | Spring Steel | C8614 | \$92.84 | 11141-20F00 | | | | | |
| | | | | | MLS/C.O.T. .018 | C8614-018 | \$104.77 | 11141-20F00 | | | | | |
| | | | | | Spring Steel | C8600 | \$92.84 | 11141-20F00 | | | | | |
| | | | | | MLS/C.O.T. .018 | C8600-018 | \$109.99 | 11141-20F00 | | | | | |
| | | | | | Spring Steel | C8593 | \$97.49 | 11141-20F00 | | | | | |
| | | | | | MLS/C.O.T. .018 | C8593-018 | \$104.77 | 11141-20F00 | | | | | |
| | | | | | Spring Steel | C8613 | \$92.84 | 11141-20F00 | | | | | |
| | | | | | MLS/C.O.T. .018 | C8613-018 | \$109.99 | 11141-20F00 | | | | | |
| | | | | | Copper .005 | C8615 | \$35.38 | 11241-19F00/11242-19F00 | | | | | |
| | | | | | Copper .020 | C8617 | \$35.38 | 11241-19F00/11242-19F00 | | | | | |
| GSXR750 | 86-87 | Head Gasket | 71 mm | 756cc thru 771cc | Spring Steel .020" | C8771 | \$35.38 | 11241-19F00/11242-19F00 | | | | | |
| | | | | | Spiral Wound | C8746 | \$13.66 | 11241-19F00/11242-19F00 | | | | | |
| | | | | | Spring Steel | C8466 | \$83.52 | 11141-17D10 | | | | | |
| | | | | | Spring Steel | C8464 | \$83.52 | 11141-17D10 | | | | | |
| | | | | | Spring Steel | C8463 | \$87.73 | 11141-27A01 | | | | | |
| | | | | | GSXR750 | 88-89 | Head Gasket | 74 mm | 750cc thru 771cc | Spring Steel | C8415 | \$83.52 | 11141-17C02 |
| | | | | | | | | | | Spring Steel | C8466 | \$83.52 | 11141-27A01 |
| | | | | | | | | | | Spring Steel | C8463 | \$87.73 | 11141-17D10 |
| | | | | | GSXR750 | 90-92 | Head Gasket | 71 mm | 756cc thru 771cc | Spring Steel | C8466 | \$83.52 | 11141-17D10 |
| | | | | | | | | | | Spring Steel | C8463 | \$87.73 | 11141-17D10 |
| Spring Steel | C8464 | \$83.52 | 11141-17D10 | | | | | | | | | | |
| GSXR750 | 93-95 | Head Gasket | 75 mm | 860cc | Spring Steel | C8337 | \$83.52 | 11141-17E01 | | | | | |
| | | | | | Spring Steel | C8338 | \$87.73 | 11141-17E01 | | | | | |
| | | | | | Spring Steel | C8387 | \$83.52 | 11141-33E00-095 | | | | | |
| GSXR750 | 96-99 | Head Gasket | 72 mm | 750cc | MLS/C.O.T. .018 | C8387-018 | \$100.22 | 11141-33E00-095 | | | | | |
| | | | | | Spring Steel | C8414 | \$87.73 | 11141-33E00-095 | | | | | |
| | | | | | MLS/C.O.T. .018 | C8414-018 | \$100.22 | 11141-33E00-095 | | | | | |
| | | | | | Spring Steel | C8445 | \$87.73 | 11141-33E00-095 | | | | | |
| | | | | | MLS/C.O.T. .018 | C8445-018 | \$100.22 | 11141-33E00-095 | | | | | |
| | | | | | .010 Spring Steel | C8421 | \$30.72 | 11141-33E00-095 | | | | | |
| GSXR750 | 00-05 | Head Gasket | 73 mm | 750-770 | Spring Steel | C8663 | \$83.52 | 11141-35F00 | | | | | |
| | | | | | MLS/C.O.T. .018 | C8663-018 | \$95.45 | 11141-35F00 | | | | | |
| | | | | | Spring Steel | C8574 | \$83.52 | 11141-35F00 | | | | | |
| | | | | | MLS/C.O.T. .018 | C8574-018 | \$100.22 | 11141-35F00 | | | | | |
| | | | | | Spring Steel | C8214 | \$87.73 | 11141-35F00 | | | | | |
| | | | | | MLS/C.O.T. .018 | C8214-018 | \$100.22 | 11141-35F00 | | | | | |
| | | | | | Spring Steel | C8602 | \$87.73 | 11141-35F00 | | | | | |
| MLS/C.O.T. .018 | C8602-018 | \$100.22 | 11141-35F00 | | | | | | | | | | |



STREET·ROAD RACE·STRIP



Cometic Gasket - An Exclusive NASCAR Performance® Product

SUZUKI

| Model | Year | Type | Bore Size | Displacement / cc | Material | Part # | Price | OEM Part # | |
|--------------------------------------|-------|-------------|-------------|-------------------|-------------------|-------------|----------|-------------------------|--|
| GSXR750 | 06-14 | Head Gasket | 70 mm | 749cc | MLS/C.O.T. .027 | C8717 | \$87.73 | 11141-02H00 | |
| | | | 72 mm | 793cc | MLS/C.O.T. .018 | C8718 | \$87.73 | 11141-02H00 | |
| | | | | | MLS/C.O.T. .027 | C8717-018 | \$100.22 | 11141-02H00 | |
| GSXR750F, Katana | 88-97 | Head Gasket | 74 mm | 750cc thru 771cc | Spring Steel | C8415 | \$83.52 | 11141-17C02 | |
| | 93-95 | Head Gasket | 71 mm | 750cc thru 771cc | Spring Steel | C8276 | \$83.52 | 11141-17E01 | |
| GSXR750W | | Base Gasket | 83 mm | 771cc-907cc | Copper .020 | C8137 | \$35.38 | 11241-17E00 | |
| GS750 2 Valve | | Head Gasket | 69 mm | 844cc | CFM-20 | C8028 | \$54.34 | 11141-49410 | |
| GS750 2 Valve, 2.900 Bore | | Base Gasket | 2.900 | 750cc | Fiber .020 | C8528 | \$13.97 | 11241-45110-H17 | |
| GS750 4 Valve | | Head Gasket | 70 mm | 747cc thru 816cc | CFM-20 | C8027 | \$54.34 | 11141-45410 | |
| GS750 4 Valve, 2.953 Bore | | Base Gasket | 2.953 | 750cc | Fiber .020 | C8549 | \$13.97 | 11241-45401-H17 | |
| RF900 | 94-98 | Head Gasket | 75.0 mm | 972cc | Spring Steel | C8338 | \$87.73 | 11141-31E00 | |
| | | Head Gasket | 77.0 mm | 1045cc | Spring Steel | C8277 | \$87.73 | 11141-31E00 | |
| TL1000 R/S V-Twin | 97-03 | Head Gasket | 99.0 mm | 1000cc | MLS/C.O.T. .030 | C8502 | \$87.73 | 11141-02F01 | |
| SV1000S | 03-06 | Base Gasket | 4.450 mm | 1000cc | Spring Steel .010 | C8509 | \$41.68 | 11241-02F01/11242-02F01 | |
| GS1000 2 Valve | 78-81 | Head Gasket | 73.5mm | 749cc | CFM-20 .043 | C8030 | \$54.34 | 11141-49410 | |
| | | | | | Copper .043 | C8408 | \$66.64 | 11141-49410 | |
| | | | | | Copper .020 | C8364 | \$35.38 | 11241-49000-H17 | |
| GSXR1000 | 00-04 | Head Gasket | 73 mm | 1000-988cc | MLS/C.O.T. .030 | C8663 | \$83.52 | 11141-35F00 | |
| | | | | | MLS/C.O.T. .018 | C8663-018 | \$95.45 | 11141-35F00 | |
| | | | 74 mm | | MLS/C.O.T. .030 | C8574 | \$83.52 | 11141-35F00 | |
| | | | | | MLS/C.O.T. .018 | C8574-018 | \$100.22 | 11141-35F00 | |
| | | | 75 mm | 1000-1043cc | MLS/C.O.T. .030 | C8214 | \$87.73 | 11141-35F00 | |
| | | | | | MLS/C.O.T. .018 | C8214-018 | \$100.22 | 11141-35F00 | |
| GSXR1000 | 05-08 | Head Gasket | 76 mm | 1000-1071cc | MLS/C.O.T. .030 | C8602 | \$87.73 | 11141-35F00 | |
| | | | | | MLS/C.O.T. .018 | C8602-018 | \$100.22 | 11141-35F00 | |
| | | | | | MLS/C.O.T. .030 | C8214 | \$87.73 | 11141-40F00 | |
| GSXR1000 | 09-15 | Head Gasket | 75 mm | 1000cc-1043cc | MLS/C.O.T. .018 | C8214-018 | \$100.22 | 11141-40F00 | |
| | | | | | MLS/C.O.T. .030 | C8602 | \$87.73 | 11141-40F00 | |
| | | | | | MLS/C.O.T. .018 | C8602-018 | \$100.22 | 11141-40F00 | |
| GSXR1000 | 09-15 | Head Gasket | 74.5 mm | 1000cc | MLS/C.O.T. .027 | C8772 | \$83.52 | 11141-47H01 | |
| | | | 76 mm | 1000-1071cc | MLS/C.O.T. .027 | C8773 | \$83.52 | 11141-47H01 | |
| GS1100 4 Valve | | Head Gasket | 75 mm | 1133cc, 1168cc | CFM-20 .043 | C8031 | \$54.34 | | |
| | | | 84 mm | 1385cc-1465cc | CFM-20 .043 | C8035 | \$54.34 | | |
| GS1100/1150 | | Head Gasket | 75 mm | 1100cc-1166cc | CFM-20 .043 | C8031 | \$54.34 | | |
| | | | Base Gasket | 3.130 | 1100cc-1168cc | Copper .005 | C8110 | \$33.68 | |
| | | | | | | Copper .010 | C8111 | \$33.68 | |
| | | | | | | Copper .020 | C8112 | \$33.68 | |
| | | | | | | Fiber .020 | C8109 | \$13.29 | |
| | | | | | | Copper .005 | C8114 | \$33.68 | |
| | | | | | | Copper .010 | C8115 | \$33.68 | |
| | | | | | | Copper .020 | C8116 | \$33.68 | |
| | | | | | | Fiber .020 | C8113 | \$13.29 | |
| | | | | | | Copper .005 | C8177 | \$33.68 | |
| | | | | | | Copper .010 | C8178 | \$33.68 | |
| | | | | | | Copper .020 | C8179 | \$33.68 | |
| | | | | | | Fiber .020 | C8180 | \$13.29 | |
| | | | | | | Copper .005 | C8118 | \$33.68 | |
| | | | | | | Copper .010 | C8119 | \$33.68 | |
| | | | | | | Copper .020 | C8120 | \$33.68 | |
| | | | | | | Fiber .020 | C8117 | \$13.29 | |
| | | | | Copper .005 | C8375 | \$33.68 | | | |
| | | | | Copper .010 | C8376 | \$33.68 | | | |
| | | | | Copper .020 | C8377 | \$33.68 | | | |
| GS1100/1150 / 6mm Dowel Head Gasket | | 85 mm | 1498cc | Copper .043 | C8187 | \$65.64 | | | |
| | | | 87 mm | 1568cc | Copper .043 | C8171 | \$65.64 | | |
| GS1100/1150 / 8mm Dowel Head Gasket | | 85 mm | 1498cc | Copper .043 | MLS/C.O.T. .045 | C8734-045 | \$87.73 | | |
| | | | 87 mm | 1568cc | C8439 | \$65.64 | | | |
| GS1100/1150 / D Dowel PinHead Gasket | | 82 mm | 1393cc | Copper .043 | C8470 | \$65.64 | | | |
| | | | 83 mm | 1428cc | Copper .043 | C8471 | \$65.64 | | |
| | | | 83 mm | 1428cc | MLS/C.O.T. .045 | C8732-045 | \$87.73 | | |
| | | | 85 mm | 1498cc | Copper .043 | C8473 | \$65.64 | | |
| | | | 85 mm | 1498cc | MLS/C.O.T. .045 | C8733-045 | \$87.73 | | |
| | | | | | | | | | |



STREET·ROAD RACE·STRIP



Cometic Gasket - An Exclusive NASCAR Performance® Product

SUZUKI

| Model | Year | Type | Bore Size | Displacement / cc | Material | Part # | Price | OEM Part # | | | | | |
|---------------------------------------|--------|-----------------|------------------------------|-------------------|-------------------|-----------|--------------|-----------------|-----------------|-----------------|-------|---------|--|
| GS1100/1150 11mm Dowel Head Gasket | | 72 mm | 1100cc | Copper .043 | C8163 | \$65.64 | | | | | | | |
| | | | 75 mm | 1166cc | Copper .043 | C8185 | \$65.64 | | | | | | |
| | | | 75mm | 1166cc | MLS/C.O.T. .045 | C8728-045 | \$87.73 | | | | | | |
| | | | 76 mm | 1197cc | Copper .043 | C8165 | \$65.64 | | | | | | |
| | | | 76 mm | 1197cc | MLS/C.O.T. .045 | C8729-045 | \$87.73 | | | | | | |
| | | | 77 mm | 1229cc | Copper .043 | C8186 | \$65.64 | | | | | | |
| | | | 79 mm | 1290cc | Copper .043 | C8167 | \$65.64 | | | | | | |
| | | | 79 mm | 1290cc | MLS/C.O.T. .045 | C8730-045 | \$87.73 | | | | | | |
| | | | 78 mm | 1261cc | Copper .043 | C8166 | \$65.64 | | | | | | |
| | | | 80 mm | 1327cc | Copper .043 | C8168 | \$65.64 | | | | | | |
| | | | 80 mm | 1327cc | MLS/C.O.T. .045 | C8731-045 | \$87.73 | | | | | | |
| | | | 82 mm | 1393cc | Copper .043 | C8169 | \$65.64 | | | | | | |
| | | | 83 mm | 1428cc | Copper .043 | C8170 | \$65.64 | | | | | | |
| | | | 84 mm | 1465cc | Fiber .043 | C8035 | \$54.34 | | | | | | |
| | | | GS1100/1150 No Dowel Pins | | Head Gasket | 89 mm | 1642cc | MLS/C.O.T. .045 | C8735-045 | \$87.73 | | | |
| GSXR1100 | 86-88 | Head Gasket | 78 mm | 1109cc | MLS/C.O.T. .030 | C8277 | \$87.73 | | | | | | |
| | | | 81 mm | 1196cc | | C8321 | \$87.73 | | | | | | |
| | | | 83 mm | 1255cc | | C8278 | \$87.73 | | | | | | |
| GSXR1100 D Dowel Pins | 86-88 | Head Gasket | 78 mm | 1109cc | Copper .032 | C8231 | \$65.64 | | | | | | |
| | | | 80 mm | 1166cc | | C8232 | \$65.64 | | | | | | |
| | | | 83 mm | 1255cc | | C8234 | \$65.64 | | | | | | |
| | | | 84 mm | 1286cc | | C8235 | \$62.51 | | | | | | |
| | | | 85 mm | 1317cc | | C8435 | \$65.64 | | | | | | |
| GSXR1100 6mm Dowel Pins | 86-88 | Head Gasket | 85 mm | 1317cc | Copper .032 | C8236 | \$65.64 | | | | | | |
| GSXR1100 | 89-92 | Head Gasket | 78 mm | 1127cc | Spring Steel | C8322 | \$87.73 | | | | | | |
| | | | | | Copper .032 | C8189 | \$65.64 | | | | | | |
| | | | 80 mm | 1186cc | CFM-20 | C8037 | \$54.34 | | | | | | |
| | | | | | Copper .032 | C8190 | \$65.64 | | | | | | |
| | | | | | Spring Steel | C8368 | \$87.73 | | | | | | |
| | | | 81 mm | 1216cc | Copper .032 | C8191 | \$65.64 | | | | | | |
| | | | | | Spring Steel | C8279 | \$87.73 | | | | | | |
| | | | 82 mm | 1245cc | Copper .032 | C8243 | \$65.64 | | | | | | |
| 83 mm | 1276cc | Copper .032 | C8192 | \$65.64 | | | | | | | | | |
| | | | | CFM-20 | C8036 | \$54.34 | | | | | | | |
| GSXR1100 11 mm Dowel Pins | 89-92 | Head Gasket | 82 mm | 1246cc | Spring Steel | C8391 | \$87.73 | | | | | | |
| GSXR110 6mm Dowel Pin | 89-92 | Head Gasket | 85 mm | 1340cc | Copper .032 | C8437 | \$65.64 | | | | | | |
| | | | 86 mm | 1377cc | Copper .032 | C8195 | \$65.64 | | | | | | |
| GSXR1100 D Dowel Pin | 89-92 | Head Gasket | 83 mm | 1276cc | Spring Steel | C8323 | \$87.73 | | | | | | |
| | | | 85 mm | 1340cc | Copper .032 | C8194 | \$65.64 | | | | | | |
| | | | 85 mm | 1340 cc | MLS/C.O.T. .030 | C8340 | \$83.52 | | | | | | |
| GSXR1100 | 86-92 | Base Gasket | 3.370 | 1050cc - 1186cc | Copper .005 | C8297 | \$35.38 | | | | | | |
| | | | | | Copper .020 | C8462 | \$35.38 | | | | | | |
| | | | | | Spring Steel .010 | C8372 | \$30.72 | | | | | | |
| | | | 3.460 | 1186cc - 1255cc | Copper .010 | C8069 | \$35.38 | | | | | | |
| | | | | | Fiber .020 | C8298 | \$13.97 | | | | | | |
| | | | | | Copper .010 | C8070 | \$35.38 | | | | | | |
| | | | 3.560 | 1255cc - 1340cc | Copper .020 | C8526 | \$35.38 | | | | | | |
| | | | | | Spring Steel .010 | C8373 | \$30.72 | | | | | | |
| | | | | | Copper .005 | C8203 | \$35.38 | | | | | | |
| | | | | | Copper .005 | C8246 | \$35.38 | | | | | | |
| | | | | | Copper .020 | C8446 | \$35.38 | | | | | | |
| | | | | | Copper .010 | C8247 | \$35.38 | | | | | | |
| | | | | | Spring Steel .010 | C8374 | \$30.72 | | | | | | |
| | | | | | GSXR1100 | 93-98 | Head Gasket | 77 mm | 1074cc - 1117cc | MLS/C.O.T. .030 | C8280 | \$83.52 | |
| | | | | | | | | 78 mm | 1147cc | MLS/C.O.T. .030 | C8478 | \$83.52 | |
| 78 mm | 1147cc | Copper .032 | C8479 | \$62.51 | | | | | | | | | |
| 79.5 mm | 1192cc | MLS/C.O.T. .030 | C8281 | \$83.52 | | | | | | | | | |
| 79.5 mm | 1192cc | Copper .032 | C8480 | \$62.51 | | | | | | | | | |
| 79.75 mm | 1198cc | Copper .032 | C8481 | \$62.51 | | | | | | | | | |
| Base Gasket | 3.265 | 1100cc | Spring Steel .010 | C8370 | | | | \$29.24 | | | | | |
| | 3.310 | 1100cc - 1200cc | Spring Steel .010 | C8371 | | | | \$29.24 | | | | | |
| | | | Copper.005 | C8307 | | | | \$33.68 | | | | | |
| | | | Copper .010 | C8308 | | | | \$33.68 | | | | | |
| | | | Copper .020 | C8444 | | | \$33.68 | | | | | | |
| GSF1200SX Bandit | 98-00 | Head Gasket | 80 mm | 1186cc | | | Spring Steel | C8368 | \$87.73 | 11141-32F01 | | | |
| | | | 81 mm | 1216cc | | | Spring Steel | C8279 | \$87.73 | 11141-32F01 | | | |
| GSF1200SX 11 mm Dowel | 98-00 | Head Gasket | 82 mm | 1246cc | | | Spring Steel | C8391 | \$87.73 | 11141-32F01 | | | |
| | | | | | | | | | | | | | |
| GSF1200SX D Dowel Pin | 98-00 | Head Gasket | 83 mm | 1276cc | Spring Steel | C8323 | \$87.73 | 11141-32F01 | | | | | |



STREET·ROAD RACE·STRIP



Cometic Gasket - An Exclusive NASCAR Performance® Product

SUZUKI

| Model | Year | Type | Bore Size | Displacement / cc | Material | Part # | Price | OEM Part # | | |
|-------------------|-------|-------------|---------------------|---------------------|---------------------|---------------|-----------------------------------|-------------|----------|-------------|
| GSX1300R Hayabusa | 99-14 | Head Gasket | 81 mm | 1299cc | MLS/C.O.T. .030 | C8656 | \$83.52 | 11141-24F00 | | |
| | | | 81 mm w/13 mm studs | | MLS/C.O.T. .018 | C8656-018 | \$95.45 | 11141-24F00 | | |
| | | | | | 82 mm | | MLS/C.O.T. .030 | C8218 | \$83.52 | 11141-24F00 |
| | | | | | 83 mm | 1364cc | MLS/C.O.T. .030 | C8660 | \$83.52 | 11141-24F00 |
| | | | | | | | MLS/C.O.T. .030 | C8657 | \$83.52 | 11141-24F00 |
| | | | | | 83 mm w/13 mm studs | | MLS/C.O.T. .018 | C8657-018 | \$95.45 | 11141-24F00 |
| | | | | | | | MLS/C.O.T. .030 | C8219 | \$83.52 | 11141-24F00 |
| | | | | | 84 mm | 1396cc | MLS/C.O.T. .030 | C8658 | \$83.52 | 11141-24F00 |
| | | | | | | | MLS/C.O.T. .018 | C8658-018 | \$95.45 | 11141-24F00 |
| | | | | | 84 mm w/13 mm studs | | MLS/C.O.T. .030 | C8220 | \$83.52 | 11141-24F00 |
| | | | | | 85 mm | 1428cc | MLS/C.O.T. .030 | C8659 | \$83.52 | 11141-24F00 |
| | | | | | | | MLS/C.O.T. .018 | C8659-018 | \$95.45 | 11141-24F00 |
| | | | | Base Gasket | 93 mm | 1299cc-1428cc | Spring Steel .010 | C8585 | \$29.24 | 11141-24F00 |
| | | | | | 93 mm w/13mm studs | 1299cc-1428cc | Spring Steel .010 | C8747 | \$29.24 | 11210-24F00 |
| | | | | | 93 mm | 1299cc-1428cc | Aluminum .080 | C7121 | \$55.40 | 11141-24F00 |
| | | | | Base Shim Kit .060" | 93mm | 1299cc-1428cc | (1) .040" Alum (2) .010" Steel | C8776 | \$78.18 | |
| | | | | Base Shim Kit .100" | 93mm | 1299cc-1428cc | (1) .080" Alum (2) .010" Steel | C8777 | \$101.61 | |

Suzuki Engine Case Rebuild

| Model | Year | Part Description | Part # | Retail | OEM Part # |
|--------------------|-------|-------------------------|--------------|---------|-------------|
| GSX-R600 | 97-00 | Engine Case Rebuild | C8592 | \$26.51 | |
| | | Magneto Cover | EC090031F | \$4.94 | 11483-33E01 |
| | | Clutch Cover | EC091020F | \$8.52 | 11482-33E01 |
| | | Oil Pan | EC092020F | \$8.52 | 11489-33E00 |
| | | Starter Clutch Cover | EC093031F | \$4.94 | 11491-33E02 |
| | | Starter Cover | EC094031F | \$2.04 | 11492-33E00 |
| | | Starter Clutch Cover | EC410020F | \$4.94 | 11381-33E02 |
| | | Engine Case Rebuild | C8742 | \$44.47 | |
| | | Magneto Cover | EC1278032AFM | \$11.87 | 11483-01H00 |
| | | Clutch Cover | EC1276032AFM | \$14.25 | 11482-01H00 |
| GSX-R600, GSX-R750 | 06-15 | Oil Pan | OP235032AFM | \$24.93 | 11489-01H01 |
| | | Cam Chain Tens.(06-07) | EC745032AFM | \$3.35 | 12837-24F10 |
| | | Cam Chain Tens.(08-09) | EC1247018AFM | \$2.04 | 12837-02H00 |
| | | Breather Cover | EC1277032AFM | \$4.65 | 11484-01H00 |
| | | Engine Case Rebuild | C8689 | \$44.47 | |
| | | Starter Idle Gear Cover | EC520032AFM | \$6.58 | 11492-33E00 |
| | | Starter Clutch | EC521032AFM | \$7.95 | 11491-33E02 |
| GSX-R600, GSX-R750 | 04-05 | Breather Cover | EC522032AFM | \$4.65 | 11484-35F00 |
| | | Cam Chain | EC945032AFM | \$3.52 | 12837-18G00 |
| | | Magneto Cover | EC946032AFM | \$8.29 | 11483-18G00 |
| | | Clutch Cover | EC947032AFM | \$14.25 | 12837-24F10 |
| | | Engine Case Rebuild | C8206 | \$54.82 | |
| | | Starter Idle Gear Cover | EC520032AFM | \$6.58 | 11492-33E00 |
| | | Starter Clutch Cover | EC521032AFM | \$7.95 | 11491-33E00 |
| | | Cam Chain Tensioner | EC523032AFM | \$3.07 | 12837-35F00 |
| | | Magneto Cover | EC519032AFM | \$10.15 | 11483-35F00 |
| | | Clutch Cover Gasket | EC518032AFM | \$15.90 | 11482-40F00 |
| GSX-R750 | 96-99 | Oil Pan Gasket | OP071060AFM | \$14.54 | 11489-35F00 |
| | | Engine Case Rebuild | C8403 | \$26.51 | |
| | | Magneto Cover | EC090031F | \$4.94 | 11483-33E01 |
| | | Clutch Cover | EC091020F | \$8.52 | 11482-33E01 |
| | | Oil Pan | EC092020F | \$8.52 | 11489-33E01 |
| | | Starter Clutch Cover | EC093031F | \$4.94 | 11491-33E02 |
| | | Starter Idle Gear Cover | EC094031F | \$2.04 | 11492-33E00 |
| | | Oil Strainer Cover | EC095031F | \$2.04 | 16527-33E00 |
| | | Cam Chain | EC377020F | \$3.35 | 12837-24A10 |
| | | Engine Case Rebuild | C8143 | \$19.87 | |
| GSX-R750 LC | 93-95 | Oil Pan | EC021020F | \$5.73 | 11489-17E01 |
| | | Clutch Cover | EC022020F | \$4.94 | 11482-17E00 |
| GSX-R600 | 92-93 | Ignition Cover | EC023020F | \$2.61 | 11491-17E01 |
| | | Cam Chain | EC065020F | \$2.44 | 12837-27A10 |
| GSX-750F | 89-96 | Engine Case Rebuild | C8423 | \$25.21 | |
| KATANA | | Oil Pan | EC011020F | \$7.38 | 11489-27A21 |
| | | Clutch Cover | EC012020F | \$6.25 | 11482-27A20 |
| GSX-R750 | 86-92 | Ignition Cover | EC013020F | \$3.35 | 11491-27A30 |
| | | Dyno Cover | EC014020F | \$6.25 | 11483-27A20 |
| | | Oil Strainer Cover | EC040020F | \$2.44 | 16528-27A20 |
| | | Cam Chain | EC065020F | \$2.44 | 12837-27A10 |
| | | Clutch Cover | EC392020F | \$16.69 | |

All Component Parts can be purchased individually.



STREET-ROAD RACE-STRIP



Cometic Gasket - An Exclusive NASCAR Performance® Product

Suzuki Engine Case Rebuild

| Model | Year | Part Description | Part # | Retail | OEM Part # | | |
|----------------------------|--------------|-----------------------------|--------------|----------------------------|-----------------|---------|-------------|
| GSX-R 1100 | 86-92 | Engine Case Rebuild | C8081 | \$30.49 | | | |
| | | AFM Engine Case Rebuild | C8081AFM | \$30.49 | | | |
| | | Cam Chain | EC065020F | \$2.44 | 12837-27A00 | | |
| | | Oil Pick Up | EC040020F | \$2.44 | 16528-27A20 | | |
| | | Magneto Cover | EC027020F | \$4.88 | 11483-27A20 | | |
| | | Ignition Cover | EC013020F | \$3.35 | 11491-27A20 | | |
| | | Clutch Cover | EC012020F | \$6.25 | 11482-27A20 | | |
| | | Breather Cover | EC085039F | \$6.19 | 11177-48B00-H17 | | |
| | | Oil Pan | EC011020F | \$7.38 | 11489-27A20 | | |
| | | GSX-R1100 | 93-98 | Engine Case Rebuild | C8144 | \$19.87 | |
| Clutch Cover | EC022020F | | | \$4.94 | 11482-17E00 | | |
| Ignition Cover | EC023020F | | | \$2.61 | 11491-17E01 | | |
| Oil Pan | EC028020F | | | \$5.73 | 11489-17E01 | | |
| Cam Chain | EC065020F | | | \$2.44 | 12837-27A10 | | |
| GS1100/1150 | 82-84 | Engine Case Rebuild | C8073 | \$15.90 | | | |
| | | Oil Pan | EC007020F | \$5.91 | 11482-49201-H17 | | |
| | | Clutch Cover | EC008020F | \$4.94 | 11482-49202-H17 | | |
| | | Generator Cover | EC009020F | \$5.17 | 11381-00A00 | | |
| | | Cam Chain | EC062020F | \$2.89 | 12837-31310 | | |
| | | Transmission Cover | EC063020F | \$2.61 | 24762-45000-H17 | | |
| | | Ignition Cover | EC338020F | \$3.64 | 11491-45000 | | |
| GS1100/1150 | 82-84 | 24 Bolt Valve Cover | C8264 | \$19.87 | | | |
| | | 20 Bolt Valve Cover | C8212 | \$19.87 | | | |
| GSX 1300R Hayabusa | 99-14 | Engine Case Rebuild | C8587AFM | \$72.97 | | | |
| | | Oil Pan | EC369060AFM | \$16.64 | 11489-24F01 | | |
| | | Clutch Cover | EC370060AFM | \$15.85 | 11482-24F01 | | |
| | | Starter Idle Gear Cover | EC371032AFM | \$6.64 | 11492-24F00 | | |
| | | Gear Shift Cover | EC372032AFM | \$6.64 | 11485-24F00 | | |
| | | Breather Cover | EC373032AFM | \$4.65 | 11318-24F00 | | |
| | | Magneto Cover | EC374060AFM | \$11.36 | 11483-24F00 | | |
| | | Starter Cover | EC375032AFM | \$7.95 | 11491-24F01 | | |
| | | Cam Chain | EC377032AFM | \$3.35 | 12837-24A10 | | |
| | | Exhaust Gaskets-4 PACK | C8745 | \$27.30 | 14181-22D01 | | |
| | | Cam Chain Tensioner (08-13) | EC1247018AFM | \$1.96 | 12837-02H00 | | |
| | | Valve Stem Seal Kit (99-13) | C8836 | \$70.40 | 09289-05011 | | |
| | | GSX-R1000 | 09-15 | Engine Case Rebuild Kit | C8893AFM | \$33.75 | |
| | | | | Cam Chain Tensioner Gasket | EC1247018AFM | \$2.04 | 12837-02H00 |
| | | | | Oil Pan Gasket | OP517060AFM | \$14.54 | 11489-47H00 |
| Clutch Cover Gasket | EC1579060AFM | | | \$14.25 | 11482-47H00 | | |
| Mag Cover Gasket | EC1410032AFM | | | \$11.36 | 11483-47H00 | | |
| GSX-R1000 | 03-08 | Engine Case Rebuild Kit | C8752AFM | \$53.80 | | | |
| | | Mag Cover Gasket | EC946032AFM | \$8.29 | 11483-18G00 | | |
| | | Starter Idle Gear Cover | EC521032AFM | \$7.95 | 11491-33E02 | | |
| | | Starter Clutch Cover | EC520032AFM | \$6.58 | 11492-33E00 | | |
| | | Breather Cover | EC522032AFM | \$4.65 | 11484-35F00 | | |
| | | Cam Chain Tensioner Gasket | EC945032AFM | \$3.52 | 12837-18G00 | | |
| | | Clutch Cover Gasket | EC947032AFM | \$14.25 | 11482-40F00 | | |
| | | Oil Pan Gasket | OP269060AFM | \$14.54 | 11489-21H00 | | |
| | | GSX-R1000 | 01-02 | Engine Case Rebuild Kit | C8206 | \$54.82 | |
| Mag Cover Gasket | EC519032AFM | | | \$10.15 | 11483-35F00 | | |
| Starter Idle Gear Cover | EC521032AFM | | | \$7.95 | 11491-33E02 | | |
| Starter Clutch Cover | EC520032AFM | | | \$6.58 | 11492-33E00 | | |
| Breather Cover | EC522032AFM | | | \$4.65 | 11484-35F00 | | |
| Cam Chain Tensioner Gasket | EC523032AFM | | | \$3.07 | 12837-35F00 | | |
| Clutch Cover Gasket | EC947032AFM | | | \$14.25 | 11482-40F00 | | |
| Oil Pan Gasket | OP071060AFM | | | \$14.59 | 11489-35F00 | | |

TRIUMPH

| Model | Year | Type | Bore Size | Displacement / cc | Material | Part # | Price | OEM Part # |
|----------------------|-------|-------------|-----------|-------------------|-----------------|--------|---------|------------|
| Bonneville, T100, | 02-15 | Head Gasket | 90mm | 865cc | MLS/C.O.T. .030 | C8850 | \$77.46 | T1152915 |
| Scrambler, Thruxton, | | Head Gasket | 92mm | 904cc | MLS/C.O.T. .030 | C8851 | \$77.46 | |
| America, Speedmaster | | Head Gasket | 96.5mm | 995cc | MLS/C.O.T. .030 | C8852 | \$77.46 | |
| | | Base Gasket | | 865cc-904cc | .020 RC Steel | C8853 | \$25.83 | T1160127 |
| | | Base Gasket | | 955cc | .020 RC Steel | C8854 | \$25.83 | |



STREET·ROAD RACE·STRIP



Cometic Gasket - An Exclusive NASCAR Performance® Product

YAMAHA

| Model | Year | Type | Bore Size | Displacement / cc | Material | Part # | Price | OEM Part # |
|--|-------|---|---|---|---|---|---|---|
| RD350 | 73-75 | Head/Base/Reed | 66 mm | 347cc -370cc | Copper .043 | C8331 | \$46.38 | 278-11181-01-00/ 278-11351-01-00/ 87A-13621-00-00 |
| RZ350 | 84-90 | Head/Base/Reed | 66 mm | 370cc | Spring Steel | C8334 | \$46.38 | 31K-11181-00-00/ 29L-11351-00-00/ 31K-13621-00-00 |
| FZR400 | 89-90 | Head Gasket Base Gasket | 58mm | 400cc 400cc | .010 Spring Steel Copper .020 | C8443 C8427 | \$83.52 \$33.68 | 1WG-11181-00-00 3TJ-11351-00-00 |
| TX, XS 650 | 74-82 | Head Gasket | 80.50 mm | 744cc - 752cc | CFM-20 .043 | C8043 | \$54.34 | 306-11181-09-00 |
| XS750 | 77-79 | Head Gasket | 70.0 mm | 747cc - 792cc | CFM-20 .043 | C8404 | \$54.34 | 2F3-11181-00-00 |
| FZR600 | 89-99 | Head Gasket Base Gasket | 60.5 mm 2.565 | 600cc - 629cc 600cc-618cc | .010 Spring Steel .020 Copper | C8282 C8427 | \$83.52 \$33.68 | 3HE-11181-00-00 3TJ-11351-00-00 |
| YZF600R | 95-07 | Head Gasket Base Gasket | 63 mm 65 mm | 599cc-618cc 618cc | .010 Spring Steel Copper .020 | C8424 C8427 | \$87.73 \$33.68 | 4JH-11181-00-00 3TJ-11351-00-00 |
| YZF-R6 | 99-02 | Head Gasket | 68.0 mm | 599cc-646cc | MLS/C.O.T. .030 MLS/C.O.T. .018 | C8575 C8575-018 | \$83.52 \$100.22 | 5EB-11181-00-00 5EB-11181-00-00 |
| YZF-R6 | 03-05 | | 68 mm 70.0 mm | 600cc-646cc 647cc-685cc | MLS/C.O.T. .027 MLS/C.O.T. .018 MLS/C.O.T. .027 | C8684 C8684-018 C8699 | \$87.73 \$100.22 \$87.73 | 5SL-11181-00-00 5SL-11181-00-00 5SL-11181-00-00 |
| YZF-R6 | 06-15 | Head Gasket | 68 mm 70 mm | 600cc-617cc 618cc-654cc | MLS/C.O.T. .018 MLS/C.O.T. .027 MLS/C.O.T. .018 MLS/C.O.T. .027 | C8699-018 C8710 C8710-018 C8712 | \$100.22 \$87.73 \$100.22 \$87.73 | 2C0-11181-00-00 2C0-11181-00-00 2C0-11181-00-00 2C0-11181-00-00 |
| FZ-07 | 15 | Head Gasket Head Gasket | 81mm 83mm | | MLS/C.O.T. .023 .MLS/C.O.T. .023 | C8890 C8891 | \$37.68 \$37.68 | 1WS-11181-00-00 1WS-11181-00-00 |
| TX, XS650 | 74-82 | Head Gasket Head Gasket Head Gasket Head Gasket Head Gasket | 75mm 77mm 79mm 81mm 82mm | | MLS/C.O.T. .045 MLS/C.O.T. .045 MLS/C.O.T. .045 MLS/C.O.T. .045 MLS/C.O.T. .045 | C8810 C8811 C8812 C8813 C8814 | \$57.20 \$57.20 \$57.20 \$57.20 \$57.20 | 306-11181-00-00 306-11181-00-00 306-11181-00-00 306-11181-00-00 306-11181-00-00 |
| FZR1000 | 89-95 | Head Gasket | 76.5 mm 78 mm 77 mm | 1003cc - 1029cc 1070cc 1040cc | MLS/C.O.T. .030 MLS/C.O.T. .030 MLS/C.O.T. .030 | C8384 C8388 C8283 | \$83.52 \$87.73 \$87.73 | 4SV-11181-00-00 4SV-11181-00-00 4SV-11181-00-00 |
| | | Base Gasket | 3.260 | 1070cc | Spring Steel .010 | C8382 | \$30.72 | 4SV-11181-00-00 |
| YFZ1000 | 97 | Head Gasket | 76.5 mm 77 mm 78 mm | 1003cc - 1029cc 1040cc 1070cc | MLS/C.O.T. .030 MLS/C.O.T. .030 MLS/C.O.T. .030 | C8384 C8283 C8388 | \$83.52 \$87.73 \$87.73 | 3GM-11181-00-00 3GM-11181-00-00 3GM-11181-00-00 |
| | | Base Gasket | 3.260 | 1070cc | .010 Spring Steel | C8382 | \$30.72 | 3GM-11351-00-00 |
| YZF-R1 | 98-03 | Head Gasket | 75 mm 77 mm | 1000cc 1054cc | MLS/C.O.T. .027 MLS/C.O.T. .027 | C8562 C8563 | \$83.52 \$87.73 | 4XV-11181-00-00 4XV-11181-00-00 |
| YZF-R1 | 04-06 | Head Gasket | 78 mm 79 mm | 998cc-1024cc 1025cc-1051cc | MLS/C.O.T. .018 MLS/C.O.T. .018 | C8686 C8695 | \$83.52 \$83.52 | 5VY-11181-00-00 5VY-11181-00-00 |
| YZF-R1 | 07-08 | Head Gasket | 78mm 79mm | 998cc-1024cc 998cc-1024cc | MLS/C.O.T. .018 MLS/C.O.T. .018 | C8266 C8767 | \$83.52 \$83.52 | 4C8-11181-00-00 4C8-11181-00-00 |
| | | Base Gasket (04-08) | | | .010" Spring Steel | C8687 | \$30.72 | 5VY-11351-00-00 |
| YZF-R1 | 09-14 | Head Gasket Base Gasket | 79mm | | MLS/C.O.T. .018" .010" Spring Steel | C8794 C8796 | \$83.52 \$24.22 | 14B-11181-00-00 14B-11351-00-00 |
| YZF-R1 | 15 | Head Gasket Base Gasket | 79 mm | | MLS/C.O.T. .027 .010" Spring Steel | C8894 C8895 | \$83.52 \$83.52 | 2CR-11181-00-00 2CR-11351-00-00 |
| XS1100 | | Head Gasket | 76 mm | 1148cc-1179cc | CFM-20 .043 | C8046 | \$54.34 | 2H7-11181-02-00 |
| FJ1100, 1200 | | Head Gasket | 77 mm 78 mm 79 mm 81 mm 83 mm | 1157cc - 1188cc 1219cc 1250cc 1314cc 1380cc | MLS/C.O.T. .030 MLS/C.O.T. .030 MLS/C.O.T. .030 MLS/C.O.T. .030 MLS/C.O.T. .030 | C8327 C8351 C8330 C8328 C8329 | \$83.52 \$87.73 \$83.52 \$87.73 \$87.73 | 1TX-11181-00-00 1TX-11181-00-00 1TX-11181-00-00 1TX-11181-00-00 1TX-11181-00-00 |
| | | Base Gasket | 3.285 | 1157cc - 1260cc | .010 Spring Steel Copper .005 Copper .010 Copper .020 | C8597 C8139 C8140 C8141 | \$29.24 \$33.68 \$35.38 \$35.38 | 4CR-11351-00-00 4CR-11351-00-00 4CR-11351-00-00 4CR-11351-00-00 |
| | | Base Gasket | 3.460 | 1314cc | .010 Spring Steel Copper .005 Copper .010 Copper .020 Fiber .020 | C8598 C8240 C8241 C8242 C8239 | \$30.72 \$33.68 \$35.38 \$35.38 \$13.79 | 4CR-11351-00-00 4CR-11351-00-00 4CR-11351-00-00 4CR-11351-00-00 4CR-11351-00-00 |
| FJ1100, 1200 Legend Approved | | Head Gasket | 77.5 mm 79.0 mm | 1195cc - 1202cc 1250cc | MLS/C.O.T. .030 Copper .032 | C8285 C8174 | \$83.52 \$65.64 | 1TX-11181-00-00 1TX-11181-00-00 |
| | | Base Gasket | 3.285 | 1157cc - 1260cc | Fiber .020 | C8142 | \$13.79 | |
| VMX12 V-Max / XVZ13 Royal Star | 83-07 | Head Gasket | 80.0mm 85.0 mm | 1198cc - 1327cc 1394cc - 1498cc | MLS/C.O.T. .030 MLS/C.O.T. .030 | C8536 C8535 | \$87.73 \$87.73 | 26H-11181-00-00 26H-11181-00-00 |
| XV1600 Road Star/ Midnight Star | 99-03 | Head Gaskets (2) | 95 mm 97 mm 100 mm 102 mm | | MLS/C.O.T. .030 MLS/C.O.T. .030 MLS/C.O.T. .030 MLS/C.O.T. .030 | C8673 C8674 C8675 C8676 | \$59.52 \$59.52 \$59.52 \$59.52 | 4WM-11181-00-00 4WM-11181-00-00 4WM-11181-00-00 4WM-11181-00-00 |
| XV1700 Road Star Warrior | 02-07 | Head Gaskets (2) | 97 mm | | MLS/C.O.T. .030 | C8677 | \$59.52 | 5PX-11181-01-00 |
| XV1700 Road Star | 04-07 | | 100 mm 102 mm | | MLS/C.O.T. .030 MLS/C.O.T. .030 | C8678 C8679 | \$59.52 \$59.52 | 5PX-11181-01-00 |
| XV1900 Raider, Roadliner, Stratoliner | 06-14 | Head Gaskets (2) Head Gaskets (2) | 102 mm 103 mm | | MLS/C.O.T. .030" MLS/C.O.T. .030" | C8857 C8858 | \$43.54 \$43.54 | 1D7-11181-00-00 |

All Component Parts can be purchased individually.



Yamaha Engine Case Rebuild

| Model | Year | Part Description | Part # | Retail | OEM Part # |
|---------------------------------|-------|----------------------------|--------------|---------|-----------------|
| YZF-R6 | 06-15 | Engine Case Rebuild | C8720 | \$29.24 | |
| | | Cam Chain Tensioner | EC1152032AFM | \$2.33 | 2C0-12213-00-00 |
| | | Case Breather | EC1149032AFM | \$10.68 | 2C0-15462-00-00 |
| | | Clutch Cover | EC1151032AFM | \$16.64 | 2C0-15461-00-00 |
| | | Ignition Cover | EC1104018AFM | \$12.99 | 2C0-15451-00-00 |
| | | Oil Pan | OP201032AFM | \$19.25 | 2C0-13414-01-00 |
| | | Oil Pump Cover | EC1105032AFM | \$10.68 | 2C0-15456-00-00 |
| YZF-R6 | 03-05 | Engine Case Rebuild | C8683 | \$29.24 | |
| | | Clutch Cover | EC939032AFM | \$10.68 | 5SL-15461-00 |
| | | Ignition Cover | EC355032AFM | \$5.28 | 5EB-15456-00-00 |
| | | Case Breather Cover | EC937032AFM | \$3.87 | 5SL-15462-00 |
| | | Magneto Cover | EC938032AFM | \$4.72 | 5SL-15451-00-11 |
| YZF-R6 | 99-02 | Engine Case Rebuild | C8612AFM | \$19.87 | |
| | | Gear Selector Cover | EC354032AFM | \$7.95 | 5SL-11181-00-00 |
| | | Ignition Cover | EC355032AFM | \$5.28 | 5EB-15456-00-00 |
| | | Clutch Cover | EC356032AFM | \$5.28 | 5EB-15461-00-00 |
| | | Magneto Cover | EC421020F | \$5.51 | 5EB-15451-00-00 |
| | | Oil Pan Gasket | OP246032AFM | \$18.51 | 5EB-13414-00-00 |
| FZR600 | 89-99 | Engine Case Rebuild | C8402 | \$19.87 | |
| | | Clutch Cover | EC086020F | \$4.94 | 3HE-15462-10-00 |
| | | Generator Cover | EC087020F | \$5.17 | 1WG-15455-10-00 |
| | | Starter Clutch Cover | EC088020F | \$5.17 | 3HE-14461-10-00 |
| | | Oil Pan | EC089020F | \$5.91 | 3HE-13414-10-00 |
| YZF600R | 95-07 | Engine Case Rebuild | C8402 | \$19.87 | |
| | | Clutch Cover | EC086020F | \$4.94 | 3HE-15462-10 |
| | | Generator Cover | EC087020F | \$5.17 | 1WG-15455-10 |
| | | Starter Clutch Cover | EC088020F | \$5.27 | 3HE-14461-10 |
| | | Oil Pan | EC089020F | \$5.91 | 3HE-13414-10-00 |
| FZ-07 | 15 | Engine Case Rebuild Kit | C8892 | \$32.08 | |
| | | Oil Pump Cover Gasket | EC2053018AFM | \$2.04 | 1WS-15456-00 |
| | | Oil Pan Gasket | OP516032AFM | \$10.52 | 1WS-13414-00-00 |
| | | Mag Cover Gasket | EC2025032AFM | \$9.42 | 1WS-15451-00-00 |
| | | Clutch Cover Gasket | EC2024032AFM | \$14.26 | 1WS-15461-00-00 |
| | | Cam Chain Tensioner Gasket | EC2027018AFM | \$2.04 | 1WS-12213-00-00 |
| | | Breather Plate Gasket | EC2026018AFM | \$3.86 | 1WS-11169-00-00 |
| FZR1000 | 89-95 | Engine Case Rebuild | C8088 | \$17.26 | |
| | | Oil Pan | EC015020F | \$8.86 | 4FM-13414-00-00 |
| | | Clutch Cover | EC016020F | \$4.94 | 4FM-15461-00-00 |
| YZF-R1 | 98-03 | Engine Case Rebuild | C8588 | \$29.19 | |
| | | Cam Chain | EC019032AFM | \$2.04 | 4FM-12213-00 |
| | | Clutch Cover | EC383032AFM | \$7.38 | 4XV-15461-00-00 |
| | | Gear Selector Cover | EC384032AFM | \$3.07 | 4XV-15463-00-00 |
| | | Ignition Cover | EC385018AFM | \$3.97 | 4XV-15456-00-00 |
| | | Oil Strainer Cover | EC387018AFM | \$8.69 | 4XV-13414-00-00 |
| | | Oil Pump Cover | EC940032AFM | \$3.97 | 5JJ--15456-00 |
| YZF-R1 | 04-08 | Engine Case Rebuild | C8688 | \$26.74 | |
| | | Oil Pump Cover | EC941032AFM | \$5.11 | 5VY-15456-00 |
| | | Breather Cover | EC942032AFM | \$7.10 | 5VY-15462-00 |
| | | Ignition Cover | EC943032AFM | \$5.11 | 5VY-15451-00 |
| | | Clutch Cover | EC944032AFM | \$9.47 | 5VY-15461-00 |
| | | Oil Pan (04-06) | OP205032AFM | \$19.25 | 5VY-13414-01 |
| | | Oil Pan (10-14) | OP361032AFM | \$19.25 | 14B-13414-00-00 |
| YZF-R1 | 15 | Engine Case Rebuild Kit | C8896 | \$28.05 | |
| | | Clutch Cover Gasket | EC2067032AFM | \$14.99 | 2CR-15461-00-00 |
| | | Mag Cover Gasket | EC2068032AFM | \$5.11 | 2CR-15451-00-00 |
| | | Breather Cover Gasket | EC2069018AFM | \$7.10 | 2CR-15462-00-00 |
| | | Oil Pan Gasket | OP519032AFM | \$3.97 | 2CR-15456-00-00 |
| FJ1100, 1200 Legend Approved | | Engine Case Rebuild | C8146 | \$20.90 | |
| | | Oil Pan | EC017032AFM | \$8.86 | 4CR-13414-00-00 |
| | | Clutch Cover(FJ1200) | EC018018AFM | \$4.94 | 4FM-13414-00-00 |
| | | Cam Chain | EC019018AFM | \$2.04 | 4FM-12213-00-00 |
| | | Oil Strainer Cover | EC020032AFM | \$2.04 | 4CR-13415-00-00 |
| | | Clutch Cover(FJ1100) | EC039032AFM | \$4.94 | 36Y-15461-00-00 |



| Model | Displ. cc | Bore mm | Top End Kit Part # | Price |
|---|-----------|---------|--------------------|----------|
| ARCTCO | | | | |
| Barracuda, Daytona 94-95, Montego, Montego Deluxe 94-97, TT640R 98-99, TS640L 98, Tigershark, Tigershark Daytona 33 | 639 | 77mm | C6052 | \$44.97 |
| Monte Carlo, Daytona 96-97, TS770, TS-L770, TS-R 98-99 | 770 | 84mm | C6144 | \$60.81 |
| Tigershark 900 95, Monte Carlo 900 96, Daytona 1000 97 | 900 | O-Ring | C6116 | \$72.97 |
| TS-11000, TS-R1000 98 | 999 | O-Ring | C6162 | \$72.97 |
| KAWASAKI | | | | |
| JS300, JS300SX 86-94 | 300 | 78mm | C6001 | \$21.86 |
| JS440, JSX440, JSX440SX 82-92 | 440 | 70mm | C6002 | \$39.99 |
| JS440, JSX440, JSX440SX 82-92 | 475 | 73mm | C6003 | \$39.99 |
| JS550 thru 82-88 | 550 | 77mm | C6004 | \$59.57 |
| JS550, JSX550 89-95 | 550 | 78mm | C6015 | \$59.57 |
| JS650SC 91-95, JF650X2 86-95, JF650TS 89-96 | 650 | 78mm | C6005 | \$42.54 |
| JS650SX 87-93, JS650SC 91-95, JF650X2 86-95 | 701 | 80mm | C6078 | \$42.54 |
| JS750SX 92-95, JS750Sxi 95-97, JH750Xi 93-97, JH750SS 92-97, JH750XiR 94 | 750 | 83mm | C6043 | \$42.54 |
| JT750STS 95-97, JT750ST 94-95, 750ZXi 95-97, 750SXi 98-02 | | | | |
| 750Xi 95-97, SXI Pro 98-02, STX 98 | 766 | 81mm | C6215 | \$42.54 |
| 750ZXi 95-97, SXI Pro 98-02, STX 98, SX800R 03-06 | 779 | 83mm | C6126 | \$42.54 |
| 750ZXi 95-97, SXI Pro 98-02, STX 98, SX800R 03-06 | 830 | 84.5mm | C6158 | \$42.54 |
| 800 SXR 03-11 | 779 | 82mm | C6214 | \$58.99 |
| 900ZXi 95-97, STX 97-06 | 941 | 75mm | C6118 | \$60.81 |
| 1100ZXi 96-03, 1100STX 97-99, STX D. I. 00-03 | 1097 | 81mm | C6145 | \$72.97 |
| 1100Zxi 96-03, 1100STX 97-99, STX D. I. 00-03 | 1195 | 84.5mm | C6159 | \$85.12 |
| Ultra 150 99-05, 1200STX '02-05 | 1205 | 81mm | C6202 | \$85.12 |
| Ultra 250/260X 07-10 (Head Gasket Only) | 1498 | 84mm | C6222 | \$103.17 |
| POLARIS | | | | |
| SL650 92-95, SL650STD 92-95 | 650 | 67mm | C6044 | \$60.81 |
| SLTH 96-03, SLT 700 96-03, SL700DLX 96-03, SLH 96-03, SL700 96-03 | 700 | O-Ring | C6146 | \$72.97 |
| SL750 92-96, SLT 92-96 | 750 | 71.25mm | C6055 | \$72.97 |
| SL750 92-96, SLT 92-96 | 782 | 72mm | C6089 | \$72.97 |
| SLX780 95-97, SL780 95-96, SLT780 95-96 | 780 | 71.5mm | C6143 | \$60.81 |
| SLX 785 Pro 97-01 | 785 | 72mm | C6181 | \$60.81 |
| SL900 96-97 | 900 | O-Ring | C6147 | \$60.81 |
| SLTX1050 97-04, SL1050 96-04, SLXH 98-04 | 1051 | O-Ring | C6148 | \$60.81 |
| Genesis Ffi 00-04, Pro 1200 00-04, SLX, Virage TX 00-04 | 1176 | 86mm | C6212 | \$97.27 |
| SEA DOO | | | | |
| 580 Yellow Motor 91, 580XP 91, 580GT 90-91 | 580 | O-Ring | C6010 | \$60.81 |
| 580 White Motor, 580 SP, XP, SPX, Spi, GTS, GTX 92-96 | 580 | O-Ring | C6095 | \$60.81 |
| 650XP 93-94, 650XPI 94-95, 650SPX 94-95, GTX650 94-95 | 657 | O-Ring | C6056 | \$60.81 |
| GTI750, SPX750, XP750, HX750, GS750, GTS 750 97-01 | 717 | O-Ring | C6119 | \$60.81 |
| XP 800, GSX800, GTX800, SPX800, XP800 Ready, RFI800, 97-01 (Lay Down Motor) | 787 | O-Ring | C6154 | \$60.81 |
| GSX950 Limited 97-99, GTX950 Limited 98-00 | 993 | 90mm | C6157 | \$97.27 |
| XP950 Limited 98-00, GTX950 00, RX950 00, LRV950 00 | | | | |
| GSX950 Limited 97-99, GTX950 Limited 98-00 | 1017 | 90mm | C6203 | \$97.27 |
| XP950 Limited 98-00, GTX950 00, RX950 00, LRV950 00 | | | | |
| 4TEC 02-14 (Head Gasket Only) | 1494 | 101mm | C6223 | \$103.17 |
| SUZUKI | | | | |
| Wet Bike 78-92 | | 86mm | C6163 | \$39.99 |
| YAMAHA | | | | |
| Waverunner III 90-93, VXR 91-95, Waverunner 90-93, Super Jet ALL, LX633 90-96 | 633 | 79mm | C6012 | \$43.77 |
| Waveblaster 93-95, Super Jet 94-95, Waverunner III 94-97, Pro-VXR 93-94, FX700 94-95, Waveraider 700 96-99 (Kit works with all single carb models) | 701 | 83mm | C6057 | \$43.77 |
| Waveblaster 93-95, Super Jet 94-95, Waverunner III 94-97, Pro-VXR 93-94, FX700 94-95, Waveraider 700 96-99 (Kit works with all single carb models) | 760 | 85mm | C6083 | \$47.41 |
| Waveblaster 96-97, Super Jet 97-00, Wave Venture 700 95-97, Waveraider 700 93-95, Waveraider Deluxe 93-95, XL700 thru 99-00 (Kit works with all dual carb models) | 701 | 83mm | C6084 | \$47.41 |
| Waveblaster 96-97, Super Jet 97-00, Wave Venture 700 95-97, Waveraider 700 93-95, Waveraider Deluxe 93-95, XL700 thru 99-00 (Kit works with all dual carb models) | 760 | 85mm | C6086 | \$47.41 |
| Waveraider 760 96-99, Waveblaster II 96-99, Wave Venture 760 97, Waverunner 96-97, Waverunner GP 760 '00 | 754 | 85mm | C6149 | \$47.41 |
| Waveraider 760 96-99, Waveblaster II 96-99, Wave Venture 760 97, Waverunner 96-97 | 789 | 86mm | C6155 | \$47.41 |
| 800 GP 98-00 | 800 | 86mm | C6199 | \$47.41 |
| Waveraider 1100 95-97, Wave Venture 1100 96-97 | 1051 | 83mm | C6121 | \$97.27 |
| 1200 GP 97-99, SUV1200 00, XI 1200 00 | 1131 | 86mm | C6160 | \$97.27 |
| GP1200R 01-10 (with power valve) | 1176 | 82mm | C6220 | \$142.52 |
| FZR Waverunner 08-14 (Head Gasket Only) | 1812 | 86mm | C6221 | \$103.17 |



Gaskets for Harley-Davidson®

AFM® Series Gaskets Aluminum Foamet Composite Material

Cometic Part #-C9888 Complete Primary Kit FLT, FLHT, FXR 94-06
Cometic Part #-C9889 Complete Primary Kit FLT, FLHT, FXR 80-93

Cometic Part #-C9261
Starter Shaft Seal 94-06
Dyna 94-05
All B/T Models
Replaces: 12066
Cometic Part #-C9379
Starter Shaft Seal 89-93
All B/T Models
Replaces: 12053

Cometic Part #-C9441
Inner Primary to Motor
Case O-Ring
Dyna L82-05
All Models L82-06
Replaces: 11147
Cometic Part #-C9536
Inner Primary to Motor
Case O-Ring
All Models 70-E82
Replaces: 11125

Cometic Part #-C9261
Starter Shaft Seal
Dyna 94-05, All B/T
Models 94-06 Replaces: 12066
Cometic Part #-C9379
Starter Shaft Seal 89-93 All B/T Models
Replaces: 12053

Cometic Part #-C9260
Wet Clutch Oil Seal All Models L84-UP
Replaces: 12052
Cometic Part #-C9518
Wet Clutch Oil Seal All Models 70-E84
Replaces: 12052

Cometic Part #-C9441
Inner Primary to
Motor Case O-Ring
All Models L82-06,
Dyna L82-05
Replaces: 11147
Cometic Part #-C9536
Inner Primary to
Motor Case O-Ring All
Models 70-E82
Replaces: 11125

Cometic Part #-C9942F1
Primary Spacer Gasket "Pair"
Softail 95-06

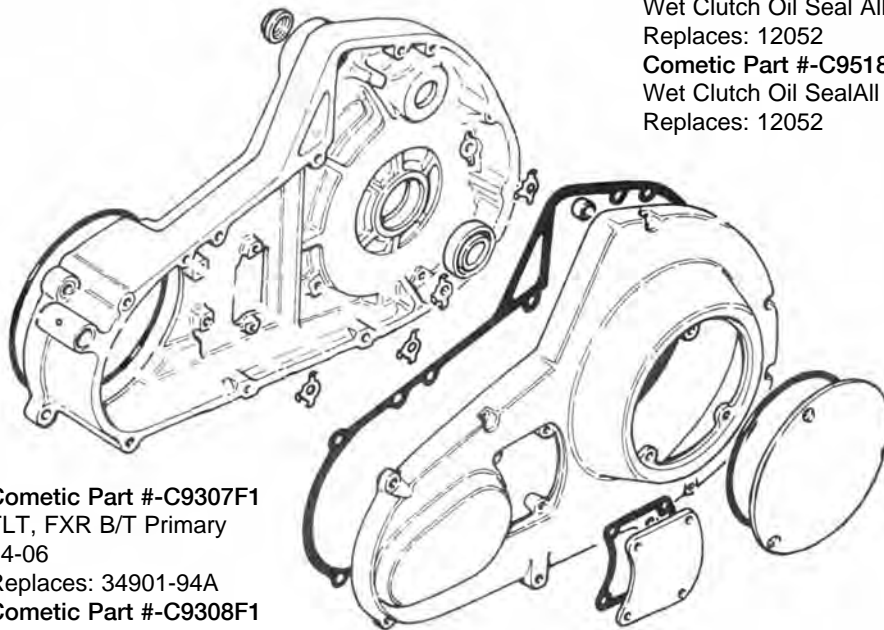

Cometic Part #-C9307F1
FLT, FXR B/T Primary
94-06
Replaces: 34901-94A
Cometic Part #-C9308F1
FLT, FXR B/T Primary
80-93
Replaces: 34901-79A

Cometic Part #-C9305F1
FLT, FXR Inspection Cover 85-06
Replaces: 34906-85A
Cometic Part #-C9303F1
FLT, FXR Inspection Cover 80-84
Replaces: 34906-79A

Cometic Part #-C9260
Wet Clutch Oil Seal All Models L84-UP
Replaces: 12052
Cometic Part #-C9518
Wet Clutch Oil Seal All Models 70-E84
Replaces: 12052

Cometic Part #-C9662
Derby Cover O-Ring
All Big Twin Models
99-06, Dyna 99-05
Replaces: 25416-99

Cometic Part #-C9442
Derby Cover O-Ring
All Big Twin Models
L84-98
Replaces: 25416-84
Cometic Part #-C9997F1
Derby Cover Gasket
Replaces O-Ring
All Big Twin Models
99-UP 5 Hole
Replaces: 25416-99C

Cometic Part #-C9309F1
Primary Gasket Softail 89-06, Dyna 89-05
Replaces: 60539-89
Cometic Part #-C9607F1
Primary Gasket Softail, Superglide 65-88
All Four Speeds
Replaces: 60538-81C
Cometic Part #-C9885
94-06 FXST, 94-05 FXD Primary Kit
Cometic Part #-C9886
89-93 FXST, FXD Primary Kit
Cometic Part #-C9887
65-88 FXST, FX, FL 4-Speed Primary Kit

Cometic Part #-C9338F1
Derby Cover Gasket
All 4 Speed Models 70-83
Replaces: 25416-70
Cometic Part #-C9662
Derby Cover O-Ring
All Big Twin Models
99-06, Dyna 99-05
Replaces: 25416-99
Cometic Part #-C9442
Derby Cover O-Ring
All Big Twin Models
L84-98
Replaces: 25416-84
Cometic Part #-C9997F1
Derby Cover Gasket
Replaces O-Ring
All Big Twin Models
99-UP 5 Hole
Replaces: 25416-99C

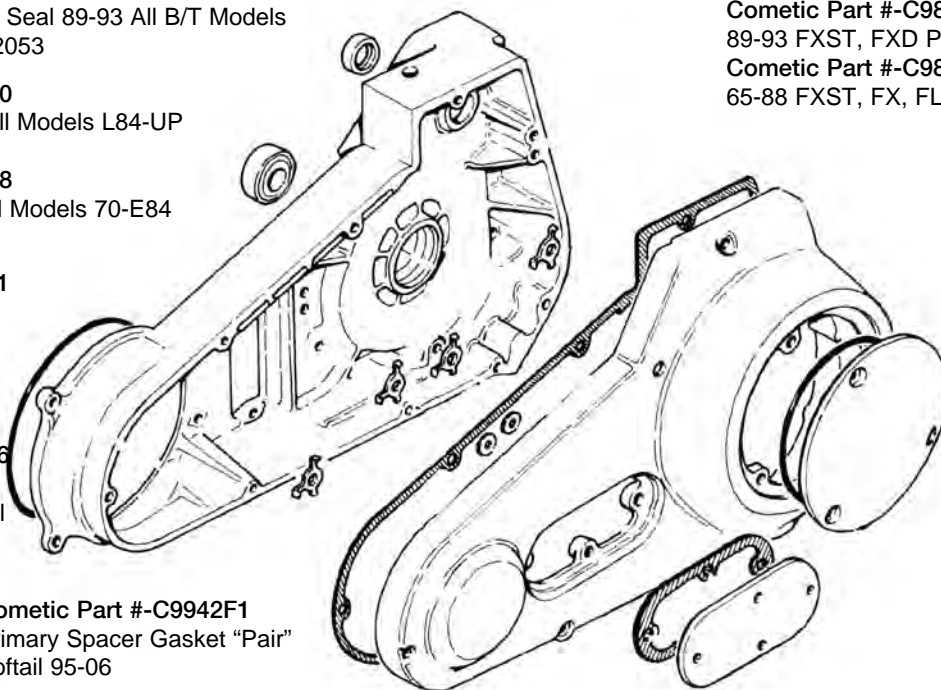

Cometic Part #-C9331F1 Inspection Cover Gasket
Dyna & Softail, 4 & 5 Speed Dyna 65-05 , Softail 65-06



Big Twin Primary Gasket & Seal Kits (All kits contain all Gaskets and Seals needed to R&R Inner & Outer Primary)

| Cometic Part # | Description | Price |
|----------------|--|----------|
| C9173 | 07-16 FL Models Primary Kit | \$90.99 |
| C9150 | 06-16 Dyna Primary Kit, 07-UP Softail | \$90.99 |
| C9885 | 94-06 FXST, 94-05 FXD Primary Kit | \$102.11 |
| C9888 | 94-06 FLT, FLHT, FXR Primary Kit | \$96.99 |
| C9886 | 89-93 FXST, FXD Primary Kit | \$102.61 |
| C9889 | 80-93 FLT, FLHT, FXR Primary Kit | \$74.28 |
| C9887 | 65-88 FXST, FX, FL 4-Speed Primary Kit | \$74.28 |

Primary Gaskets Big Twin, Twin Cam

| Cometic Part # | OE# | Description | Single Price | 5 Pack Price |
|----------------|---------------|---|--------------|--------------|
| Single | 5 Pack | | | |
| C9179F1 | C9179F5 | 34901-07 07-16 FL Models Primary | \$33.73 | \$151.73 |
| C9145F1 | C9145F5 | 60547-06 06-16 Dyna, 07-UP Softail | \$33.73 | \$151.73 |
| C10122 | | 2007-UP Primary Push Pin 10 Pk. | | \$11.60 |
| C9199F1 | C9199F5 | 34934-06 06 Dyna, 07-16 All T/C Inner Primary spacer/seal | \$26.69 | \$133.44 |
| C9942F1 | C9942F5 | 63859-95A 95-06 Softail primary spacer gasket (Pair) | \$2.22 | \$9.77 |
| C9307F1 | C9307F5 | 34901-94A 94-06 FLT, FXR Big Twin Primary | \$33.73 | \$151.73 |
| C9308F1 | C9308F5 | 34901-79A 80-93 Big Twin Primary FLT/FXR | \$33.73 | \$151.73 |
| C9309F1 | C9309F5 | 60539-89 89-06 Softail, 89-05 Dyna | \$33.73 | \$151.73 |
| C9607F1 | C9607F5 | 60538-81C 65-88 FXST, FX / FL 4 -SPEED | \$33.73 | \$151.73 |
| C10125F1 | C10125F5 | 1970-06 Big Twin Case Saver Gasket | \$7.50 | \$37.50 |

Inspection Cover Gaskets Big Twin, Twin Cam

| Cometic Part # | OE# | Description | Single Price | 5 Pack Price |
|----------------|---------------|--|--------------|--------------|
| Single | 5 Pack | | | |
| C9305F1 | C9305F5 | 34906-85A 85-06 FXR, FLT Insp. Cover | \$8.06 | \$32.19 |
| C9303F1 | C9303F5 | 34906-79A 80-84 FXR, FLT Insp. Cover | \$7.56 | \$32.19 |
| C9326F1 | C9326F5 | 60567-36 36-58-64-69 FL, XLCH Inspection Cover | \$3.97 | \$20.55 |
| C9331F1 | C9331F5 | 60567-65B 65-06 Softail 4&5 Speed, 89-05 Dyna Inspection Cover | \$5.28 | \$23.17 |

Derby Cover Gasket Big Twin

| Cometic Part # | OE# | Description | Single Price | 5 Pack Price |
|----------------|---------------|---|--------------|--------------|
| Single | 5 Pack | | | |
| C10140F1 | C10140F5 | 25416-16 2016- T/C All FL Models Except CVO & Low | \$6.14 | \$26.80 |
| C9997F1 | C9997F5 | 25416-99C 99-16 Derby Cover Replaces O-ring, 5 Hole | \$6.14 | \$26.80 |
| C9183F1 | C9183F5 | 84-98 All Derby Cover Replaces O-Ring, 3 Hole | \$6.14 | \$26.80 |
| C9152F1 | C9152F5 | 17369-06 06-16 Dyna, 07-16 All Twin Cam Models O-ring | \$6.14 | \$26.80 |
| C9338F1 | C9338F5 | 25416-70 70-83 FL, FXR Derby Cover | \$7.56 | \$37.94 |

Cam Cover Gaskets Big Twin, Twin Cam

| Cometic Part # | OE# | Description | Single Price | 5 Pack Price |
|----------------|---------------|------------------------------------|--------------|--------------|
| Single | 5 Pack | | | |
| C9575F1 | C9575F5 | 25244-99 99-16 Twin Cam, Cam Cover | \$10.45 | \$52.47 |
| C9328F1 | C9328F5 | 25225-93X 93-98 Big Twin Cam Cover | \$6.50 | \$32.21 |
| C9302F1 | C9302F5 | 25225-70X 70-92 Big Twin Cam Cover | \$6.50 | \$32.21 |
| C9334F1 | C9334F5 | 25225-36C 41-69 Big Twin Cam Cover | \$13.32 | \$53.29 |

Sportster Primary Gasket and Seal Kit

| Cometic Part # | Description | Price |
|----------------|--|---------|
| C9125 | 04-16 Sportster Complete Primary Rebuild | \$30.38 |
| C9211 | 91-03 Sportster Complete Primary Rebuild | \$40.88 |
| C9210 | 96-90 Sportster Complete Primary Rebuild | \$40.88 |

Sportster Primary Gasket

| Cometic Part # | OE# | Description | Single Price | 5 Pack Price |
|----------------|---------------|----------------------------------|--------------|--------------|
| Single | 5 Pack | | | |
| C9943F1 | C9943F5 | 34955-04 04-16 Sportster Primary | \$23.39 | \$105.16 |
| C9314F1 | C9314F5 | 34955-89A 91-03 Sporty Primary | \$23.39 | \$105.16 |
| C9310F1 | C9310F5 | 34955-75X 77-90 Sporty Primary | \$23.39 | \$105.16 |

Sportster Cam Cover Gasket

| Cometic Part # | OE# | Description | Single Price | 5 Pack Price |
|----------------|---------------|-------------------------------------|--------------|--------------|
| Single | 5 Pack | | | |
| C9944F1 | C9944F5 | 25263-90D 04-16 Sportster Cam Cover | \$7.56 | \$32.19 |
| C9313F1 | C9313F5 | 25263-90B 91-03 Sporty Cam Cover | \$12.16 | \$60.65 |
| C9311F1 | C9311F5 | 25263-86 86-90 Sporty Cam Cover | \$13.52 | \$67.40 |
| C10029F1 | C10029F5 | 25279-08 08-UP XR1200 Cam Cover | \$7.56 | \$32.19 |
| C9310F1 | C9310F5 | 34955-75X 77-90 Sporty Primary | \$23.39 | \$105.16 |

Street 500-750 Alternator Cover Gasket

| Cometic Part # | OE# | Description | Single Price | 5 Pack Price |
|----------------|---------------|---|--------------|--------------|
| Single | 5 Pack | | | |
| C10131F1 | C10131F5 | 25700224 2014-16 Street 500/750 Alternator Cvr Gasket | \$11.05 | \$49.72 |

Street 500-750 Primary Cover Gasket

| Cometic Part # | OE# | Description | Single Price | 5 Pack Price |
|----------------|---------------|--|--------------|--------------|
| Single | 5 Pack | | | |
| C10132F1 | C10132F5 | 25700210 2014-16 Street 500/750 Primary Cvr Gasket | \$18.95 | \$85.27 |



Gaskets for Harley-Davidson®

MLS® Multi-Layer Steel

Head & Base Gaskets

| Part # | Description | Price |
|--------|-------------|-------|
|--------|-------------|-------|

V - Rod MLS Head Gaskets (Pairs) 2001-16

| | | |
|-------|-------------------------------------|---------|
| C9895 | V-Rod .027" Std Bore Head Gasket | \$95.22 |
| C9896 | V-Rod .030" Std Bore Head Gasket | \$95.22 |
| C9897 | V-Rod .027" 4.250" Bore Head Gasket | \$95.22 |
| C9898 | V-Rod .030" 4.250" Bore Head Gasket | \$95.22 |

V - Rod EXTREME DUTY Exhaust Gaskets (Pair) 2001-16

| | | |
|--------|--|---------|
| C9928 | V-Rod Extreme Performance Exhaust Gasket | \$10.90 |
| C10060 | V-Rod OE Replacement Gasket Pair (Replaces 65109-01) | \$24.50 |

Twin Cam, Twin Cooled MLS Head Gaskets (Pairs) Select 2014 -16 Touring Models & Trikes

NOTE: TWIN COOLED H/G WILL RETRO TO AIR COOLED HEADS & CYLINDERS

| | | |
|------------|-------------------------------|---------|
| C10081 | 3.875", .027"MLS, Twin Cooled | \$44.99 |
| C10081-030 | 3.875", .030"MLS, Twin Cooled | \$44.99 |
| C10081-036 | 3.875", .036"MLS, Twin Cooled | \$44.99 |
| C10081-040 | 3.875", .040"MLS, Twin Cooled | \$44.99 |
| C10081-045 | 3.875", .045"MLS, Twin Cooled | \$44.99 |
| C10083 | 3.937", .027"MLS, Twin Cooled | \$44.99 |
| C10083-030 | 3.937", .030"MLS, Twin Cooled | \$44.99 |
| C10083-036 | 3.937", .036"MLS, Twin Cooled | \$44.99 |
| C10083-040 | 3.937", .040"MLS, Twin Cooled | \$44.99 |
| C10083-045 | 3.937", .045"MLS, Twin Cooled | \$44.99 |
| C10084 | 4.000", .027"MLS, Twin Cooled | \$44.99 |
| C10084-030 | 4.000", .030"MLS, Twin Cooled | \$44.99 |
| C10084-036 | 4.000", .036"MLS, Twin Cooled | \$44.99 |
| C10084-040 | 4.000", .040"MLS, Twin Cooled | \$44.99 |
| C10084-045 | 4.000", .045"MLS, Twin Cooled | \$44.99 |
| C10085 | 4.060", .027"MLS, Twin Cooled | \$44.99 |
| C10085-030 | 4.060", .030"MLS, Twin Cooled | \$44.99 |
| C10085-036 | 4.060", .036"MLS, Twin Cooled | \$44.99 |
| C10085-040 | 4.060", .040"MLS, Twin Cooled | \$44.99 |
| C10085-045 | 4.060", .045"MLS, Twin Cooled | \$44.99 |
| C10086 | 4.125", .027"MLS, Twin Cooled | \$44.99 |
| C10086-030 | 4.125", .030"MLS, Twin Cooled | \$44.99 |
| C10086-036 | 4.125", .036"MLS, Twin Cooled | \$44.99 |
| C10086-040 | 4.125", .040"MLS, Twin Cooled | \$44.99 |
| C10086-045 | 4.125", .045"MLS, Twin Cooled | \$44.99 |
| C10087 | 4.160", .027"MLS, Twin Cooled | \$44.99 |
| C10087-030 | 4.160", .030"MLS, Twin Cooled | \$44.99 |
| C10087-036 | 4.160", .036"MLS, Twin Cooled | \$44.99 |
| C10087-040 | 4.160", .040"MLS, Twin Cooled | \$44.99 |
| C10087-045 | 4.160", .045"MLS, Twin Cooled | \$44.99 |
| C10088 | 4.250", .027"MLS, Twin Cooled | \$44.99 |
| C10088-030 | 4.250", .030"MLS, Twin Cooled | \$44.99 |
| C10088-036 | 4.250", .036"MLS, Twin Cooled | \$44.99 |
| C10088-040 | 4.250", .040"MLS, Twin Cooled | \$44.99 |
| C10088-045 | 4.250", .045"MLS, Twin Cooled | \$44.99 |

Twin Cam MLS Head Gaskets (Pairs)

*2007 Twin Cams 96" displacement increase was made by increasing the stroke to 4.375" std. 96" and big bore 103" are the same bore size as 88" and 95" bores.

| | | |
|-----------|---|---------|
| C9790 | 3.750" Head Gasket .030" MLS All Twin Cam Models Std bore 1999-11 | \$44.99 |
| C9745 | 3.750" Head Gasket .040" MLS All Twin Cam Models Std bore 1999-11 | \$44.99 |
| C9181 | 3.750" Head Gasket .045" MLS All Twin Cam Models Std bore 1999-11 | \$44.99 |
| C9157 | 3.750" Head Gasket .051" MLS All Twin Cam Models Std bore 1999-11 | \$44.99 |
| C9158 | 3.750" Head Gasket .060" MLS All Twin Cam Models Std bore 1999-11 | \$66.83 |
| C9721 | 3.875" Head Gasket .030" MLS All Twin Cam Models 95" & 103" 1999-16 | \$44.99 |
| C9721-040 | 3.875" Head Gasket .040" MLS All Twin Cam Models 95" & 103" 1999-16 | \$44.99 |
| C9721-045 | 3.875" Head Gasket .045" MLS All Twin Cam Models 95" & 103" 1999-16 | \$44.99 |
| C9721-051 | 3.875" Head Gasket .051" MLS All Twin Cam Models 95" & 103" 1999-16 | \$44.99 |
| C9721-060 | 3.875" Head Gasket .060" MLS All Twin Cam Models 95" & 103" 1999-16 | \$66.83 |



Gaskets for Harley-Davidson®

MLS® Multi-Layer Steel

Head & Base Gaskets

| Part # | Description | Price |
|--|--|---------|
| Twin Cam MLS Head Gaskets (Pairs) con't. | | |
| *2007 Twin Cams 96" displacement increase was made by increasing the stroke to 4.375" std. 96 and big bore 103" are the same bore size as 88" and 95" bores. | | |
| C9894 | 3.937" Head Gasket .030" MLS All Twin Cam Models 97" & 107" 1999-16 | \$44.99 |
| C9894-040 | 3.937" Head Gasket .040" MLS All Twin Cam Models 97" & 107" 1999-16 | \$44.99 |
| C9894-051 | 3.937" Head Gasket .051" MLS All Twin Cam Models 97" & 107" 1999-16 | \$44.99 |
| C9725 | 4.000" Head Gasket .030" MLS All Twin Cam Models 100" & 110" 1999-16 | \$44.99 |
| C9726 | 4.000" Head Gasket .040" MLS All Twin Cam Models 100" & 110" 1999-16 | \$44.99 |
| C9070-030 | 4.060" Head Gasket .030" MLS All Twin Cam Models 103" & 113" 1999-16 | \$44.99 |
| C9070-040 | 4.060" Head Gasket .040" MLS All Twin Cam Models 103" & 113" 1999-16 | \$44.99 |
| C9910 | 4.125" Head Gasket .030" MLS All Twin Cam Models 107" & 117" 1999-16 | \$44.99 |
| C9743 | 4.125" Head Gasket .040" MLS All Twin Cam Models 107" & 117" 1999-16 | \$44.99 |
| C9076-030 | 4.250" Head Gasket .030" MLS All Twin Cam Models 114" & 124" 1999-16 | \$44.99 |
| C9076-040 | 4.250" Head Gasket .040" MLS All Twin Cam Models 114" & 124" 1999-16 | \$44.99 |
| Twin Cam SLS Base Gasket (Pairs) Single Layer Steel 1999-16 | | |
| C9937 | 4" Twin Cam Base gasket .010" Pair | \$23.85 |
| C9738 | 4" Twin Cam Base gasket .020" Pair | \$23.85 |
| C10127 | 4" CV0110 All Twin Cam Models 2007-16, Base Seal Kit | \$6.50 |
| C9110-010 | 4.060" Twin Cam Base gasket .010" SLS, Pair | \$23.85 |
| C9110-020 | 4.060" Twin Cam Base gasket .020" SLS, Pair | \$23.85 |
| C10066 | 4.125" Twin Cam Base gasket .010" SLS, Pair Stock base pattern | \$23.85 |
| C10066-020 | 4.125" Twin Cam Base gasket .020" SLS, Pair Stock base pattern | \$23.85 |
| C9938 | 4.125" Twin Cam Base gasket .010" Pair | \$23.85 |
| C9739 | 4.125" Twin Cam Base gasket .020" Pair | \$23.85 |
| C9111-010 | 4.250" Twin Cam Base gasket .010"SLS Pair | \$23.85 |
| C9111-020 | 4.250" Twin Cam Base gasket .020"SLS Pair | \$23.85 |
| S&S Head Gaskets | | |
| C9930 | S&S Super Sidewinder + 4 1/8" H/G Pair .027" MLS | \$44.99 |
| C9931 | S&S Super Sidewinder + 4 1/8" H/G Pair .030" MLS | \$44.99 |
| C9932 | S&S Super Sidewinder + 4 1/8" H/G Pair .036" MLS | \$44.99 |
| C9933 | S&S Super Sidewinder + 4 1/8" H/G Pair .040" MLS | \$44.99 |
| C9934 | S&S Super Sidewinder + 4 1/8" H/G Pair .045" MLS | \$44.99 |
| C10090 | S&S Twin Cam 131"cu 4.250" H&B Kit, .040"MLS H/G & .010" SLS Base | \$68.84 |
| C10065 | S&S Tribute pattern 4 3/8" H/G Pair .040" MLS | \$44.99 |
| C10065-045 | S&S Tribute pattern 4 3/8" H/G Pair .045" MLS | \$44.99 |
| S&S Base Gaskets | | |
| C9935 | S&S Super Sidewinder + 4 1/8" Base gasket pair .010" | \$23.85 |
| C9936 | S&S Super Sidewinder + 4 1/8" Base gasket pair .020" | \$23.85 |
| C10009 | S&S EVO 1984-99 Fits S&S only .020" Fiber (93-1033) | \$23.85 |
| Street 500 & 750 Head & Base Gaskets 2014-16 | | |
| C10134 | Street 500 H/G 69MM Stock Bore,.036"MLS (Pair) | \$42.50 |
| C10134-HB | Street 500 H/G 69MM Stock Bore,.036"MLS Heaad & Base Kit | \$56.95 |
| C10135 | Street 500 H/G 71MM Big Bore,.036"MLS (Pair) | \$42.50 |
| C10135-HB | Street 500 H/G 71MM Big Bore,.036"MLS Heaad & Base Kit | \$56.95 |
| C10136 | Street 700 H/G 85MM Stock Bore,.036"MLS (Pair) | \$42.50 |
| C10136-HB | Street 700 H/G 85MM Stock Bore,.036"MLS Heaad & Base Kit | \$56.95 |
| C10137 | Street 700 H/G 87MM Big Bore,.036"MLS (Pair) | \$42.50 |
| C10137-HB | Street 700 H/G 87MM Big Bore,.036"MLS Heaad & Base Kit | \$56.95 |
| EVO Big Twin & Sportster MLS Head Gaskets (Pairs) | | |
| C10003 | XR1200 STD Bore MLS Head gasket .040" 2008-12 | \$44.99 |
| C10004 | XR1200 3.812" Bore MLS Head gasket .040" 2008-12 | \$44.99 |
| C10004-030 | XR1200 3.812" Bore MLS Head gasket .030" 2008-12 | \$44.99 |
| C10077 | XR1200 3.563" Bore Head & Base Kit .030"H/G & .020" Base, 2008-12 | \$68.80 |
| C10057 | XR1200 3.875" Bore .030" MLS Head gasket & .020" Base set 2008-12 | \$68.80 |
| C9205 | 883 XL 3.000" Std bore .040" 1984-16 | \$44.99 |
| C9688 | Stock EVO's 3.500" through 3.570" .030" 1984-99 B/T, 1984-16 XL | \$44.99 |
| C9689 | Stock EVO's 3.500" through 3.570" .040" 1984-99 B/T, 1984-16 XL | \$44.99 |
| C9180 | Stock EVO's 3.500" through 3.570" .060" 1984-99 B/T, 1984-16 XL | \$66.83 |



Gaskets for Harley-Davidson®

MLS® Multi-Layer Steel

Head & Base Gaskets

| Part # | Description | Price |
|--|--|---------|
| EVO Big Twin & Sportster MLS Head Gaskets (Pairs) con't | | |
| C9690 | 3 5/8" Big Bore EVO's .030" 1984-99 B/T, 1984-16 XL | \$44.99 |
| C9691 | 3 5/8" Big Bore EVO's .040" 1984-99 B/T, 1984-16 XL | \$44.99 |
| C9694 | 3 3/4" Big Bore EVO's .030" 1984-99 B/T, 1984-16 XL | \$44.99 |
| C9695 | 3 3/4" Big Bore EVO's .040" 1984-99 B/T, 1984-16 XL | \$44.99 |
| C9692 | 3 13/16" Big Bore EVO's .030" 1984-99 B/T, 1984-16 XL | \$44.99 |
| C9693 | 3 13/16" Big Bore EVO's .040" 1984-99 B/T, 1984-16 XL | \$44.99 |
| C10120 | 3.875" Big Bore EVO's .040" 1984-99 B/T, 1984-16 XL | \$44.99 |
| C9877 | 4.000" Bore S&S and TP cylinders .027" solid dowels | \$44.99 |
| C9878 | 4.000" Bore S&S and TP cylinders .030" solid dowels | \$44.99 |
| C9879 | 4.000" Bore S&S and TP cylinders .036" solid dowels | \$44.99 |
| C9880 | 4.000" Bore S&S and TP cylinders .040" solid dowels | \$44.99 |
| C9881 | 4.125" Bore TP cylinders .027" solid dowels | \$44.99 |
| C9882 | 4.125" Bore TP cylinders .030" solid dowels | \$44.99 |
| C9883 | 4.125" Bore TP cylinders .036" solid dowels | \$44.99 |
| C9884 | 4.125" Bore TP cylinders .040" solid dowels | \$44.99 |
| C10069 | 4.250" Bore S&S and TP cylinders head & Base kit .030" head, .020" base | \$55.13 |
| EVO Big Twin SLS Base Gaskets (Pairs) Single Layer Steel | | |
| C9101 | 1340 Evolution B/T STD bore .010" 1984-99 | \$23.85 |
| C9551 | 1340 Evolution B/T STD bore .020" 1984-99 | \$23.85 |
| C9532 | 3 5/8" & 3 3/4" Big Bore 1340 B/T EVO's .010" 1984-99 | \$23.85 |
| C9552 | 3 5/8" & 3 3/4" Big Bore 1340 B/T EVO's .020" 1984-99 | \$23.85 |
| C9869 | 3 13/16" Evolution B/T .010" 1984-99 | \$23.85 |
| C9870 | 3 13/16" Evolution B/T .020" 1984-99 | \$23.85 |
| C9871 | 4.000" S&S and TP cylinder .010" | \$23.85 |
| C9872 | 4.000" S&S and TP cylinder .020" | \$23.85 |
| C9873 | 4.125" TP cylinder .010" | \$23.85 |
| C9874 | 4.125" TP cylinder .020" | \$23.85 |
| EVO Sportster SLS Base Gaskets (Pairs) Single Layer Steel | | |
| C9100 | 883/1200 EVO Sportsters .010" 1984-16 | \$23.85 |
| C9553 | 883/1200 EVO Sportsters .020" 1984-16 | \$23.85 |
| C9554 | 3 5/8" Big Bore 883/1200 EVO Sportsters .010" (Also fits Wiseco 3 3/4" Steel Sleeve Big Bore) | \$23.85 |
| C9555 | 3 5/8" Big Bore 883/1200 EVO Sportsters .020" (Also fits Wiseco 3 3/4" Steel Sleeve Big Bore) | \$23.85 |
| C9875 | 3 3/4" & 3 13/16" Evo Sporty Millenium Cylinders .010" (Either bore utilizes a 4.00" O.D. Spigot Diameter) ... | \$23.85 |
| C9876 | 3 3/4" & 3 13/16" Evo Sporty Millenium Cylinders .020" (Either bore utilizes a 4.00" O.D. Spigot Diameter).... | \$23.85 |
| Shovelhead and Panhead MLS Head Gaskets (Pairs) | | |
| C9984 | Std Bore Head Gasket .040" MLS Shovelhead 74" & 80" 1966-84 | \$44.99 |
| C9985 | 3 5/8" Head Gasket .040" MLS Shovelhead Big Bore 1966-84 | \$44.99 |
| C10037 | 3 13/16" Head Gasket .040" MLS Shovelhead Big Bore 1966-84 | \$44.99 |
| C9137 | Head Gasket .040" MLS Panhead Std. Bore 1948-65 | \$44.99 |
| C10070 | 3 5/8" Bore Head Gasket .040" MLS Panhead 1948-65 | \$44.99 |
| Shovelhead and Panhead SLS Base Gaskets (Pairs) | | |
| C9206 | Shovel Only Base Gasket Std bore .020" Viton Front & Rear Pair 1966-84 | \$23.85 |
| C9207 | 3 5/8" Shovel Only Base Gasket .020" Viton 2 Fronts for S&S Cylinders 1984-99 | \$23.85 |
| C10038 | 3 13/16" Shovel Only Base Gasket .020" Viton 2 Fronts for S&S Cylinders | \$23.85 |
| C9987 | Panhead Base Front & Rear Set .020" Viton 1948-84 | \$23.85 |
| C9988 | Panhead Base 3 5/8" Front & Rear Set .020" Viton 1948-84 | \$23.85 |
| C9989 | Panhead Base 3 5/8" 2 Fronts for S&S Cylinders Viton 48-84 | \$23.85 |
| C9893 | Panhead Base 3 13/16" .020" Viton 1948-84 | \$23.85 |
| C10116 | 48-84 Pan/Shovel Pair, No Oil Hole, .020" Fiber STD bore | \$19.98 |
| C10117 | 48-84 Pan/Shovel Pair, No Oil Hole, .020" Fiber 3 5/8" bore | \$19.98 |

EVO Viton Coated Steel Rocker Cover Gaskets

| Part# | Description / Qty. | Thickness | Price | Part# | Description / Qty. | Thickness | Price |
|-------|---------------------------------------|-----------|---------|-----------|---------------------------------------|-----------|----------|
| C9865 | 84-99 One piece Base All Evo's (2) | .020" | \$15.38 | C9560 | Right - All 883 thru 1340, '84-99 (5) | .010" | \$21.18 |
| C9866 | 84-99 One piece Base All Evo's (10) | .020" | \$77.23 | C9561 | Right - All 883 thru 1340, '84-99 (5) | .020" | \$21.18 |
| C9556 | Right - All 883 thru 1340, '84-99 (1) | .010" | \$4.65 | C9562 | Left - All 883 thru 1340, '84-99 (5) | .010" | \$25.21 |
| C9557 | Right - All 883 thru 1340, '84-99 (1) | .020" | \$4.65 | C9563 | Left - All 883 thru 1340, '84-99 (5) | .020" | \$25.21 |
| C9558 | Left - All 883 thru 1340, '84-99 (1) | .010" | \$5.34 | C9986 | 66-84 Shovelhead / OE#17540-69 (2) | .020" | \$21.18 |
| C9559 | Left - All 883 thru 1340, '84-99 (1) | .020" | \$5.34 | C10008 | 66-84 Shovelhead / OE#17540-69 (2) | .043" | \$21.18 |
| | | | | C10008-10 | 66-84 Shovelhead / OE#17540-69 (10) | .043" | \$105.90 |

Twin Cam®

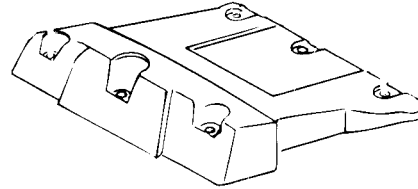

Cometic Part #-C9577
Rocker Cover
All 1999-UP
Replaces: 17286-99

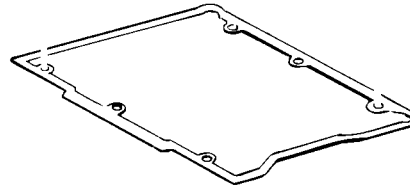

Cometic Part #-C9579
Breather Cover
All 1999-10
Replaces: 17591-99

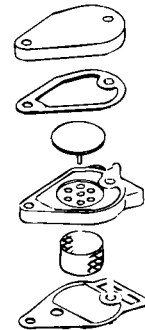

Cometic Part #-C9633
Rocker Umbrella Valve
All 1999-UP
Replaces: 26858-99

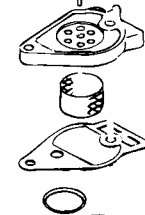

Cometic Part #-C9679
Breather Baffle Element
All 1999-UP
Replaces: 63815-99



Cometic Part #-C9580
Breather Baffle Housing
All 1999-10
Replaces: 17592-99

Cometic Part #-C9294
Pushrod Cover
O-Ring Upper
Replaces: 11293

Cometic Part #-C9629
Rocker Arm Support
O-Ring
All 1999-UP
Replaces: 11270

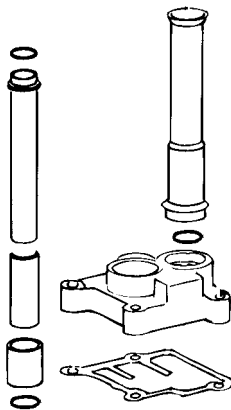

Cometic Part #-C9293
Pushrod Cover
O-Ring Lower
Replaces: 11145

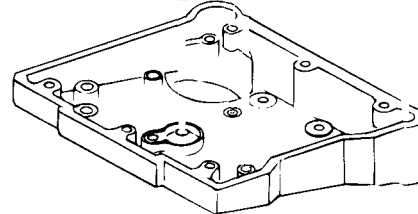

Cometic Part #-C9576
Rocker Housing
All 1999-UP
Replaces: 16719-99

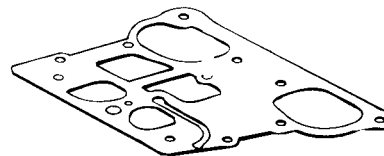

Cometic Part #-C9836
Valve Stem Seal Viton
All 1999-03
Replaces: 18001-83B

Cometic Part #-C9459
Pushrod Cover
O-Ring Middle
Replaces: 11132

Cometic Part #-C9578
Lifter Cover 1999-UP
Replaces: 18635-99

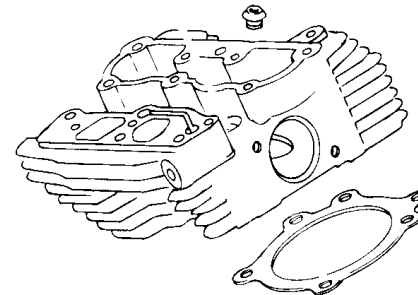

Cometic Part #-C9153
Valve Stem Seal Hat Style
Viton
2003-Present
Replaces: 18094-02

- Cometic Part #-C9790 Std. Bore Head - MLS .030" - All 1999-UP
- Cometic Part #-C9745 Std. Bore Head - MLS .040" - All 1999-UP
- Cometic Part #-C9721 1550 Big Bore Head - MLS .030" - All 1999-UP
- Cometic Part #-C9722 1550 Big Bore Head - MLS .040" - All 1999-UP



Gaskets for Harley-Davidson®



Complete • Top End • Rocker Box Kits & Individual Replacement Parts

| Part # | Description | Price |
|---|---|----------|
| EST TWIN CAM HI-PERFORMANCE KITS | | |
| • Complete Gasket Kit (Kits do not contain spacer for 07 models, order seperately) | | |
| C9171 | 07-16 All Softail, Std. Bore 3.750" .040" Head Gasket..... | \$215.89 |
| C9184 | 07-16 All Softail, 103" Big Bore 3.875", Std bore 2012-Up all Softail..... | \$215.89 |
| C10100 | 07-16 All Softail models 4.125" bore w/.040" H/G | \$215.89 |
| C10100-030 | 07-16 All Softail models 4.125" bore w/.030" H/G | \$215.89 |
| C9172 | 07-16 All FL Models, Std. Bore 3.750" .040" Head Gasket..... | \$215.89 |
| C9185 | 07-16 All FL Models, 103" Big Bore 3.875", Std bore 2012-Up all FL Models..... | \$215.89 |
| C10044 | 07-16 All FL Models, Big Bore 3.937" .040" Head Gasket..... | \$215.89 |
| C10044-030 | 07-16 All FL Models, Big Bore 3.937" .030" Head Gasket..... | \$215.89 |
| C10012 | 07-16 All FL Models, 113" Big Bore 4.060" .040" Head Gasket & .020" Base Gasket | \$215.89 |
| C10067 | 07-16 All FL Models, 117" Big bore 4.125" .030"h/g & .020" Base Gasket..... | \$215.89 |
| C9148 | 06-16 Dyna Models, Std. Bore 3.750" .040" Head Gasket..... | \$157.24 |
| C9186 | 06-16 Dyna Models, 103" Big Bore 3.875", Std bore 2012-Up Dyna Models | \$215.89 |
| C9149 | 06-16 Dyna Models, 95" & 103" BB w/.030" Head Gasket,Std bore '12-Up Dyna Models..... | \$157.24 |
| C10123 | 06-14 DYNA Models 107", 3.937" bore w/.040"Head Gasket & Base O-ring | \$157.24 |
| C10123-030 | 06-14 DYNA Models 107", 3.937" bore w/.030"Head Gasket & Base O-ring | \$157.24 |
| C10105 | 06-14 DYNA Models 110", 4" bore w/.040"Head Gasket & .020" base..... | \$215.89 |
| C10113 | 06-14 DYNA Models 113", 4.060" bore w/.040"Head Gasket & .020" base..... | \$157.24 |
| C9777F | 99-06 Softails, 99-05 Dyna Std. Bore 3.750" .040" thick head gasket..... | \$215.89 |
| C9778F | 99-06 FLT's, Road King, Std. Bore 3.750" .040" thick head gasket..... | \$212.32 |
| C9920 | 99-06 All Twin Cam Models, 99-05 Dyna 3.875" Big Bore Kits w/.040" Head Gasket | \$157.24 |
| C9161 | 99-06 All Twin Cam Models, 99-05 Dyna 3.875" Big Bore Kits w/.030" Head Gasket | \$157.24 |
| C10112 | 99-06 All Twin Cam Models 99-05 Dyna, 3.937" Big Bore Kit w/ .030"H/G | \$157.24 |
| C10102 | 99-06 All FL Models 3.937" Big Bore kit w/ .040" Head Gasket | \$212.32 |
| C10102-030 | 99-06 All FL Models 3.937" Big Bore kit w/ .030" Head Gasket | \$212.32 |
| C9807F | 99-06 FXST, 99-05 Dyna 4" Big Bore Kits .030" Head Gasket..... | \$144.70 |
| C10005 | 99-06 All FL Models 4" Big Bore kit w/ .030" Head Gasket..... | \$215.89 |
| C10118 | 99-05 4.060" Dyna & 99-06 Softails .030" Head Gasket & .010" Base | \$157.24 |
| C9221 | 99-05 4 1/8" Dyna & 99-06 Softails .040" Head Gasket & .010" Base | \$157.24 |
| C9221-030 | 99-05 4 1/8" Dyna & 99-06 Softails .030" Head Gasket & .010" Base | \$157.24 |
| C9222 | 99-06 4 1/8" FLT/FXR .040" Head Gasket & .010" Base | \$157.24 |
| C9222-030 | 99-06 4 1/8" FLT/FXR .030" Head Gasket & .010" Base | \$157.24 |
| • Top End Gasket Kit | | |
| C10041 | S&S 4.125" Bore SSW Top End kit .030" Head Gasket..... | \$130.14 |
| C10041-030 | S&S 4.125" Bore SSW Top End kit .027" Head Gasket..... | \$130.14 |
| C9146 | 03-16 All Twin Cam Std Bore 3.750" W / Hat Style Valve Stem Seal..... | \$111.47 |
| C9147 | 03-16 All Twin Cam 95" & 103" Big Bore Kit 3.875" w/Hat Style Valve Stem Seal | \$111.47 |
| C9844 | 03-16 All Twin Cam 95" & 103" Big Bore Kit 3.875" w/ .030" Head Gasket..... | \$111.47 |
| C9779 | 99-02 All Twin Cam 3.750" Bore W / .040" Head Gasket | \$137.71 |
| C9845 | 99-02 All Twin Cam 3.750" Bore W / .030" Head Gasket | \$111.47 |
| C9951-051 | 99-16 All Twin Cam 3.875" Big Bore Kit W / .051" Head Gasket..... | \$111.47 |
| C9951 | 99-16 All Twin Cam 3.875" Big Bore Kit W / .045" Head Gasket..... | \$111.47 |
| C9780 | 99-16 All Twin Cam 3.875" Big Bore Kit W / .040" Head Gasket..... | \$135.77 |
| C9182 | 99-16 All Twin Cam 3.937" Bore TOP END EST KIT, .040" MLS H/G | \$137.71 |
| C10034 | 99-16 All Twin Cam 3.937" Bore TOP END EST KIT, .030" MLS H/G | \$111.47 |
| C10138 | 07-16 All Twin Cam CVO110, 4" Bore T/E W/.040"MLS H/G, Air or Twin Cooled | \$136.95 |
| C10138-030 | 07-16 All Twin Cam CVO110, 4" Bore T/E W/.030"MLS H/G, Air or Twin Cooled | \$136.95 |
| C10082 | 120R Top End Kit 4.060" Bore W/ .040" Head & .020" Base | \$111.47 |
| C10082-030 | 120R Top End Kit 4.060" Bore W/ .030" Head & .020" Base | \$111.47 |
| C9114 | 99-16 All Twin Cam 4.060" TOP END EST KIT, .040"MLS H/G, .010" Steel Base | \$115.45 |
| C9114-030 | 99-16 All Twin Cam 4.060" TOP END EST KIT, .030"MLS H/G, .010" Steel Base | \$115.45 |
| C9949 | 99-16 4.00" Bore Twin Cam .040" Head Gasket & .010" Base..... | \$113.99 |
| C9976 | 99-16 4 1/8" Bore Twin Cam .040" Head Gasket & .020" Base..... | \$111.47 |
| C9976-030 | 99-16 4 1/8" Bore Twin Cam .030" Head Gasket & .020" Base..... | \$111.47 |
| C9238 | 99-16 4 1/4" Bore Twin Cam .040" Head Gasket & .010" Base..... | \$111.47 |
| C9789 | 99-16 All Twin Cam FATSO Top End..... | \$111.47 |
| C10015 | All Twin Cam 3.750" Bore .040" Head Gasket..... | \$125.73 |



Gaskets for Harley-Davidson®



Cometic Gasket - An Exclusive NASCAR Performance® Product

Complete • Top End • Rocker Box Kits & Individual Replacement Parts

Table with 3 columns: Part #, Description, Price. Includes sections for Motor Only Gasket Kit, Rocker Box Gasket Kit for 88", 95" & 103" Twin Cam, and Twin Cam Engine & Trans Cover Gasket Kit.

Table with 5 columns: Cometic Part #, OEM Part #, Description, Pkg. Qty., Price.

TWIN CAM INDIVIDUAL REPLACEMENT GASKETS, SEALS, O-RINGS 1999-UP

Table with 5 columns: Part #, Description, Pkg. Qty., Price. Includes Cam Service Kits for Twin Cam.

Twin Cooled Coolant Service Parts

Table with 5 columns: Part #, Description, Pkg. Qty., Price. Includes Twin Cooled O-Ring Kit.

Rocker Box Assembly Gaskets

Table with 5 columns: Part #, Description, Pkg. Qty., Price. Lists various rocker box assembly gaskets.

Pushrod, Tappet Gaskets and Valve Stem Seals

Table with 5 columns: Part #, Description, Pkg. Qty., Price. Lists pushrod, tappet gaskets, and valve stem seals.

Head and Base Gaskets

Table with 5 columns: Part #, Description, Pkg. Qty., Price. Lists head and base gaskets.



Gaskets for Harley-Davidson®



Cometic Gasket - An Exclusive NASCAR Performance® Product

Complete • Top End • Rocker Box Kits & Individual Replacement Parts

Table with 5 columns: Cometic Part #, OEM Part #, Description, Pkg. Qty., Price. Includes sections for Motor Case O-rings and Seals, Intake and Exhaust Gaskets, Oil and Oil Pump Gaskets, Primary Housing Gaskets, Cam Housing, and Carb and EFI Gaskets.

Evo Big Twin®

Cometic Part #-C9459
Pushrod O-Ring
Middle 1984-99
Replaces: 11132

Cometic Part #-C9481
Umbrella Valve Seal
1993-99
Replaces: 26856-89

Cometic Part #-C9286
Rocker Cover Washer
1984-99
Replaces: 63858-49

Cometic Part #-C9293
Pushrod O-Ring
Lower 1984-99
Replaces: 11145

Cometic Part #-C9292
Pushrod O-Ring
Upper 1984-99
Replaces: 11157

Cometic Part #-C9278
Upper Rocker Cover
1992-99
Replaces: 17356-92

Cometic Part #-C9297
Rear Tappet Block
Replaces: 18633-48D
Cometic Part #-C9298
Front Tappet Block
Replaces: 18634-48C

Cometic Part #-C9328
Cam Cover 1993-99
Replaces: 25225-93
Cometic Part #-C9302
Cam Cover 1984-92
Replaces: 25225-70B

Cometic Part #-C9282
Lower Rocker Cover
1992-99
Replaces: 17355-92

Cometic Part #-C9283
Inner Rocker Cover
1984-99
Replaces: 17358-84A

Cometic Part #-C9435
Check Valve & Check Ball Cap O-Ring,
All Big Twins Replaces: 11105

Cometic Part #-C9384
Oil Pump Cover 1992-99
Replaces: 26276-92

Cometic Part #-C9382
Oil Pump Cover 1984-91
Replaces: 26276-80A

Cometic Part #-C9350
Cam Seal 1984-99
Replaces: 83162-51DL

Cometic Part #-C9865
One Piece Rocker Base
1984-99
Replaces: 16778-97X &
16779-97X

Cometic Part #-C9836
Valve Stem Seal
1984-99
Replaces: 18001-83A

Cometic Part #-C9383
Oil Pump Body 1992-99
Replaces: 26273-92

Cometic Part #-C9381
Oil Pump Body 1984-91
Replaces: 26273-80B

Cometic Part #-C9290
Intake Manifold Seal
1990-99
Replaces: 26995-86A

Cometic Part #-C9349
Oil Pump Drive Gear Seal, 1984-99
Replaces: 26227-58

Cometic Part #-C9719
Race Style Exhaust
1984-99 "Flat"
Replaces: 65424-83
Cometic Part #-C9288
Std. Exhaust "Tapered"
Replaces: 65324-83A

Cometic Part #-C9684
Oil Pump Lower Cover O-Ring All Big Twins, 1992-98
Replaces: 11241

Cometic Part #-C9688 Std. Bore Head - MLS .030" - 1984-99
Cometic Part #-C9689 Std. Bore Head - MLS .040" - 1984-99



Gaskets for Harley-Davidson®



Cometic Gasket - An Exclusive NASCAR Performance® Product

Complete • Top End • Rocker Box Kits & Individual Replacement Parts

Part # Description Price

EST BIG TWIN EVOLUTION MOTOR KITS

• Complete Gasket Kit

Table with 3 columns: Part #, Description, Price. Rows include C9748F, C9846F, C9751F, C9849F, C9750F, C9848F, C9749F, C9847F.

• Big Bore Complete Gasket Kit

Table with 3 columns: Part #, Description, Price. Rows include C9908, C9164, C10013, C10013-030, C10064, C9974, C9940, C10103.

• Top End Gasket Kit

Table with 3 columns: Part #, Description, Price. Rows include C9635, C9850, C9130, C9747, C9851, C10130.

• Evo Big Twin Motor Only Gasket Kit

Table with 3 columns: Part #, Description, Price. Rows include C9890, C10119, C9891.

• Big Bore Top End Gasket Kit

Table with 3 columns: Part #, Description, Price. Rows include C9766, C9767, C9770, C9771, C9768, C9980, C9769, C9917, C9917S, C9959.

• Rocker Box Rebuild Gasket Kit

Table with 3 columns: Part #, Description, Price. Rows include C9752, C9753.



Gaskets for Harley-Davidson®



Cometic Gasket - An Exclusive NASCAR Performance® Product

Complete • Top End • Rocker Box Kits & Individual Replacement Parts

| Cometic Part # | OEM Part # | Description | Pkg. Qty. | Price |
|---|------------|---|-----------|---------|
| 1984-99 BIG TWIN & EVO INDIVIDUAL REPLACEMENT GASKETS,SEALS, O-RINGS | | | | |
| Rocker Box Gaskets | | | | |
| C9481 | 26856-89 | 93-99 Umbrella Valve Seal | 10 | \$10.56 |
| C9400 | 6114 | 84-99 Rocker Box Washer copper | 10 | \$6.58 |
| C9286 | 63858-49 | 84-99 Rocker Box Washer paper | 10 | \$5.86 |
| C9277 | 17356-84A | 84-91 Upper Rocker Cover Gasket rubber | 5 | \$29.19 |
| C9278 | 17356-92 | 92-99 Upper Rocker Cover Gasket rubber | 5 | \$29.19 |
| C9283 | 17358-84A | 84-99 Inner Rocker Cover Gasket rubber | 10 | \$18.56 |
| C9281 | 17355-84A | 84-91 Lower Rocker Cover Gasket rubber | 5 | \$29.19 |
| C9282 | 17355-92 | 92-99 Lower Rocker Cover Gasket rubber | 5 | \$29.19 |
| C9561 | 16778-97X | 84-99 Lower Right Rocker Gasket .020" rubber coated steel | 5 | \$21.18 |
| C9285 | 16778-84A | 84-99 Lower Right Rocker Gasket fiber | 5 | \$10.56 |
| C9563 | 16779-97X | 84-99 Lower Left Rocker Gasket .020" rubber coated steel | 5 | \$25.21 |
| C9284 | 16779-84A | 84-99 Lower Left Rocker Gasket fiber | 5 | \$17.21 |
| C9865 | | 84-99 One piece Rocker Base all Evo's .020" rubber coated steel | 2 | \$15.38 |
| C9866 | | 84-99 One piece Rocker Base all Evo's .020" rubber coated steel | 10 | \$77.23 |
| C9224 | | S&S Outer Rocker Gasket w/ Breather Flapper | 4 | \$40.40 |
| C9225 | | S&S Inner Rocker O-Ring Seal | 8 | \$12.67 |
| C9226 | | S&S Rocker Cover Bolt Washer Seal | 24 | \$22.93 |
| • Pushrod and Tappet Guide Gaskets | | | | |
| C9292 | 11157 | 84-99 Upper Pushrod Tube O-ring | 25 | \$20.33 |
| C9459 | 11132 | 84-99 Middle Pushrod Tube O-ring | 25 | \$3.92 |
| C9293 | 11145 | 84-99 Lower Pushrod Tube O-ring | 25 | \$7.95 |
| C10023 | | 84-99 Tappet Block Pair Front & Rear .060" AFM Pair | 2 | \$8.86 |
| C9297F | 18633-48D | 84-99 Rear Tappet Block Gasket AFM | 10 | \$6.58 |
| C9298F | 18634-48C | 84-99 Front Tappet Block Gasket AFM | 10 | \$7.95 |
| C9586 | | 84-99 Evo Pushrod O-ring Set | Kit | \$4.32 |
| C9836 | | 84-99 Valve Guide Seals "Viton" | 25 | \$73.42 |
| • Head and Base Gaskets | | | | |
| C9688 | | Stock Bore EVO's 3.500" through 3.570" .030" MLS Design | 2 | \$44.99 |
| C9689 | | Stock Bore EVO's 3.500" through 3.570" .040" MLS Design | 2 | \$44.99 |
| C9690 | | 3 5/8" Big Bore EVO's .030" MLS Design | 2 | \$44.99 |
| C9691 | | 3 5/8" Big Bore EVO's .040" MLS Design | 2 | \$44.99 |
| C9694 | | 3 3/4" Big Bore EVO's .030" MLS Design | 2 | \$44.99 |
| C9695 | | 3 3/4" Big Bore EVO's .040" MLS Design | 2 | \$44.99 |
| C9692 | | 3 13/16" Big Bore EVO's .030" MLS Design | 2 | \$44.99 |
| C9693 | | 3 13/16" Big Bore EVO's .040" MLS Design | 2 | \$44.99 |
| C9287 | 26432-76A | 84-99 Cylinder Stud Insert O-ring | 10 | \$11.93 |
| C9551 | | 84-99 Stock Sleeve Cylinder Base Gasket .020" Rubber Coated Steel | 2 | \$23.85 |
| C9009 | 16774-86 | 84-99 Stock Sleeve Cylinder Base Gasket .020" Fiber | 2 | \$4.49 |
| C9615 | 16777-86S | 84-99 3 5/8" Base Gasket .020" Fiber | 2 | \$8.01 |
| C10009 | 93-1033 | 84-99 3 5/8" Base Gasket .020" Fiber fits S&S cylinder only | 2 | \$23.85 |
| C9552 | | 84-99 3 5/8" Base Gasket .020" Rubber Coated Metal | 2 | \$23.85 |
| C9615 | | 84-99 3 3/4" Base Gasket .020" Fiber | 2 | \$8.01 |
| C9082 | | 84-99 3 13/16" Head Gasket .043" Copper | 2 | \$39.70 |
| C9617 | | 84-99 3 13/16" Base Gasket .020" Fiber | 2 | \$4.02 |
| C9609 | | 84-99 4" Head Gasket .043" copper w / Axtell Cyl. | 2 | \$39.70 |
| C9621 | | 84-99 4" Base Gasket w / S&S Cyl. .020" Fiber | 2 | \$8.01 |
| • EVO Cam Service Kits | | | | |
| C9623 | | 1970-92 All Big Twins | Kit | \$22.99 |
| C9624F | | 1993-99 All Big Twins | Kit | \$18.56 |



Gaskets for Harley-Davidson®



Cometic Gasket - An Exclusive NASCAR Performance® Product

Complete • Top End • Rocker Box Kits & Individual Replacement Parts

| Cometic Part # | OEM Part # | Description | Pkg. Qty. | Price |
|--|------------|--|-----------|---------|
| • Cam Housing Gaskets | | | | |
| C9328F5 | 25225-93 | 93-99 Cam Cover Gasket AFM | 5 | \$33.50 |
| C9302F5 | 25225-70B | 84-92 Cam Cover Gasket AFM | 5 | \$29.58 |
| C9306F | 32591-80 | 84-99 Point Cover Gasket | 10 | \$11.13 |
| C9350 | 83162-51DL | 84-99 Point Seal double lip | 5 | \$18.56 |
| • Intake and Exhaust | | | | |
| C10035 | 54-0505 | Edlebrock rectangle port intake seal Pair | 2 | \$3.12 |
| C9227 | | 50mm Carb. to Manifold Seal 1999-UP | 1 | \$4.88 |
| C9131 | | All EVO Intake Manifold Seal Kit, Head to Manifold and Carb Seal | Kit | \$9.99 |
| C9088 | 27002-89 | 89 to Present Carb to Manifold Sealing Ring | 1 | \$6.58 |
| C9299 | 29242-83 | 84-89 Intake to Head Compliance Fitting Gasket | 10 | \$13.24 |
| C9290 | 26995-86A | 90-99 Intake to Head Compliance Fitting Gasket | 10 | \$19.87 |
| C9540 | 01-931 | Extreme Performance Exhaust Gasket | 10 | \$74.56 |
| C9719 | 65324-83 | 84-91 Exhaust Port Gasket Race Style | 10 | \$40.42 |
| C9288 | 65324-83A | 92-99 Exhaust Port Gasket Taper Style | 5 | \$47.81 |
| C9247 | | Exhaust Gasket All Models 99 -UP Race Style .240" thick | 10 | \$57.88 |
| C9223 | | S&S Big Bore Manifold to Head Seal | 4 | \$18.56 |
| • Oil Pump Gaskets and Seals | | | | |
| C10028 | | 81-91 Oil Pump Rebuild Kit | 1 | \$19.42 |
| C9168 | | 92-99 Oil Pump Rebuild Kit | 1 | \$19.42 |
| C9435 | 11105 | 84-99 Oil Pump Cap O-ring | 25 | \$4.54 |
| C9684 | 11241 | 92-99 Oil Pump Cover O-ring | 25 | \$2.56 |
| C9349 | 26227-58 | 84-99 Oil Pump Drive Gear Seal | 5 | \$11.93 |
| C9383 | 26273-92 | 92-99 Oil Pump Body Gasket paper | 10 | \$9.26 |
| C9381 | 26273-80B | 84-91 Oil Pump Body Gasket paper | 10 | \$9.26 |
| C9382 | 26276-80A | 84-91 Oil Pump Cover Gasket paper | 10 | \$7.95 |
| C9384 | 26276-92 | 92-99 Oil Pump Cover Gasket paper | 10 | \$9.26 |
| C10011 | 63528-92 | HD Oil Line Ferrule 92-98 ALL | 5 | \$16.12 |
| • Misc. O-ring and Seal | | | | |
| C9438 | 11170 | 95-99 Crankshaft Position Sensor O-ring | 25 | \$6.58 |
| C9351 | 12026B | 84-99 Sprocket Shaft Seal | 5 | \$14.59 |
| • Derby Cover Gaskets and O-rings | | | | |
| C9183F1 | 25416-70C | 84-98 All B/T 3 Hole | 1 | \$6.14 |
| C9338F5 | 25416-70C | 70-E84 Derby Cover Gasket , AFM60 | 5 | \$37.94 |
| • Inspection Cover Gaskets | | | | |
| C9442 | 25416-84 | L84-98 Derby Cover O-ring | 10 | \$17.21 |
| C9363 | 31433-84A | 84-98 Derby Cover Bolt Washer metal | 5 | \$6.42 |
| C9303F5 | 34906-79 | 80-84 FXR, FLT Primary Inspec. Cover Gasket, AFM60 | 5 | \$32.19 |
| C9305F5 | 34906-85 | 85-UP FXR, FLT Primary Inspection Cvr. Gasket, AFM60 | 5 | \$32.19 |
| C9326F5 | 60567-36 | 36-64 FL, FLTH, 58-69 XLCH Inspection Cover Gasket, AFM60 | 5 | \$20.55 |
| C9331F5 | 60567-65C | 65-UP Inspec. Cover Gasket Dyna & Softails, AFM60 | 5 | \$23.17 |
| • Inner Primary Gaskets, O-rings | | | | |
| C9536 | 11125 | 70-E82 Inner Primary O-ring | 10 | \$65.87 |
| C10125 | | 70-06 Engine Case Saver Gasket .060" AFM | 5 | \$37.50 |
| C9441 | 11147 | L82-99 Inner Primary O-ring | 10 | \$22.54 |
| C9518 | 12018 | 70-E84 Inner Primary Bearing Seal | 5 | \$14.59 |
| C9260 | 12052 | L84-99 Inner Primary Bearing Seal double lip | 5 | \$11.93 |
| C9343 | 60629-55 | 55-64 Chain Housing to Motor Gasket | 10 | \$22.32 |



Gaskets for Harley-Davidson®



Cometic Gasket - An Exclusive NASCAR Performance® Product

| Cometic Part # | OEM Part # | Description | Pkg. Qty. | Price |
|--|-------------|---|-----------|---------|
| • Starter Housing Gaskets, O-rings | | | | |
| C9451 | 11101 | L66-82 Starter Oil Deflector O-ring | 10 | \$4.49 |
| C9433 | 11116 | 91-99 Starter Housing O-ring | 25 | \$6.58 |
| C9436 | 11171 | 89-90 Starter Bolt O-ring | 10 | \$6.58 |
| C9491 | 12051 | L84-88 Starter Shaft Seal | 5 | \$11.93 |
| C9261 | 12066 | 94-99 Starter Shaft Seal | 5 | \$18.56 |
| C9379 | 12053 | 89-93 Starter Shaft Seal | 5 | \$18.56 |
| C9507F | 31320-80 | 80-86 Starter Housing Gasket | 10 | \$6.58 |
| C9508F | 31321-80 | 80-86 Starter Cover Gasket | 10 | \$13.92 |
| C9509 | 31341-80-DL | 80-86 Starter Shaft Seal | 5 | \$21.18 |
| C9717F | 60518-65 | 65-88 Starter Hole Block Off Gasket | 10 | \$26.69 |
| C9330F | 60559-80 | 65-85 Starter Housing Gasket | 10 | \$7.95 |
| C9702 | 60645-65 | 65-84 Solenoid Mount Gasket | 10 | \$7.84 |
| • Shifter Shaft Seals | | | | |
| C9484 | 11117 | L84-99 FXR,DYNA Shifter Sleeve O-ring | 25 | \$11.93 |
| C9357 | 11148 | 82-E84 Shifter Shaft Quad Seal | 10 | \$11.93 |
| C9661 | 11191 | 90-99 FXST, FLST Shift Lever O-ring | 25 | \$4.32 |
| C9525 | 60641-74 | 74-85 Shifter Shaft Seal | 5 | \$13.24 |
| 1936 BIG TWIN & EVO INDIVIDUAL REPLACEMENT GASKETS,SEALS, O-RINGS | | | | |
| Seals, O-rings and Washers | | | | |
| C9498 | 6007 | 80-98 Drain Plug Washer | 10 | \$8.41 |
| C9435 | 11105 | 90-99 Drain Plug O-ring | 10 | \$4.54 |
| C9529 | 11115 | 65-86 Counter Shaft O-ring | 10 | \$7.95 |
| C9459 | 11132 | 90-99 Dipstick Cover O-ring upper | 25 | \$3.92 |
| C9667 | 11140 | 96-99 Speedometer Sensor O-ring | 25 | \$3.92 |
| C9495 | 11162 | L84-86 Mainshaft O-ring right end | 25 | \$6.58 |
| C9361 | 11165 | L84-99 Mainshaft Quad Seal | 10 | \$13.24 |
| C9530 | 11166 | 84-86 Mainshaft Bearing O-ring | 25 | \$7.95 |
| C9263 | 11178 | 87-98 Filler Plug O-ring | 10 | \$5.28 |
| C9447 | 11179 | 87-99 Clutch Cable O-ring | 25 | \$3.92 |
| C9531 | 12010 | L79-86 Shifter Shaft Seal | 5 | \$11.93 |
| C9493 | 12013A | L81-86 Main Drive Gear Seal | 5 | \$11.18 |
| C9494 | 12014 | 65-E84 Clutch Hub Nut Seal | 5 | \$7.95 |
| C9518 | 12018 | 71-E84 Inner Primary Clutch Seal | 5 | \$14.59 |
| C9506 | 12022 | L66-E81 Main Drive Gear Seal | 5 | \$11.18 |
| C9351 | 12026B | 70-98 Mainshaft Seal, Engine | 5 | \$14.59 |
| C9258 | 12035A | 91-99 Main Drive Gear Seal, Transmission | 5 | \$9.26 |
| C9528 | 12043 | 80-86 Starter Shaft Seal | 5 | \$10.56 |
| C9527 | 12044DL | 80-E84 Main Drive Gear Seal | 1 | \$7.95 |
| C9259 | 12045DL | 80-06 Shifter Shaft Seal | 5 | \$11.93 |
| C9359 | 12050 | L84-94 Main Shaft Seal | 1 | \$5.28 |
| C9260 | 12052DL | L84-99 Inner Primary Clutch Seal | 5 | \$11.93 |
| C10110 | 12052-X | 84-14 Inner Primary Clutch seal for use w/ sealed bearing | 5 | \$26.50 |
| C9262 | 12067A | 95-99 Mainshaft Seal | 1 | \$6.58 |
| C9632 | 12068 | 99-UP Twin Cam, 04-UP Sportster Engine Main Shaft Seal | 5 | \$30.95 |
| C9497 | 33043-80 | 65-95 Neutral Indicator Washer | 10 | \$8.41 |
| C9374 | 33076-37 | 37-86 Starter Crank Seal | 10 | \$11.93 |
| C9519 | 34036-36 | 36-E79 Cam Shaft Seal rubber | 10 | \$6.58 |
| C9510 | 34036-80 | 80-86 Shift Fork Shaft O-ring | 10 | \$6.58 |
| C9523 | 35230-39DL | 36-79 Mainshaft Seal | 5 | \$21.18 |
| C9411 | 35231-36 | 36-E77 Mainshaft Oil Seal cork washer | 10 | \$7.95 |
| C9496 | 37091-80 | 80-86 Filler Plug Washer | 10 | \$17.54 |
| C9354 | 37101-84 | 84-86 Clutch Release Lever O-ring | 1 | \$2.61 |
| C9513 | 37741-67A | L79-81 Mainshaft Seal Double Lip | 5 | \$26.51 |
| C9514 | 37741-82DL | 82-86 Main Drive Gear Seal Double Lip | 5 | \$30.49 |
| C9485 | 62672-90 | 91-98 Dipstick Cover O-ring | 10 | \$6.58 |
| C9460 | 62673-90 | 91-98 Dipstick O-ring | 10 | \$3.92 |
| C9403 | 62702-52 | 36-86 Drain Plug Washer | 10 | \$11.93 |

Complete Transmission Kits & Individual Gaskets

Cometic Part #-C9459
Trans/Clutch Oil Dipstick
O-Ring, All Big Twin
Replaces: 11132

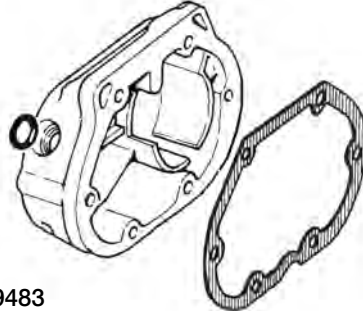

Cometic Part #-C9483
Clutch Release Cover
All Big Twin 88-06
Replaces: 36801-87B

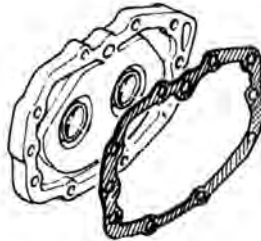

Cometic Part #-C9264
Trans Bearing Cover
All Big Twin 86-98
Replaces: 35652-79B
Cometic Part #-C9644
Trans Bearing Cover
All Big Twin 99-06
Replaces: 35653-98

Cometic Part #-C9459
Oil Tank Filler Cap O-Ring
Top, Dyna 91-98
Replaces: 11132

Cometic Part #-C9485
Oil Tank Filler Cap O-Ring
Bottom, Dyna 91-98
Replaces: 62672-90

Cometic Part #-C9460
Oil Dipstick O-Ring
Dyna 91-UP
Replaces: 62673-90

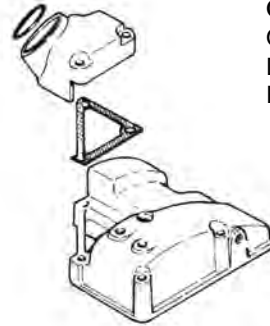

Cometic Part #-C94891F5
Oil Tank Spout
Dyna 91-UP
Replaces: 62423-90

Cometic Part #-C9488
Trans Top Cover
Dyna 91-98
Replaces: 34917-90A

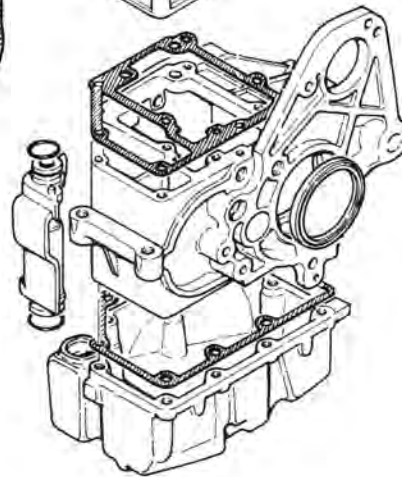

Cometic Part #-C9262
Trans Main Drive Seal
Big Twin L94-06
Replaces: 12067A

Cometic Part #-C9646
Oil Pan, Dyna 99-UP
Replaces: 26072-99
Cometic Part #-C9490
Oil Pan, Dyna 91-98
Replaces: 26072-90A

| Cometic Part # | OEM Part # | Description | Price |
|----------------|------------|-------------|-------|
|----------------|------------|-------------|-------|

1970-UP BIG TWIN EVO & TWIN CAM INDIVIDUAL REPLACEMENT GASKETS,SEALS, O-RINGS

•Complete Transmission Kits

| | | | |
|--------|----------|--|---------|
| C9464 | 33031-70 | E70-E 79 Big Twin | \$52.86 |
| C9464F | 33031-70 | E70-E 79 Big Twin EST Kit | \$32.82 |
| C9465 | 33031-80 | L79-82 Big Twin 4 Speed | \$49.45 |
| C9466 | 33031-82 | 80-E84 Big Twin 5 Speed | \$63.42 |
| C9467 | 33031-85 | L84-92 Big Twin Except Dyna 5 Speeds | \$75.24 |
| C9468 | 33031-91 | 91-99 Dyna & FXDB-S Evolution Models | \$40.99 |
| C9469 | 33031-93 | 93-99 FLT,FLH, FXR, Dyna & Softails Evolution Models w/Fiber | \$59.45 |
| C9469F | 33031-93 | 93-99 FLT,FLH, FXR, Dyna & Softails Evolution Models w/AFM | \$59.45 |
| C9639 | 26072-99 | 99-06 FLT, FLH, Softail 00-06, Twin Cam Models w/Fiber | \$34.47 |
| C9639F | 26072-99 | 99-06 FLT, FLH, Softail 00-06, Twin Cam Models w/AFM | \$29.82 |
| C9640 | 26072-99 | 99-05 Dyna Twin Cam Models | \$34.47 |
| C9151 | 06-16 | Dyna Twin Cam 6 Speed Trans Kit | \$54.68 |
| C9174 | 07-16 | Softail Models Twin Cam 6 Speed Trans Kit | \$75.24 |
| C9175 | 07-16 | FL Models Twin Cam 6 Speed Trans Kit | \$75.24 |

(Kit contains all of the necessary gaskets, seals, o-rings, end cover, top cover gaskets and all washers needed to completely rebuild the transmission)



Gaskets for Harley-Davidson®



Cometic Gasket - An Exclusive NASCAR Performance® Product

Complete Transmission Kits & Individual Gaskets

| Cometic Part # | OEM Part # | Description | Pkg. Qty. | Price |
|----------------|------------|-------------|-----------|-------|
|----------------|------------|-------------|-----------|-------|

1936-UP BIG TWIN EVO & TWIN CAM INDIVIDUAL REPLACEMENT GASKETS,SEALS, O-RINGS

• Transmission Gaskets

| | | | | |
|----------------------|------------|--|----|---------|
| C9434 | 11201 | T/C Mainshaft 5th Gear O-ring 07-16 | 10 | \$7.95 |
| C9642 | 11290 | Twin Cam Neutral Ind. Switch O-ring All Models 1999 -16 | 10 | \$11.98 |
| C9215 | 12074 | T/C Mainshaft Oil Seal 07-16 All, 06-16 Dyna | 1 | \$10.11 |
| C9200 | 12077 | 06 DYNA, All 07-16 Oil Seal Output Gear End Seal | 10 | \$67.57 |
| C9490F | 26072-90 | 90-98 Oil Pan Gasket Dyna | 10 | \$42.41 |
| C9646F | 26072-99 | T/C DYNA Oil Pan Gasket 1999-16 | 10 | \$92.33 |
| C9265F | 26077-93 | 93-98 Oil Pan Gasket FLT | 5 | \$46.17 |
| C9647F | 26077-99 | T/C Oil Pan Gasket FLT's 1999-16 | 10 | \$92.33 |
| C9517F | 33196-79 | L79-86 Shifter Cover Gasket | 10 | \$7.95 |
| C9515-032AFM33295-36 | | 36-86 End Cover Gasket | 10 | \$37.30 |
| C9520F | 34552-52 | 52-E79 Ratchet Cover Gasket | 10 | \$14.59 |
| C9521F | 34565-52 | 52-E79 Shifter Adapter Plate Gasket | 10 | \$6.58 |
| C9522F | 34824-36 | 36-E79 Top Cover Gasket | 10 | \$9.26 |
| C9516-032AFM34824-79 | | L79-86 Top Cover Gasket | 10 | \$6.58 |
| C9499F | 34904-79 | 80-86 Top Cover Gasket | 10 | \$29.24 |
| C9983F | 34904-86B | 87-99 Top Cover Gasket Thin Version | 10 | \$23.74 |
| C9267 | 34904-86XC | T/C Trans Cover Gasket All Models 1999 -16 Wide Version | 10 | \$23.34 |
| C9488F | 34917-90A | 90-98 Top Cover Gasket Dyna | 10 | \$33.99 |
| C9645F | 34917-99 | T/C DYNA Trans. Top Cover Gasket 1999-05 | 10 | \$23.34 |
| C9189 | 34917-06 | T/C Trans. Top Cover Gasket 07-16 All Models | 10 | \$23.29 |
| C9190F5 | 35607-06 | Trans to Eng. Case Gasket Dyna 06-UP & FL 07-16 Models | 1 | \$81.90 |
| C9264F | 35652-79A | 80-98 Bearing Housing Gasket | 10 | \$31.28 |
| C9644F | 35653-98 | T/C Bearing Housing Gasket All Models 1999 -06, 99-05 Dyna | 10 | \$25.90 |
| C9187 | 35654-06 | T/C Bearing Housing Gasket All Models 07 -14 | 10 | \$25.90 |
| C9526F | 36801-79 | 80-86 End Cover Gasket | 10 | \$17.43 |
| C9483F | 36801-87B | 87-05 Dyna, 87-06 All Models Clutch Release Gasket | 10 | \$24.99 |
| C9188 | 36805-06 | T/C Trans End Cover All Models 07-16 | 10 | \$24.99 |
| C9354F5 | 37101-84 | ALL T/C Shift Shaft Seal 09-16 | 5 | \$12.23 |
| C9489F | 62423-90 | 91-98 Dyna Oil Filler Spout Gasket | 10 | \$11.93 |
| C9266F | 62432-93 | 93-06 FLT Oil Filler Spout Gasket | 10 | \$46.17 |
| C9512F | 67141-36 | 36-83 Speedometer Drive Gasket | 10 | \$6.58 |

• Carburetor Gaskets

| | | | | |
|-------|----------|--|----|---------|
| C9452 | 11107 | 66-71 XL, 67-70 Big Twin Tillotson Spacer O-ring | 10 | \$10.56 |
| C9088 | 27002-89 | 88-98 XL, 90-99 Big Twin Keihin CV Seal Ring | 1 | \$6.58 |
| C9417 | 27023-71 | 72- E76, 79-85 XL; 71-75 Big Twin Bendix Manifold Gasket | 10 | \$6.14 |
| C9425 | 27077-78 | 78-89 Big Twin Keihin Manifold Gasket | 10 | \$6.58 |
| C9300 | 29058-77 | L76-87 XL, 76-89 Big Twin Keihin Air Cleaner Gasket | 10 | \$8.98 |
| C9301 | 29059-88 | 88-98 XL, 90-99 Big Twin Keihin CV Air Cleaner Gasket | 20 | \$16.69 |

Shovelhead & Panhead®

Cometic Part #-C9365
Oil Line Sleeve Seal
1963-84
Replaces: 63529-57

Cometic Part #-C9986
Rocker Cover Viton Coated Embossed
Shovelhead 1966-84

Cometic Part #-C9336
Rocker Cover 1966-84
Replaces: 17540-69

Cometic Part #-C9451
Upper Pushrod Cover
O-Ring Late 1979-81
Replaces: 11101

Cometic Part #-C9711
Upper Pushrod Cover
O-Ring Late 1981-84
Replaces: 11118

Cometic Part #-C9998
Valve Stem Seal 1980-84
Replaces: 18000-81

Cometic Part #-C9459
Middle Pushrod Cover
O-Ring Late 1979-84
Replaces: 11132

Cometic Part #-C9451
Rocker Shaft O-Ring
1966-84
Replaces: 11101

Cometic Part #-C9346
Rocker Cover Felt Pad
1948-65
Replaces: 17507-48

Cometic Part #-C9342
Rocker Cover 1948-65
Replaces: 17541-48A

Cometic Part #-C9604
Std. Bore Shovelhead
.043" Fire Ring Head
Replaces: 16770-66X

Cometic Part #-C9984
"MLS" Std. Bore
74 & 80 Shovelhead All
Models .040" Head

Cometic Part #-C9460
Lower Pushrod Cover
O-Ring 1979-81
Replaces: 11133

Cometic Part #-C9461
Lower Pushrod Cover
O-Ring Late 1981-84
Replaces: 11133A

Cometic Part #-C9598
Pushrod Cover (Small)
1948-65
Replaces: 17955-36

Cometic Part #-C9613
Head 1948-65
Replaces: 16770-48X

Cometic Part #-C9567
Pan/Shovel Front Cylinder Base
Gasket .031" (Fiber) 1948-84
Replaces: 16776-48

Cometic Part #-C9987
Shovel Front & Rear Pair
Std. 74 & 80 Cylinders
Viton Coated Embossed Base
Gasket

Cometic Part #-C9297
Rear Tappet Block
1948-84
Replaces: 18633-48D

Cometic Part #-C9606
Pushrod Cover (Large)
1948-E79
Replaces: 17955-48

Cometic Part #-C9568
Pan/Shovel Rear Cylinder Base
Gasket .031" (Fiber) 1948-84
Replaces: 16777-48

Cometic Part #-C9298
Front Tappet Block
1948-84
Replaces: 18634-48C



Gaskets for Harley-Davidson®



Cometic Gasket - An Exclusive NASCAR Performance® Product

Complete • Top End • Rocker Box Kits & Individual Replacement Parts

| Cometic Part # | OEM Part # | Description | Price |
|---|----------------|---|----------|
| EST MOTOR KITS FOR SHOVELHEAD & PANHEAD MOTORS | | | |
| • Complete EST Gasket Kits for Shovelhead/Panhead | | | |
| C9900..... | 17029-66..... | 1966-69 74" Shovelhead FL, FLH..... | \$167.56 |
| C9964..... | 17029-70A..... | 1970-84 74" & 80" Shovelhead 4 Spd..... | \$142.14 |
| C9154..... | | 1970-84 3 5/8" Shovelhead 4 Spd..... | \$184.94 |
| C9965..... | 17029-80..... | 1980-84 80" Shovelhead 5 Spd. FLT..... | \$204.88 |
| C9966..... | 17028-48..... | 1948-65 Panhead FL, FLH..... | \$142.14 |
| Motor Only Shovelhead Gasket Kits | | | |
| C10091..... | | 1970-84 STD Bore Engine Only Gasket & Seal Kit..... | \$105.00 |
| • Top End EST Gasket Kits for Shovelhead/Panhead | | | |
| C9967..... | 17034-66X..... | 1966-84 74" & 80" Shovelhead 4 or 5 Spd..... | \$100.11 |
| C9968..... | 17034-48..... | 1948-65 Panhead FL, FLH..... | \$100.11 |
| • Big Bore Shovelhead Top End Gasket Kits | | | |
| C9918..... | | 3 5/8" Bore 1966-84 All Models..... | \$100.11 |
| C9969..... | | 3 13/16" Bore 1966-84 All Models, No Oil Drains in Head Gasket..... | \$100.11 |

EST Kits contain MLS head gaskets, steel viton coated base gaskets and AFM material

| Cometic Part # | OEM Part # | Description | Pkg. Qty. | Price |
|---|----------------|---|-----------|---------|
| 1936-84 BIG TWIN PAN & SHOVEL INDIVIDUAL REPLACEMENT GASKETS, SEALS, O-RINGS | | | | |
| • Rocker Housing Gaskets and O-rings | | | | |
| C10030..... | 17535-38..... | 36-47 Knucklehead Frt Rocker Tin Gasket, .031" Fiber..... | 10..... | \$39.31 |
| C10031..... | 18265-37..... | 36-47 Knucklehead Valve Guide Gasket..... | 10..... | \$21.43 |
| C10008..... | 17540-69..... | 66-84 Rocker Cover Gasket .043" CFM20..... | 2..... | \$21.18 |
| C9986..... | 17540-69..... | 66-84 Rocker Cover Gasket .020" Viton Coated Emb. Steel..... | 2..... | \$21.18 |
| C9336..... | 17540-69..... | 66-84 Rocker Cover Gasket .031" Fiber..... | 10..... | \$18.79 |
| C9342..... | 17541-48A..... | 48-65 Rocker Cover Gasket .031" Fiber..... | 10..... | \$44.52 |
| C9346..... | 17507-48..... | 48-65 Rocker Cover Felt Pad..... | 10..... | \$22.54 |
| C9451..... | 11101..... | 66-84 Rocker Shaft O-ring..... | 25..... | \$4.49 |
| C9424..... | 18000-81..... | L81-84 Valve Guide Seal Teflon..... | 25..... | \$45.25 |
| C9419..... | 18196-51..... | 51-29 Valve Guide Gasket..... | 20..... | \$11.13 |
| C9998..... | | Late Shovelhead & .625" O.D. Guides Viton Seal with garter..... | 20..... | \$48.16 |
| • Pushrod O-rings and Tappet Block Gaskets | | | | |
| C9598..... | 17955-36..... | 36-E79 Push Rod Cover small cork..... | 25..... | \$8.75 |
| C9606..... | 17955-48..... | 48-E79 PushRod Cover Large cork..... | 25..... | \$7.95 |
| C9451..... | 11101..... | L79-E81 Push Rod Cover O-ring Upper..... | 10..... | \$4.49 |
| C9459..... | 11132..... | L79-84 Push Rod Cover O-ring Middle..... | 25..... | \$3.92 |
| C9460..... | 11133..... | L79-E81 Push Rod Cover O-ring Lower..... | 5..... | \$3.92 |
| C9711..... | 11118..... | L81-84 Push Rod Cover O-ring Upper..... | 25..... | \$19.93 |
| C9461..... | 11133..... | L79-E81 Push Rod Cover Quad Seal Lower..... | 10..... | \$9.26 |
| C9297..... | 18633-48D..... | 48-84 Rear Tappet Block Gasket .020" Fiber..... | 10..... | \$6.58 |
| C9298..... | 18634-48C..... | 48-84 Front Tappet Block Gasket .020" Fiber..... | 10..... | \$7.95 |
| C9216..... | | 66-78 All Shovel Push Rod Tube Seal Set..... | Kit..... | \$5.86 |
| C9584..... | | L79-E81 All Shovel Push Rod Tube Seal Set..... | Kit..... | \$4.65 |
| C9585..... | | L81-84 All Shovel Push Rod Tube Seal Set..... | Kit..... | \$5.86 |



Gaskets for Harley-Davidson®



Cometic Gasket - An Exclusive NASCAR Performance® Product

Complete • Top End • Rocker Box Kits & Individual Replacement Parts

| Cometic Part # | OEM Part # | Description | Pkg. Qty. | Price |
|---|-------------|--|-----------|---------|
| • Head and Base Gaskets | | | | |
| C9984 | 16770-66X | 66-84 Shovelhead MLS Stock Bore Head Gasket 74" & 80" .040" | 2 | \$44.99 |
| C9985 | | 66-84 Shovelhead MLS 3 5/8 BB Head Gasket .040" | 2 | \$44.99 |
| C9206 | | Shovel Only Base Gasket Std bore .020" Viton FR & RR Pair | 2 | \$23.85 |
| C9207 | | 3 5/8" Shovel Only Base Gasket Std bore .020" Viton 2 Fronts | 2 | \$23.85 |
| C10116 | | 48-84 Pan/Shovel Std. Bore, No Oil Holes, Pair .020" Fiber | 2 | \$19.98 |
| C9987 | | 48-65 Panhead Base Front & Rear .020" Viton | 2 | \$23.85 |
| C10117 | | 48-84 Pan/Shovel 3 5/8" Bore, No Oil Holes, Pair .020" Fiber | 2 | \$19.98 |
| C9988 | | 48-65 Panhead Base 3 5/8" Front & Rear .020" Viton | 2 | \$23.85 |
| C9989 | | 48-65 Panhead Base 3 5/8" 2 Fronts for S&S Cylinders Viton | 2 | \$23.85 |
| C9714 | | 66-84 Shovelhead Stock Bore Head Gasket; .032" Copper | 2 | \$19.82 |
| C9713 | | 66-84 Shovelhead 3 5/8" Copper Head Gasket: .032" | 2 | \$19.82 |
| C9618 | | 66-84 Pan/Shovel 3 5/8" Base Gasket: .031" Fiber | 2 | \$8.01 |
| C9893 | | 66-84 Pan/Shovel 3 13/16" Base Gasket: .020" RC Metal | 2 | \$20.50 |
| C9567 | 16776-48 | 48-84 Pan/Shovel Front Cyl. Std. Bore base Gasket; .031" Fiber | 10 | \$20.90 |
| C9568 | 16777-48 | 48-84 Pan/Shovel Rear Cyl. Std. Bore base Gasket; .031" Fiber | 10 | \$20.90 |
| C9137 | 16770-48MLS | 48-65 Panhead .040" MLS Head Gasket Pair | 2 | \$44.99 |
| • Cam / Gear Housing Gaskets and Seals | | | | |
| C9334F5 | 25225-36C | 41-69 Gear Cover Gasket, AFM60 | 5 | \$55.42 |
| C9302F5 | 25225-70B | 70-84 Cam Cover Gasket, AFM60 | 5 | \$29.58 |
| C9323 | 32591-70 | 70-79 Points Cover Gasket | 10 | \$11.18 |
| C9306 | 32591-80 | 80-84 Points Cover Gasket | 10 | \$11.13 |
| C9350 | 83162-51DL | 70-84 Cam Cover Seal / Double Lip | 5 | \$18.56 |
| C9337 | 32521-36 | 36-64 Timer Base Gasket | 10 | \$5.28 |
| • Intake and Exhaust Gaskets | | | | |
| C9453 | 27060-55 | 55-E78 Manifold to Head O-ring | 10 | \$6.58 |
| C9608 | 27062-78 | L78-84 Intake Seal Manifold to Head Rubber Band | 10 | \$19.77 |
| C9587 | 65834-68X | 66-84 Exhaust Gasket with Fire Ring | 10 | \$32.66 |
| • Oil Pump and Related Gaskets / Seals | | | | |
| C9435 | 1105 | L70-84 Oil Screen Pump Plug O-ring | 10 | \$4.54 |
| C9349 | 26227-58 | 68-84 Oil Pump Seal | 5 | \$11.93 |
| C9715 | 26231-78 | 54-80 Oil Pump Relief Plug Gasket | 10 | \$13.24 |
| C9397 | 26244-37 | 37-59 Oil Pump Body Gasket | 10 | \$8.98 |
| C9393 | 26245-41 | 41-67 Oil Pump Gasket Fiber | 10 | \$8.34 |
| C9391 | 26246-68D | 68-E80 Oil Pump Body Fiber | 10 | \$7.95 |
| C9394 | 26257-50A | L50-67 Oil Pump Cover Fiber | 10 | \$7.95 |
| C9392 | 26258-68D | 68-E80 Oil Pump Cover Gasket Fiber | 10 | \$13.24 |
| C9382 | 26276-80A | L80-84 Oil Pump Cover Gasket Fiber | 10 | \$7.95 |
| C9403 | 62702-52 | 66-E70 Oil Screen Plug Gasket | 10 | \$11.93 |
| C9365 | 63529-57 | 63-84 Oil Line Sleeve Seal | 10 | \$8.98 |
| C9351 | 12026A | 70-84 Motor Main Shaft Seal | 5 | \$14.59 |
| • Generator Gaskets / Seals | | | | |
| C9322 | 30143-30 | 36-57 Gen. Gasket | 10 | \$10.56 |
| C9321F | 30143-58 | 58-69 Gen. Gasket | 5 | \$5.28 |

Evolution Sportster®

Cometic Part #-C9294
Pushrod Tube O-Ring
Upper 1991-03
Replaces: 11190

Cometic Part #-C9481
Umbrella Valve Seal
1991-03
Replaces: 26856-89

Cometic Part #-C9286
Rocker Cover Washer
1987-03
Replaces: 63858-49

Cometic Part #-C9276
Upper Rocker Box
1991-03
Replaces: 17354-89

Cometic Part #-C9280
Lower Rocker Box
1991-02
Replaces: 17353-89A

Cometic Part #-C9283
Center Rocker Box
Replaces: 17358-84A

Cometic Part #-C9865
One Piece Rocker Base
1986-UP
Replaces: 16778-97X & 16779-97X

Cometic Part #-C9836
Viton Valve Stem Seal
1986-02
Replaces: 18001-83A

Cometic Part #-C9290
Intake Manifold to
Head Seal
Replaces: 26995-86B

Cometic Part #-C9688
Std. Bore Head .040" MLS
1200 1986-UP

Cometic Part #-C9689
Std. Bore Head .030" MLS
1200 1986-UP

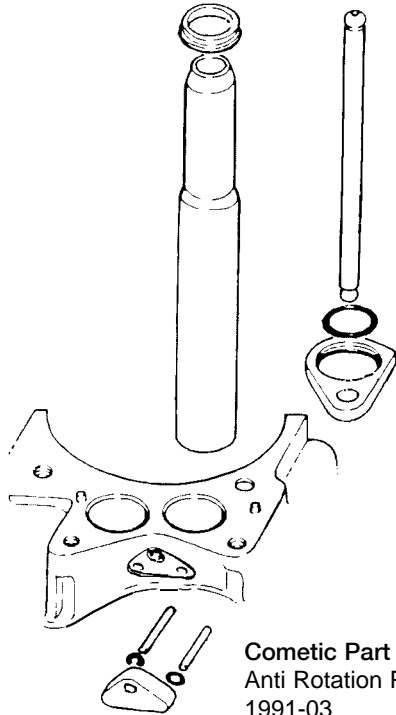

Cometic Part #-C9296
Anti Rotation Pin O-Ring
1991-03
Replaces: 11176

Cometic Part #-C9295
Pushrod Tube O-Ring
Lower 1991-03
Replaces: 17944-89

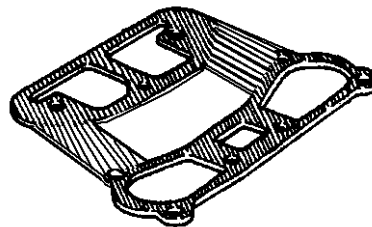
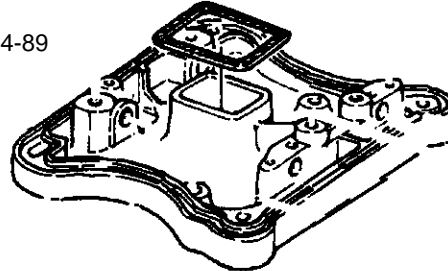
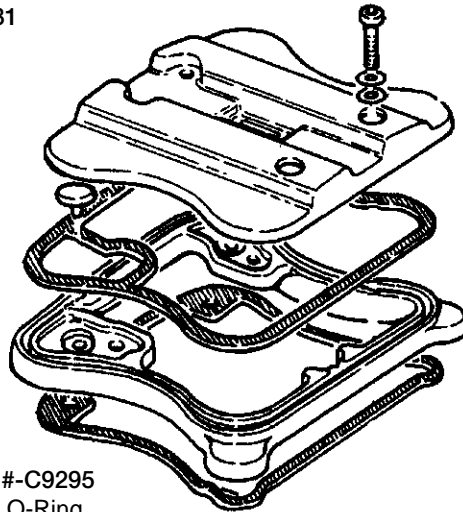

Cometic Part #-C9355
Cam Seal 1986-03
Replaces: 11124-DL



Cometic Part #-C9944F1
Cam Cover 2004-UP
Replaces: 25263-90D AFM
Cometic Part #-C9313F1
Cam Cover 1991-03
Replaces: 25263-90B AFM
Cometic Part #-C9311F1
Cam Cover 1986-90
Replaces: 25263-86 AFM

Cometic Part #-C9719
Race Style Exhaust
Replaces: 65324-83

Cometic Part #-C9288
Std. Exhaust
Replaces: 65324-83

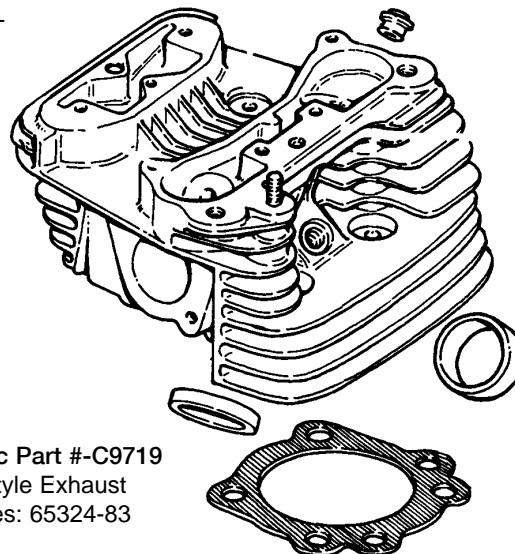



Gaskets for Harley-Davidson®



Cometic Gasket - An Exclusive NASCAR Performance® Product

Complete • Top End • Rocker Box Kits & Individual Replacement Parts

| Cometic Part # | Description | Price |
|---|--|----------|
| EST BUELL FIREBOLT and BLAST | | |
| • Top End and Complete Motor Rebuild Gasket Kits | | |
| C10111 | Buell XB9, XB12, 2003-10 Top End Rebuild Standard Bore..... | \$106.18 |
| C10115 | Buell XB9, XB12, 2003-10 Top End Rebuild 3.570" Bore..... | \$106.18 |
| C9204 | Buell Firebolt Top End Rebuild Kit Std. Bore 04-06..... | \$106.18 |
| C9856 | Buell Firebolt Top End Rebuild Kit Std. Bore 00-03..... | \$106.18 |
| C9857 | Buell Firebolt Complete Motor Rebuild Kit Std. Bore 02-03..... | \$150.76 |
| C9863 | Buell Blast Big Bore Top End Rebuild 3 13/16"..... | \$84.15 |
| C9863-STD | Buell Blast Big Bore Top End Rebuild STD Bore..... | \$84.15 |
| C9864 | Buell Blast Big Bore Complete Motor Kit 3 13/16"..... | \$124.99 |
| C9864-STD | Buell Blast Big Bore Complete Motor Kit STD Bore..... | \$124.99 |
| • Rocker Box Rebuild Kit | | |
| C9213 | Buell XB 9/12 98-02..... | \$47.76 |
| EST EVO SPORTSTER MOTOR GASKET KITS | | |
| • Complete Gasket Kits | | |
| C9754F | 86-90 883 EVO Sportster..... | \$180.86 |
| C9755F | 91-03 883 EVO Sportster..... | \$193.18 |
| C9193 | 04-06 883 EVO Sportster..... | \$216.86 |
| C9191 | 07-16 883 EVO Sportster..... | \$216.86 |
| C9756F | 86-87 1100 EVO Sportster..... | \$150.76 |
| C9757F | 88-90 1200 EVO Sportster..... | \$198.17 |
| C9758F | 91-03 1200 EVO Sportster..... | \$209.53 |
| C9855F | 91-03 1200 EVO Sportster W / .030" Head Gasket..... | \$150.76 |
| C9133 | 91-03 1200 EVO Sportster 3 13/16" Big Bore w/.040" Head Gasket..... | \$150.76 |
| C9124 | 91-03 1200 EVO Sportster 3 13/16" Big Bore W / .030" Head Gasket..... | \$150.76 |
| C9952 | 04-06 1200 EVO Sportster..... | \$150.76 |
| C9953 | 04-06 1200 EVO Sportster W / .030" Head Gasket..... | \$150.76 |
| C9176 | 07-16 1200 EVO Sportster..... | \$216.86 |
| • Top End Gasket Kits | | |
| C9759 | 86-90 883 EVO Sportster..... | \$106.18 |
| C9760 | 91-03 883 EVO Sportster..... | \$106.18 |
| C9194 | 04-06 883 EVO Sportster..... | \$171.43 |
| C9192 | 07-16 883 EVO Sportster..... | \$171.43 |
| C9761 | 86-87 1100 EVO Sportster..... | \$106.18 |
| C9762 | 88-90 1200 EVO Sportster..... | \$106.18 |
| C9907 | 88-90 1200 EVO Sportster W / .030" Head Gasket..... | \$106.18 |
| C9763 | 91-03 1200 EVO Sportster..... | \$106.18 |
| C9854F | 91-03 1200 EVO Sportster W / .030" Head Gasket..... | \$106.18 |
| C9970 | 04-06 1200 EVO Sportster..... | \$106.18 |
| C9971 | 04-06 1200 EVO Sportster W / .030" Head Gasket..... | \$106.18 |
| C9177 | 07-16 1200 EVO Sportster..... | \$106.18 |
| • Big Bore Top End Gasket Kits | | |
| C10096 | 3.570" Top end kit w/.030" MLS Head Gasket 1991-03..... | \$106.18 |
| C10095 | 3.570" Top end kit w/.030" MLS Head Gasket 2004-06..... | \$106.18 |
| C10094 | 3.570" Top end kit w/.030" MLS Head Gasket 2007-Up..... | \$106.18 |
| C10048 | 3.562" Bore; 91-03 EVO Sportster W / .040" MLS Head Gasket..... | \$106.18 |
| C10050 | 3.5/8" Bore; 91-03 EVO Sportster W / .027" MLS Head Gasket..... | \$106.18 |
| C10050-040 | 3.5/8" Bore; 91-03 EVO Sportster W / .040" MLS Head Gasket..... | \$106.18 |
| C9772 | 3 3/4" Bore; 86-90 883 EVO Sportster..... | \$106.18 |
| C9773 | 3 3/4" Bore; 91-UP 883 EVO Sportster..... | \$111.12 |
| C9774 | 3 3/4" Bore; 86-87 1100 EVO Sportster..... | \$106.18 |
| C9775 | 3 3/4" Bore; 88-90 1200 EVO Sportster..... | \$106.18 |
| C9776 | 3 3/4" Bore; 91-03 1200 EVO Sportster..... | \$209.36 |
| C9138 | 3 13/16" Bore; 91-03 1200 EVO Sportster W / .040" MLS Head Gasket..... | \$106.18 |
| C9141 | 3 13/16" Bore; 91-03 1200 EVO Sportster W / .030" MLS Head Gasket..... | \$106.18 |
| C9219 | 3 13/16" Bore; 04-06 1200 EVO Sportster W / .040" MLS Head Gasket..... | \$106.18 |
| C10057 | 3.875" XR1200 08-13, .030" Head & .020" Base Kit..... | \$68.80 |



Gaskets for Harley-Davidson®



Cometic Gasket - An Exclusive NASCAR Performance® Product

Complete • Top End • Rocker Box Kits & Individual Replacement Parts

| Cometic Part # | OEM Part # | Description | Pkg. Qty. | Price |
|--|-------------------------------------|-------------|-----------|---------|
| • Rocker Box Rebuild Gasket Kit | | | | |
| C9764 | 86-90 883, 1100, 1200 EVO Sportster | | | \$47.76 |
| C9765 | 91-03 883, 1200 EVO Sportster | | | \$47.76 |
| C9954 | 04-06 883, 1200 EVO Sportster | | | \$47.76 |
| C9195 | 07-16 All Sportster Models | | | \$47.76 |

EVO SPORTSTER INDIVIDUAL REPLACEMENT GASKETS,SEALS, O-RINGS

• Rocker Cover Gaskets

| | | | | |
|-------|-----------|--|----|---------|
| C9196 | 17362-07 | Outer Rocker Gasket all Sportster Models, 07-16 XL | 2 | \$15.90 |
| C9197 | 17695-07 | Inner Rocker Gasket all Sportster Models, 07-16 XL | 2 | \$4.54 |
| C9198 | 17393-07 | Rocker Breather Seal 07-16 XL | 2 | \$11.36 |
| C9208 | 17353-89B | Outer Rocker Gasket all Sportster Models 04-06 | 2 | \$15.90 |
| C9400 | 611486 | Rocker Cover Washer copper 87-16 | 10 | \$6.58 |
| C9286 | 63858-49 | 87- 05 Rocker Cover Washer Gasket 87-16 | 10 | \$5.86 |
| C9014 | 17353-86A | 87-90 Lower Rocker Cover Gasket rubber | 5 | \$33.84 |
| C9279 | 17353-86 | 86 Lower Rocker Cover cork | 5 | \$35.83 |
| C9280 | 17353-89 | 91-03 Lower Rocker Cover Gasket rubber | 5 | \$25.21 |
| C9010 | 17354-86A | 87-90 Upper Rocker Cover Gasket rubber | 5 | \$33.84 |
| C9275 | 17354-86 | 86 Upper Rocker Cover cork | 5 | \$35.83 |
| C9276 | 17354-89 | 91-03 Upper Rocker Cover Gasket rubber | 5 | \$25.21 |
| C9283 | 17358-84A | 86-06 Center Rocker Cover Gasket rubber | 10 | \$18.56 |
| C9707 | 17358-84 | 86-04 Center Rocker Cover Cork | 5 | \$10.96 |
| C9865 | 16800-84 | 86-04 One piece rocker base gasket .020" Rubber Coated Steel 86-16 | 2 | \$15.38 |
| C9561 | 16778-97X | 86-04 Lower Rckr Cover to Head / Right, .020" Rubber Coated Steel | 5 | \$21.18 |
| C9563 | 16779-97X | 86-04 Lower Rckr Cover to Head / Left, .020" Rubber Coated Steel | 5 | \$25.21 |
| C9285 | 16778-84A | 86-04 Lower Rckr Cover to Head / Right Gasket | 5 | \$10.56 |
| C9284 | 16779-84B | 86-04 Lower Rckr Cover to Head / Left Gasket | 5 | \$17.21 |
| C9481 | 26856-89 | 91-03 Umbrella Valve Seal | 10 | \$10.56 |
| C9224 | | S&S Outer Rocker Gasket w/ Breather Flapper | 4 | \$40.40 |
| C9225 | | S&S Inner Rocker O-Ring Seal | 8 | \$12.67 |
| C9226 | | S&S Rocker Cover Bolt Washer Seal | 24 | \$22.93 |

2004 SPORTSTER ROCKER BOXES ARE TWO PIECE AND DO NOT USE AN UPPER ROCKER RUBBER GASKET

• Head and Base Gaskets

| | | | | |
|--------|-----------|---|-----|---------|
| C10003 | | XR1200 STD Bore MLS head gasket .040" 08-12 | 2 | \$44.99 |
| C10004 | | XR1200 3.812" Bore MLS head gasket .040" 08-12 | 2 | \$44.99 |
| C10057 | | XR1200 08-12 3.875" Big Bore Head .030" & Base .020" Kit 08-12 | Kit | \$68.80 |
| C9205 | | Stock Bore 883 EVO's .040" MLS Design 86-16 | 2 | \$44.99 |
| C9688 | | Stock Bore EVO's 3.570" .030" MLS Design 86-16 | 2 | \$44.99 |
| C9689 | | Stock Bore EVO's 3.570" .040" MLS Design 86-16 | 2 | \$44.99 |
| C9690 | | 3 5/8" Big Bore EVO's .030" MLS Design 86-16 | 2 | \$44.99 |
| C9691 | | 3 5/8" Big Bore EVO's .040" MLS Design 86-16 | 2 | \$44.99 |
| C9694 | | 3 3/4" Big Bore EVO's .030" MLS Design 86-16 | 2 | \$44.99 |
| C9695 | | 3 3/4" Big Bore EVO's .040" MLS Design 86-16 | 2 | \$44.99 |
| C9692 | | 3 13/16" Big Bore EVO's .030" MLS Design 86-16 | 2 | \$44.99 |
| C9693 | | 3 13/16" Big Bore EVO's .040" MLS Design 86-16 | 2 | \$44.99 |
| C9287 | 26432-76A | 86-05 Cylinder to Head Dowel O-ring | 10 | \$11.93 |
| C9214 | 16774-86E | 06-UP Cylinder Base Gasket, All Buell & Sportster .020" Embossed Rubber Coated Steel | 2 | \$23.85 |
| C9553 | 16774-96 | 86-05 Cylinder Base Gasket, .020" Rubber Coated Steel | 2 | \$23.85 |
| C9008 | 16774-86D | 86-05 Cylinder Base Gasket, .020" Fiber | 2 | \$4.49 |
| C9836 | | 86-99 Valve Guide Seal Viton | 25 | \$73.42 |
| C9153 | 18094-02 | 02-UP Valve Stem Oil Seal Hat Style All Models Viton | 25 | \$95.73 |



Gaskets for Harley-Davidson®



Cometic Gasket - An Exclusive NASCAR Performance® Product

Complete • Top End • Rocker Box Kits & Individual Replacement Parts

| Cometic Part # | OEM Part # | Description | Pkg. Qty. | Price |
|---|------------|---|-----------|----------|
| • Pushrod O-Ring Kit | | | | |
| C10133 | | 04-16 Sportster Pushrod O-ring Kit | KIT | \$14.70 |
| C9143 | | 91-03 Sportster Pushrod O-ring Kit | KIT | \$13.90 |
| • Pushrod and Tappet Block Gaskets and O-rings | | | | |
| C9955 | 17976 | 04-16 Tappet block gasket | 2 | \$15.79 |
| C9956 | 11377 | 04-16 Lower pushrod tube O-ring | 25 | \$63.89 |
| C9459 | 11132 | 86-90 Pushrod Tube O-ring Middle | 25 | \$3.92 |
| C9293 | 11145 | 86-90 Pushrod Tube O-ring Lower | 25 | \$7.95 |
| C9292 | 111157 | 86-90 Pushrod Tube O-ring Upper | 25 | \$20.33 |
| C9448 | 11110 | 86-90 Tappet Screw O-ring | 10 | \$5.28 |
| C9443 | 11167 | 86-90 Tappet Block O-ring Upper | 25 | \$10.56 |
| C9444 | 11168 | 86-90 Tappet Block O-ring Lower | 10 | \$10.56 |
| C9294 | 11190 | 91-16 Pushrod Tube O-ring Upper | 10 | \$10.17 |
| C9295 | 17944-89 | 91-99 Pushrod Tube O-ring Lower | 10 | \$17.66 |
| C9296 | 11176 | 91-99 Tappet Pin Cover O-ring - Anti Rotation Pin | 10 | \$1.03 |
| • Intake and Exhaust Gaskets | | | | |
| C9290 | 26995-86A | 86-16 Intake Manifold to Head / Seal | 10 | \$19.87 |
| C9088 | 27002-89 | 84-04 Intake Seal to Carb | 1 | \$6.58 |
| C9719 | 65324-83 | 84-16 Exhaust Port Gasket Race Style | 10 | \$40.42 |
| C9288 | 65324-83A | 84-16 Exhaust Port Gasket Tapered Style | 10 | \$47.81 |
| C9540 | | 84-16 All Models Exhaust Extreme Performance | 10 | \$74.56 |
| C9223 | | S&S Big Bore Manifold to Head Seal | 4 | \$18.56 |
| • Cam Cover Gaskets | | | | |
| C9355 | 11124-DL | 86-99 Points Cover Seal Double Lip | 5 | \$10.28 |
| C9306F | 32591-80 | 86-99 Points Cover Gasket | 10 | \$11.13 |
| C9311F5 | 25263-86 | 86-90 Cam Cover Gasket | 10 | \$67.40 |
| C9313F5 | 25263-90B | 91-03 Cam Cover Gasket | 5 | \$60.65 |
| C9944F5 | 25263-90D | 04-16 Cam Cover Gasket | 5 | \$32.19 |
| C10049F1 | 25262-90D | 91-03 Sporty Cam Cover Gasket .060" AFM | 1 | \$12.16 |
| C10049F5 | 25262-90D | 91-03 Sporty Cam Cover Gasket .060" AFM | 5 | \$60.65 |
| C10029F1 | 25279-08 | 08-12 XR1200 Cam Cover Gasket | 1 | \$7.56 |
| C10029F5 | 25279-08 | 08-12 XR1200 Cam Cover Gasket | 5 | \$32.19 |
| • Primary Cover Gaskets ,Seals | | | | |
| C9125 | | 04-16 Sportster Complete Primary Rebuild | Kit | \$30.38 |
| C9211 | | 91-03 Sportster Complete Primary Rebuild | Kit | \$40.88 |
| C9210 | | 86-90 Sportster Complete Primary Rebuild | Kit | \$40.88 |
| C9943F5 | 34955-04 | 04-16 Primary Cover Gasket | 5 | \$105.16 |
| C9957 | 34986-04 | 04 -16 Chain Inspection Cover Gasket .060" AFM | 5 | \$23.17 |
| C9435 | 11105 | 04 -16 Primary drain plug O-ring | 10 | \$4.54 |
| C9436 | 11171 | 86-16 Primary Inspection Cover Screw O-ring | 10 | \$6.58 |
| C9447 | 11179 | 88-99 Clutch Cable O-ring | 25 | \$3.92 |
| C9434 | 11187 | 91-93 Clutch Inspection Cover O-ring | 10 | \$7.95 |
| C9439 | 11188 | 91-99 Inspection Cover O-ring | 10 | \$7.95 |
| C9220 | 25463-94A | 94-UP Clutch Cover O-ring | 5 | \$35.43 |
| C9363 | 31433-84A | 91-93 Sealing Washer | 5 | \$6.42 |
| C9401 | 34624-77 | 77-90 Footpeg Stud Gasket | 10 | \$12.83 |
| C9310F5 | 34955-75 | 77-90 Primary Cover Gasket, AFM60 | 5 | \$105.16 |
| C9314F5 | 34955-89A | 91-03 Primary Cover Gasket, AFM60 | 5 | \$105.16 |
| C9943F5 | 34955-04 | 04-16 Sportster Primary Cover Gasket, AFM60 | 5 | \$105.16 |
| C9354 | 37101-84 | 86-UP Shifter Shaft Seal | 1 | \$2.61 |
| C9353 | 35151-74 | 86-99 Motor Sprocket Shaft Seal | 5 | \$21.58 |
| C9632 | 12068 | 04-16 Motor Sprocket Shaft Seal | 5 | \$30.95 |
| C9667 | 11289 | 04-16 Crank Position Sensor O-ring | 25 | \$3.92 |
| C10104 | 37101-06 | 06-14 Shift Shaft Seal All XL | 1 | \$2.61 |
| C10104F5 | 37101-06 | 06-14 Shift Shaft Seal All XL | 5 | \$12.23 |

Complete • Top End • Rocker Box Kits & Individual Replacement Parts

| Cometic Part # | OEM Part # | Description | Pkg. Qty. | Price |
|--|----------------|---|-----------|---------|
| • Oil Pump and Related Gaskets,Seals, and O-rings | | | | |
| C9376..... | 12036A | 86-90 Oil Pump Seal metal..... | 5 | \$7.66 |
| C9449..... | 26433-77 | 86-90 Oil Pump Check Valve O-ring | 10 | \$9.26 |
| C9439..... | 26434-76A..... | 86-90 Oil Pump O-ring..... | 10 | \$7.95 |
| C9437..... | 26434-91 | 91-16 Oil Pump Cover O-ring | 10 | \$2.95 |
| C9399F..... | 26495-75 | 86-90 Oil Pump Gasket | 10 | \$9.26 |
| C9315F..... | 26495-89B..... | 91-16 Oil Pump Gasket | 10 | \$7.95 |
| C9961..... | 11120..... | 04-16 Oil dipstick O-ring | 5 | \$3.92 |
| C9962..... | | 04-16 Oil jet assembly gasket..... | 6 | \$10.62 |
| • Starter and Transmission Gaskets,Seals, and O-rings | | | | |
| C9312F..... | 31488-81B..... | 86-UP Starter Gasket..... | 10 | \$7.66 |
| C9362..... | 12030..... | 91-06 Main Drive Gear Seal | 5 | \$10.56 |
| C9356..... | 12049-DL..... | 86-90 Transmission M/S Seal | 5 | \$10.28 |
| C9359..... | 12050..... | 91-94 Transmission M/S Seal | 1 | \$5.28 |
| C9262..... | 12067A | 95-04 Main Drive Gear Seal | 1 | \$6.58 |
| C9361..... | 11165..... | 91-04 Main Shaft Quad Seal 5th Gear | 10 | \$13.24 |
| C9460..... | 11113..... | 05-16 Main Shaft O-ring 5th Gear | 5 | \$3.92 |
| C9215..... | 12074..... | 07-16 Main Shaft Seal | 1 | \$10.11 |

Iron Sportster®

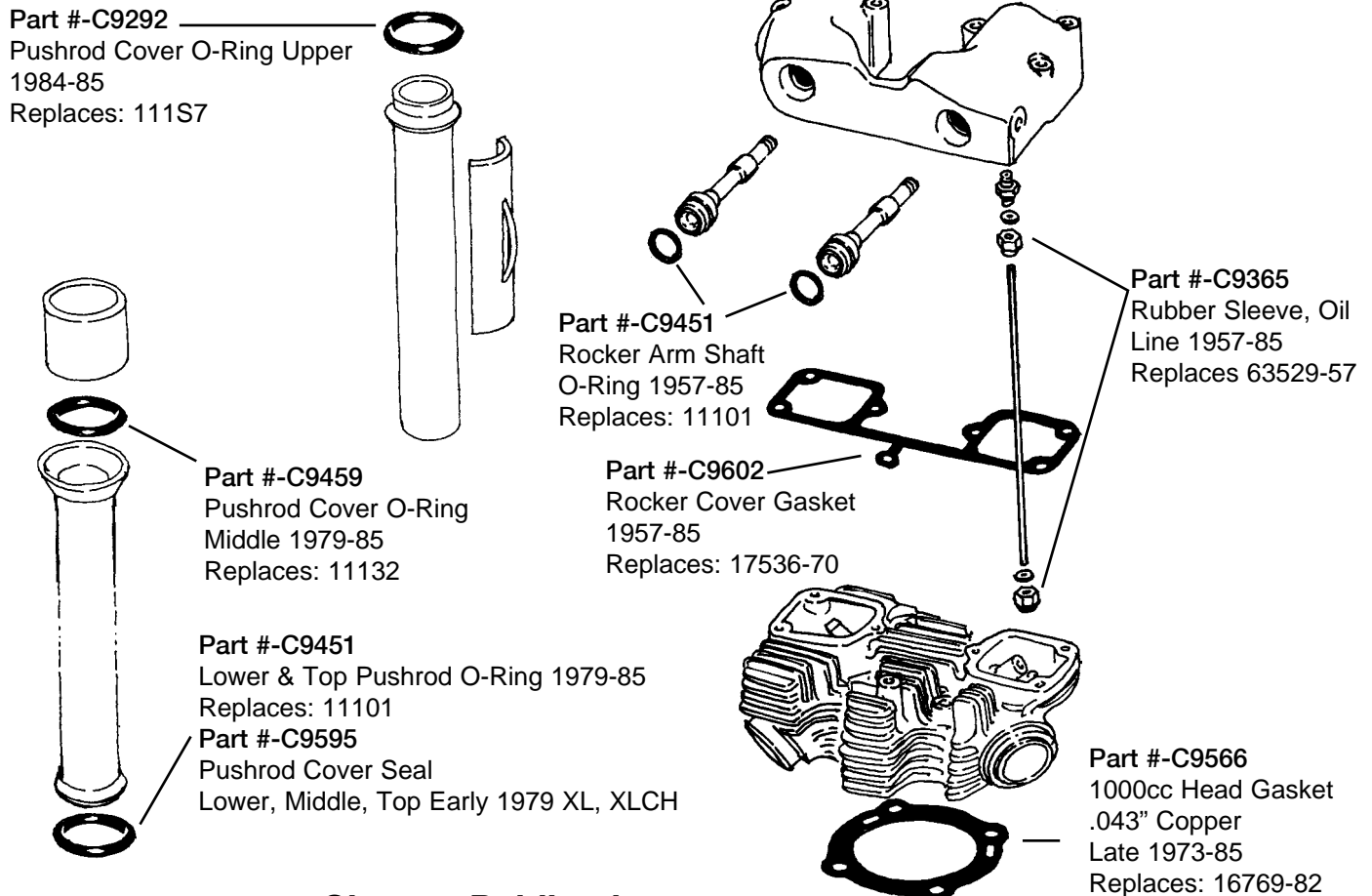

Illustrations courtesy: **Clymer® Publications** Clymer.com



Gaskets for Harley-Davidson®



Cometic Gasket - An Exclusive NASCAR Performance® Product

Complete • Top End • Rocker Box Kits & Individual Replacement Parts

| Cometic Part # | OEM Part # | Description | Pkg. Qty. | Price |
|----------------|------------|-------------|-----------|-------|
|----------------|------------|-------------|-----------|-------|

STANDARD MOTOR KITS FOR 900/1000 SPORTSTER

• Complete Gasket Kits for 900/1000 Sportster

| | | | | |
|--------|-----------|---|--|----------|
| C9045F | 17026-71 | 1957-71 900 Sportster XL, XLH, XLCH | | \$137.64 |
| C9047F | 17026-72 | 1972-E73 1000 Sportster XLH, XLCH | | \$117.54 |
| C9049F | 17026-73L | 1973-76 1000 Sportster XLH, XLCH | | \$115.45 |
| C9051F | 17026-79 | 1977-85 1000 Sportster XLH, XLCH, XLS Hi-Compression | | \$131.99 |
| C9117F | 17026-82 | 1982-85 1000 Sportster XLH, XL, XLS Low Compression, .063" Head Gaskets | | \$122.99 |

Kit contains .032" copper head gaskets and all of the necessary gaskets, seals and o-rings to rebuild the motor.
Base Gaskets are .031"

• Top End Gasket Kits for 900/1000 Sportster

| | | | | |
|-------|------------|---|--|---------|
| C9102 | 17030-57 | 1957-71 900 Sportster XL, XLH, XLCH | | \$54.68 |
| C9103 | 17030-72 | 1972-E73 1000 Sportster XLH, XLCH | | \$54.68 |
| C9104 | 17030-72AL | 1973-76 1000 Sportster XLH, XLCH | | \$54.68 |
| C9052 | 17030-72B | 1977-85 1000 Sportster XLH, XLCH, XLS Hi-Compression | | \$54.68 |
| C9116 | 17030-82 | 1982-85 1000 Sportster XLH, XL, XLS Low Compression, .063" Head Gaskets | | \$54.68 |

Kit contains all of the necessary gaskets, seals and o-rings to rebuild the motor from the cylinder base up.
Head Gaskets are .032" copper except where noted and Base Gaskets are .031"

1957-85 XL IRONHEAD SPORTSTER INDIVIDUAL REPLACEMENT GASKETS,SEALS, O-RINGS

• Rocker Cover Gaskets

| | | | | |
|-------|-------|-------------------------------|----|--------|
| C9400 | 6114 | 86 Rocker Cover Washer copper | 10 | \$6.58 |
| C9451 | 11101 | 57-85 Rocker Arm Shaft O-ring | 10 | \$4.49 |

• Rocker Cover Gaskets,Seals,and O-rings

| | | | | |
|-------|----------|--------------------------------------|----|--------|
| C9448 | 11110 | 83-85 XR1000 Rocker Shaft O-ring | 10 | \$5.28 |
| C9529 | 11115 | 83-85 XR1000 Rocker Arm Shaft O-ring | 10 | \$7.95 |
| C9602 | 17536-70 | 57-85 Rocker Cover Gasket | 10 | \$9.94 |
| C9365 | 63529-57 | 57-85 Rubber Sleeve, Oil Line | 10 | \$8.98 |

• Head and Base Gaskets

| | | | | |
|-------|-----------|--|----|----------|
| C9698 | 16769-72A | 72-E73 1000cc Head Gasket , .020" Copper | 10 | \$116.79 |
| C9565 | 16769-73 | L73-85 1000cc Head Gasket , .032" Copper | 10 | \$116.79 |
| C9566 | 16769-82 | L73-85 1000cc Head Gasket , .043" Copper | 10 | \$83.59 |
| C9699 | 16774-57 | 57-71 900cc Cylinder Base Gasket, .012" Fiber | 10 | \$41.50 |
| C9603 | 16774-72 | 72-85 1000cc Cylinder Base Gasket, .031" Fiber | 10 | \$21.10 |

• Pushrod and Tappet Block Gaskets, O-rings

| | | | | |
|--------|-----------|--|-----|---------|
| C10068 | | 57-84 All Iron Sportsters Pushrod seal set | Kit | \$10.08 |
| C9459 | 11132 | 79-85 Pushrod Cover O-ring (4) middle | 25 | \$3.92 |
| C9292 | 11157 | 84-85 Pushrod Cover O-ring (4) upper | 25 | \$20.33 |
| C9369 | 12023 | 83-85 XR 1000 Pushrod Cover Seal | 5 | \$14.59 |
| C9598 | 17955-36 | 57-E79 Pushrod Cover Seal / cork | 25 | \$8.75 |
| C9408 | 17955-36A | 57-E79 Pushrod Cover Seal / rubber | 100 | \$61.10 |

• Intake and Exhaust Gaskets

| | | | | |
|-------|----------|--------------------------------------|----|---------|
| C9608 | 27062-78 | 79-85 Intake Manifold to Head O-ring | 10 | \$19.77 |
|-------|----------|--------------------------------------|----|---------|

• Cam and Timer Compartment Gaskets

| | | | | |
|---------|-----------|---|----|---------|
| C9355 | 11124DL | 71-85 Timer Compartment Seal / double lip | 5 | \$10.28 |
| C9325 | 32522-37 | 57-64 XL, XLH Timer Base Gasket | 10 | \$10.56 |
| C9316F5 | 25224-52A | 57-81 Cam cover Gasket, XR750 | 5 | \$70.47 |
| C9332 | 25263-81 | 82-85 Cam Cover Gasket | 10 | \$87.36 |
| C9323 | 32591-70 | 71-78 Point Cover Gasket | 10 | \$11.18 |
| C9306 | 32591-80 | 80-85 Ignition Cover Gasket | 10 | \$11.13 |



Gaskets for Harley-Davidson®



Cometic Gasket - An Exclusive NASCAR Performance® Product

Complete • Top End • Rocker Box Kits & Individual Replacement Parts

| Cometic Part # | OEM Part # | Description | Pkg. Qty. | Price |
|--|------------|--|-----------|----------|
| • Charging and Starting Gaskets | | | | |
| C9433 | 11116 | 81-85 Starter Housing O-ring | 25 | \$6.58 |
| C9701 | 31461-70 | 70-E79 Starter hole cover plate Gasket | 10 | \$25.38 |
| C9324 | 31471-67A | 67-80 Starter Housing Gasket | 10 | \$27.82 |
| C9333 | 31488-77 | 67-80 Starter Housing Mount Gasket | 10 | \$5.28 |
| C9312 | 31488-81 | 81-85 Starter Motor Gasket | 10 | \$7.66 |
| C9702 | 60645-65 | 67-80 Solenoid Gasket | 10 | \$7.84 |
| C9369 | 12023 | 68-69 XLCH Magneto Seal | 5 | \$14.59 |
| C9327 | 29550-55 | 58-69 XLCH Magneto Cover Gasket | 10 | \$13.24 |
| C9374 | 29603-48 | 58-E65 Magneto Seal | 10 | \$11.93 |
| C9321 | 30143-58 | 58-E84 Generator Gasket | 5 | \$5.28 |
| • Oil System Gaskets, O-rings and Seals | | | | |
| C9376 | 12036A | 77-78 / 83-85 Oil Pump Outer Plate Seal | 5 | \$7.66 |
| C9404 | 24978-57 | 57-76 Oil Strainer Gasket | 10 | \$6.42 |
| C9349 | 26227-58 | L58-76 Oil Pump Oil Seal | 5 | \$11.93 |
| C9390 | 26256-52 | 57-76 Oil Pump Gasket | 10 | \$9.26 |
| C9385 | 26258-52 | 57-E62, 72-76 Oil Pump Outer Cover Gasket | 10 | \$11.93 |
| C9389 | 26258-62 | L62-71 Oil Pump Outer Cover Gasket | 10 | \$11.93 |
| C9388 | 26259-52 | 57-E62, 72-76 Oil Pump Inner Cover Gasket | 10 | \$13.24 |
| C9386 | 26259-62 | L62-71 Oil Pump Inner Cover Gasket | 10 | \$11.93 |
| C9287 | 26432-76A | 77-85 Oil Pump Body O-ring | 10 | \$11.93 |
| C9449 | 26433-77 | 77-85 Check Valve Oil Pump O-ring | 10 | \$9.26 |
| C9445 | 26434-76A | 77-85 Oil Pump Cover O-ring | 10 | \$6.58 |
| C9399 | 26495-75 | 77-85 Oil Pump Gasket | 10 | \$9.26 |
| C9286 | 63858-49 | 71-85 Oil Level Screw Gasket | 10 | \$5.86 |
| • Primary, Clutch, and Transmission Gaskets, Seals, and O-rings | | | | |
| C9446 | 11139 | L78-85 Primary Filler Cap O-ring | 10 | \$6.58 |
| C9317F5 | 34952-52 | XR750, 58-69 XLCH Primary Cover Gasket AFM .060" | 5 | \$93.59 |
| C9318F5 | 34955-67 | 67-76 XLH, 70-76 XLCH Primary Cover Gasket AFM .060" | 5 | \$117.26 |
| C9703 | 34955-67A | 67-76 XLH, 70-76 XLCH Primary Cover Gasket .031" | 5 | \$134.92 |
| C9326 | 60567-36 | 36-64 FL, FLH 58-69 XLCH Inspection/Chain Cover .125" Cork | 10 | \$39.52 |
| C9326F | 60567-36 | 36-64 FL, FLH 58-69 XLCH Inspection/Chain Cover .125" Cork | 5 | \$20.55 |
| C9326F1 | 60567-36 | 36-64 FL, FLH 58-69 XLCH Inspection/Chain Cover .060" AFM | 1 | \$3.97 |
| C9326F5 | 60567-36 | 36-64 FL, FLH 58-69 XLCH Inspection/Chain Cover .060" AFM | 5 | \$20.55 |
| C9458 | 11103 | L57-66 XLH, 57-69 XLCH Clutch Gear O-ring | 10 | \$3.92 |
| C9310F5 | 34955-75 | 77-90 Sportster Primary Cover Gasket AFM .060" | 5 | \$105.16 |
| • Primary, Clutch, and Transmission Gaskets, Seals, and O-rings | | | | |
| C9455 | 11119 | 67-70 XLH, 70 XLCH Clutch Gear O-ring | 25 | \$5.28 |
| C9367 | 12021 | 67-70 XLH, 70 XLCH Clutch Gear Oil Seal | 5 | \$14.59 |
| C9364 | 37339-53 | 57-70 Release Rod Oil Seal | 10 | \$8.98 |
| C9368 | 37531-56B | 57-66 XLH, 57-69 XLCH Clutch Gear Seal | 5 | \$10.28 |
| C9371 | 37740-57 | L57-66 XLH, 57-69 XLCH Clutch Shell Seal | 5 | \$19.87 |
| C9513 | 37741-67 | 67-70 XLH, 70 XLCH Clutch Shell Seal | 5 | \$26.51 |
| C9319 | 37762-52 | 57-70 Clutch Cover Gasket | 10 | \$44.63 |
| C9374 | 33076-37 | 57-79 Kicker Shaft Seal | 10 | \$11.93 |
| C9370 | 34035-52 | 57-85 Shifter Shaft Seal | 5 | \$10.56 |
| C9401 | 34624-77 | 77-85 Left Footrest Stud Boss Gasket | 10 | \$12.83 |
| C9356 | 12049DL | L84-85 Transmission Mainshaft Seal | 5 | \$10.28 |
| C9366 | 35151-52A | 57-E84 Trans Mainshaft Seal, 57-E74 Sprocket Shaft | 5 | \$13.24 |
| C9353 | 35151-74 | L84-85 Trans Mainshaft Seal, L74-85 Motor Sprocket Shaft | 5 | \$21.58 |

Rotax 600 Gaskets

| Part # | Description | Price |
|--------|--|---------|
| C9500 | Head and Base, Long Stroke, 3.860" Bore Supplied with .010 and .020 Copper Base Gasket (4.120" Sleeve Dia.) | \$41.23 |
| C9501 | Head and Base, Long Stroke, 3.908" Bore Supplied with .010 and .020 Copper Base Gasket (4.120" Sleeve Dia.) | \$41.23 |
| C9504 | .005 Copper Base Gasket | \$12.16 |
| C9502 | .010 Copper Base Gasket | \$12.16 |
| C9505 | .016 Copper Base Gasket | \$12.16 |
| C9503 | .020 Copper Base Gasket | \$12.16 |
| C9589 | Ignition Cover Gasket | \$10.56 |
| C9590 | Clutch Cover Gasket | \$10.56 |

Rotax 250 Gaskets

| Part # | Description | Price |
|--------|--------------------------------|---------|
| C9591 | Center Case Gasket | \$13.24 |
| C9592 | Clutch Cover Gasket | \$14.59 |
| C9593 | Intake Gasket | \$5.50 |
| C9594 | Base Gasket .020" Kevlar Fiber | \$7.66 |

Polaris Victory V92C Head & Base Gaskets

| Part # | Description | Price |
|--------|-------------------------------------|----------|
| C8652 | .97mm Head Gasket (1 Pair) / 754cc | \$182.22 |
| C8653 | .101mm Head Gasket (1 Pair) / 817cc | \$175.21 |

Cometic MLS Head Gasket Instructions for Harley Davidson Evolution & Twin Cam applications

NOTE: DO NOT USE THE CYLINDER HEAD ALIGNMENT DOWEL O-RING WHEN USING AN MLS GASKET.

NOTE: COMETIC GASKET RECOMMENDS THE HEAD BOLTS BE SET AT A FINAL TORQUE OF 42FT-LBS.

1. Check all gasket surfaces for flatness and imperfections, an excessively rough finish may cause gasket failure. A 50RA surface is recommended.
2. Check all hardware for defects, clean all threads and lubricate with light machine oil. Including the underside flange of the head bolts. (Wipe away any excess.)
3. There are two short and two long head bolts. The short go on the spark plug side while the long go on the pushrod side.
4. Before installing the head, place the head gasket on the cylinder and locate the gasket using the cylinder head alignment dowels (NOTE: The gasket is embossed around the dowel area and the dowel holes are smaller. Do not use dowel alignment o-rings with an MLS gasket.)
5. Once the gasket is located in place make sure the gasket fits your bore. The gasket should not hang in the bore or combustion chamber in any area.
6. If using a head or cylinder other than stock, check brass rivet location to ensure the rivet does not interfere with the sealing surface in any way. Some aftermarket castings are substantially larger than stock castings and may interfere. Simply remove the brass rivets, "side cutters work well".
7. Once proper fitment is established proceed with head installation and torque. (NOTE: See illustration for sequence.)
8. Alternately snug all the head bolts finger tight.
9. In sequence tighten all head bolts to 9 ft-lbs. Then in sequence tighten all head bolts to 14 ft-lbs. Again in sequence tighten all head bolts to 22 ft-lbs. Then in sequence tighten all head bolts to 35 ft-lbs and finally torque all head bolts to a final torque of 42ft-lbs in sequence.

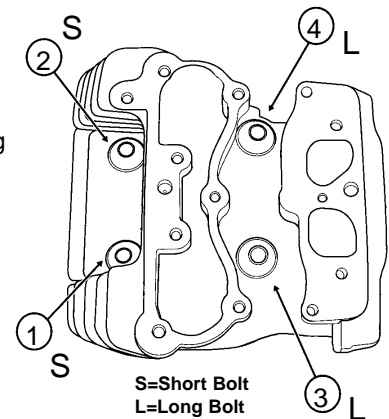

Note: Failure to comply with any or all of these instructions may result in premature failure of the head and or base gasket.

Note: All Panhead, Shovelhead & Iron Sportster models use factory specs when using an MLS head gasket.



V-Twin Hi-Performance Big Bore Display Board Complete with Gaskets, Seals & O-Rings

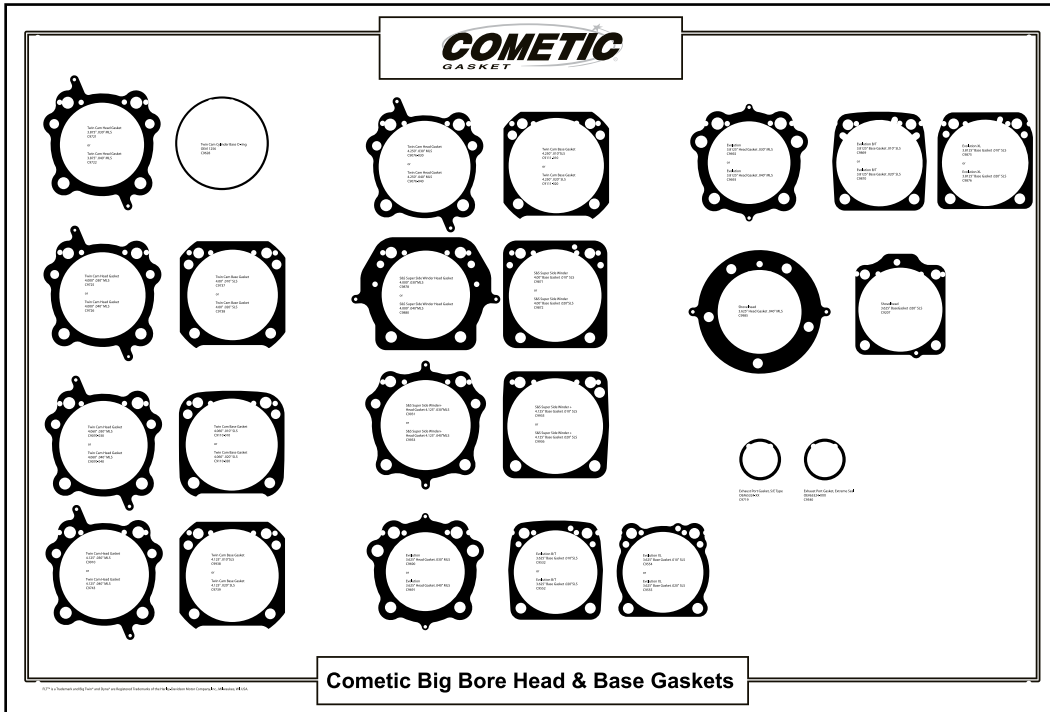

- Sold complete with all Gaskets, Seals & O-Rings and the necessary clamshells, display hooks and xmas treeclips for mounting

- Both Cometic and OE part numbers are printed on boards for easy clarification of parts

- 3 color design, boards measures 48"W x 32"H and are manufactured from 20 mil flexible vinyl and mount easily on 1/8" or 1/4" pegboard

| Part# | Description | List |
|------------|--------------------|------------|
| C9235F-Gas | Gaskets Only | \$1,488.10 |
| C9235F | Display Board Only | \$98.28 |

| Cometic # | OE# | Qty | Description | List |
|----------------------------------|-------|-----|------------------------------|---------|
| Twin Cam | | | | |
| C9721 | | 2 | Head Gasket 3.875" .030" MLS | \$44.99 |
| C9722 | | 2 | Head Gasket 3.875" .040" MLS | \$44.99 |
| C9628 | 11256 | 10 | Cylinder Base O-Ring | \$16.64 |
| C9725 | | 2 | Head Gasket 4.000" .030" MLS | \$44.99 |
| C9726 | | 2 | Head Gasket 4.000" .040" MLS | \$44.99 |
| C9937 | | 2 | Base Gasket 4.00" .010" SLS | \$21.12 |
| C9738 | | 2 | Base Gasket 4.00" .020" SLS | \$23.85 |
| C9070-030 | | 2 | Head Gasket 4.060" .030" MLS | \$44.99 |
| C9070-040 | | 2 | Head Gasket 4.060" .040" MLS | \$44.99 |
| C9110-010 | | 2 | Base Gasket 4.060" .010" SLS | \$23.85 |
| C9110-020 | | 2 | Base Gasket 4.060" .020" SLS | \$23.85 |
| C9910 | | 2 | Head Gasket 4.125" .030" MLS | \$44.99 |
| C9743 | | 2 | Head Gasket 4.125" .040" MLS | \$44.99 |
| C9938 | | 2 | Base Gasket 4.125" .010" SLS | \$23.85 |
| C9739 | | 2 | Base Gasket 4.125" .020" SLS | \$23.85 |
| C9076-030 | | 2 | Head Gasket 4.250" .030" MLS | \$44.99 |
| C9076-040 | | 2 | Head Gasket 4.250" .040" MLS | \$44.99 |
| C9111-010 | | 2 | Base Gasket 4.250" .010" SLS | \$23.85 |
| C9111-020 | | 2 | Base Gasket 4.250" .020" SLS | \$23.85 |
| S&S Super Side Winder | | | | |
| C9878 | | 2 | Head Gasket 4.000" .030" MLS | \$44.99 |
| C9880 | | 2 | Head Gasket 4.000" .040" MLS | \$44.99 |
| C9871 | | 2 | Base Gasket 4.00" .010" SLS | \$23.85 |
| C9872 | | 2 | Base Gasket 4.00" .020" SLS | \$23.85 |

| Cometic # | OE# | Qty | Description | List |
|------------------------------------|-----------|-----|-----------------------------------|---------|
| S&S Super Side Winder + | | | | |
| C9931 | | 2 | Head Gasket 4.125" .030" MLS | \$44.99 |
| C9933 | | 2 | Head Gasket 4.125" .040" MLS | \$44.99 |
| C9935 | | 2 | Base Gasket 4.125" .010" SLS | \$23.85 |
| C9936 | | 2 | Base Gasket 4.125" .020" SLS | \$23.85 |
| Evolution | | | | |
| C9690 | | 2 | Head Gasket 3.625" .030" MLS | \$44.99 |
| C9691 | | 2 | Head Gasket 3.625" .040" MLS | \$44.99 |
| C9532 | | 2 | B/T Base Gasket 3.625" .010" SLS | \$23.85 |
| C9552 | | 2 | B/T Base Gasket 3.625" .020" SLS | \$23.85 |
| C9554 | | 2 | XL Base Gasket 3.625" .010" SLS | \$23.85 |
| C9555 | | 2 | XL Base Gasket 3.625" .020" SLS | \$23.85 |
| C9692 | | 2 | Head Gasket 3.8125" .030" MLS | \$44.99 |
| C9693 | | 2 | Head Gasket 3.8125" .040" MLS | \$44.99 |
| C9869 | | 2 | Base Gasket/B/T 3.8125" .010" SLS | \$23.85 |
| C9870 | | 2 | Base Gasket B/T 3.8125" .020" SLS | \$23.85 |
| C9875 | | 2 | XL Base Gasket 3.8125" .010" SLS | \$23.85 |
| C9876 | | 2 | XL Base Gasket 3.8125" .020" SLS | \$23.85 |
| Shovelhead | | | | |
| C9985 | | 2 | Head Gasket 3.625" .040" MLS | \$44.99 |
| C9207 | | 2 | Base Gasket 3.625" .020" SLS | \$23.85 |
| Misc. | | | | |
| C9719 | 65324-XX | 10 | Exh. Port Gasket, S/E type | \$40.42 |
| C9540 | 65324-XXX | 10 | Exh. Port Gasket, Xtreme Seal | \$74.56 |



Twin Cam 96

Display Board Complete with Gaskets, Seals & O-Rings

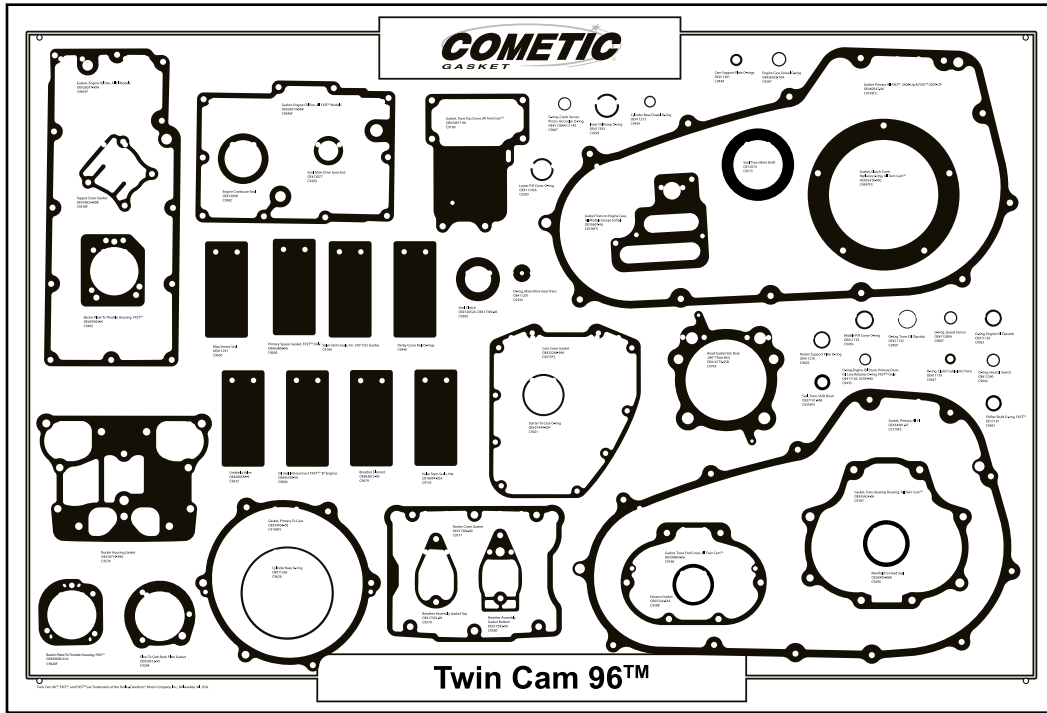

- Sold complete with all Gaskets, Seals & O-Rings and the necessary clamshells, display hooks and xmas treeclips for mounting

- Both Cometic and OE part numbers are printed on boards for easy clarification of parts

- 3 color design, boards measures 48"W x 32"H and are manufactured from 20 mil flexible vinyl and mount easily on 1/8" or 1/4" pegboard

Part#
C9234F-Gas
C9234F

Description
Gaskets Only
Display Board Only

List
\$1762.51
\$98.28

| Cometic # | OE# | Qty | Description | List | Cometic # | OE# | Qty | Description | List |
|-----------|------------|-----|--|---------|-----------|------------|-----|---|----------|
| C9435 | 11105 | 10 | O-ring, primary drain | \$4.54 | C9997F5 | .25416-99C | 5 | Gasket, Clutch cover replces | \$26.80 |
| C9961 | 11120 | 5 | O-ring, engine oil dipstick | \$3.92 | | | | O-ring, All Twin Cam | |
| C9459 | 11132 | 25 | O-ring, middle pushrod cvr | \$3.92 | C9646F | .26072-99A | 10 | Gasket, engine oil pan, | |
| C9459 | 11132 | 25 | O-ring, transmission oil dipstick | \$3.92 | | | | All FXD models | \$92.33 |
| C9447 | 11179 | 25 | O-ring, clutch cable into transmission | \$3.92 | C9647F | .26077-99A | 10 | Gasket, engine oil pan, All FL models | \$92.33 |
| C9661 | 11191 | 25 | O-ring, shifter shaft, FXST | \$4.32 | C9287 | .26432-76A | 10 | O-ring, engine case dowel | \$11.93 |
| C9434 | 11201 | 10 | O-ring, main drive gear transmission | \$7.95 | C9633 | .26858-99 | 10 | Umbrella valve | \$39.18 |
| C9628 | 11256 | 10 | O-ring, cylinder base | \$16.64 | C9290 | .26995-86B | 10 | Seal, manifold to head | \$19.97 |
| C9629 | 11270 | 10 | O-ring, rocker support plate | \$4.02 | C9201 | .27444-00Y | 5 | O-ring, starter to case | \$14.20 |
| C9435 | 11273 | 10 | O-ring cylinder base dowel | \$4.54 | C9304 | .29313-95 | 10 | Gasket, filter to carb backing plate, | \$15.91 |
| C9642 | 11290 | 10 | O-ring, neutral switch | \$11.98 | | | | .060" AFM | |
| C9630 | 11291 | 10 | Map sensor seal | \$15.95 | C9492 | .29583-01A | 10 | Gasket, backing plate to throttle | \$24.44 |
| C9686 | 11292 | 10 | O-ring carb backing plate | \$4.32 | | | | housing, .060" AFM, FXST only | |
| C9294 | 11293 | 10 | O-ring upper pushrod cover | \$10.17 | C9626F | .29583-01A | 10 | Gasket, backing plate to throttle | \$16.98 |
| C9294 | 11293 | 10 | O-ring, inner oil pump | \$10.17 | | | | housing, .060" AFM, FXD only | |
| C9449 | 11301 | 10 | O-ring, cam support plate | \$9.26 | C9179F5 | .34901-07 | 5 | Gasket, primary, .060" AFM, all | \$151.73 |
| C9682 | 12068 | 10 | Seal, engine crankcase | \$61.89 | | | | FL 2007-up | |
| C9215 | 12074 | 1 | Seal, transmission mainshaft | \$10.11 | C9189 | .34917-06 | 10 | Gasket, trans top cover, | \$23.29 |
| C9200 | 12077 | 10 | Seal, main drive gear end | \$67.57 | | | | All Twin Cam, .060" AFM | |
| C9435 | 11105 | 10 | O-ring, engine oil drain, | \$4.54 | C9199F5 | .34934-06 | 5 | Gasket, primary to case, 06-up | |
| | 63783-00 | | oil line retainer FXST only | | | | | FXD and all 2007-up Twin Cam | \$133.44 |
| C9293 | 11145A | 25 | O-ring lower pushrod cover | \$7.95 | C9190F5 | .35607-06 | 5 | Gasket, transmission to engine case | \$81.90 |
| C9667 | 11289A | 25 | O-ring, speed sensor | \$3.92 | | | | All 96 Models Except Softail | |
| C9667 | 11289A | 25 | O-ring, crank sensor, piston cooler jet, | \$3.92 | C9187 | .35654-06 | 10 | Gasket, bearing housing, | \$25.90 |
| | 11140 | | | | | | | All 96 Twin Cam, .060" AFM | |
| C9260 | 12052A | 5 | Seal, clutch | \$11.93 | C9188 | .36805-06 | 10 | Gasket, transmission end cover, | \$24.99 |
| | 17369-06 | | | | | | | All 96 Twin Cam .060" AFM | |
| C9576 | .16719-99A | 10 | Gasket, rocker housing, 020 RC | \$78.99 | C9354F5 | .37101-84B | 5 | Seal, trans shift drum | \$12.33 |
| C9745 | .16775-95B | 2 | Std bore head gasket, .040" thick | \$49.86 | C9004 | .45359-00 | 10 | Seal, interconnect, all B Engines | \$22.67 |
| | | | MLS | | C9145F5 | .60547-06 | 5 | Gasket, primary, All FXD & FXST | \$151.73 |
| C9577 | .17386-99 | 10 | Gasket, rocker cover, 020" RC | \$78.99 | C9679 | .63815-99 | 10 | Breather element | \$15.10 |
| C9579 | .17591-99 | 10 | Gasket, breather assembly, top, | \$10.28 | C9005 | .63869-06 | 10 | Gasket, primary spacer, FXST only | \$10.40 |
| | | | .031" fiber | | C9288 | .65324-83A | 10 | Gasket, exhaust, OE style | \$47.81 |
| C9580 | .17592-99 | 10 | Gasket breather assembly, bottom, | \$10.28 | C9166 | | 10 | Seal, valve stem, with .530" guide O.D. | \$30.38 |
| | | | .031" fiber | | C9440 | | 25 | Derby cover bolt O-rings | \$4.49 |
| C9153 | .18094-02A | 25 | Seal, valve stem, hat style | \$95.73 | | | | | |
| C9578F | .18635-99B | 10 | Gasket, tappet cover, .032" AFM | \$6.81 | | | | | |
| C9575F5 | .25244-99 | 5 | Gasket, cam cover, .060" AFM | \$54.57 | | | | | |



Twin Cam 88

Display Board Complete with Gaskets, Seals & O-Rings

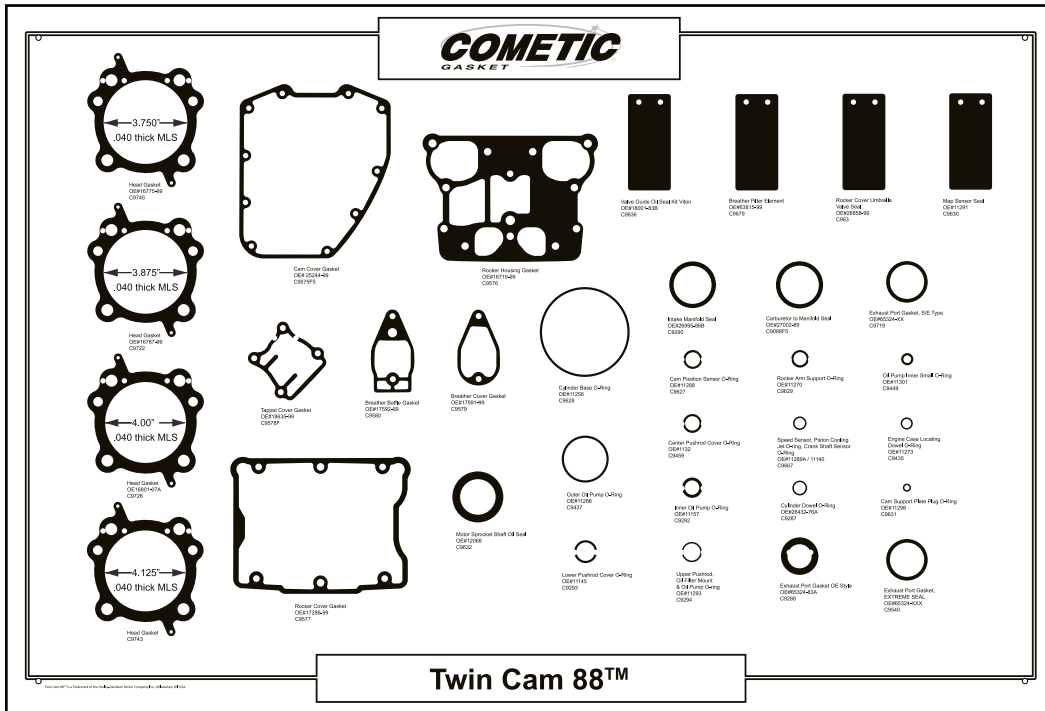

- Sold complete with all Gaskets, Seals & O-Rings and the necessary clamshells, display hooks and xmas treeclips for mounting

- Both Cometic and OE part numbers are printed on boards for easy clarification of parts

- 3 color design, boards measures 48"W x 32"H and are manufactured from 20 mil flexible vinyl and mount easily on 1/8" or 1/4" pegboard

| Part# | Description | List |
|------------|--------------------|----------|
| C9228F-Gas | Gaskets Only | \$887.37 |
| C9228F | Display Board Only | \$94.50 |

| Cometic # | OE# | Qty | Description | List |
|-----------|----------|-----|---|---------|
| C9459 | 11132 | 25 | Center Pushrod Cover O-ring | \$3.92 |
| C9667 | 11140 | 25 | Speed Sensor & Piston Cooling O-Ring | \$3.92 |
| C9293 | 11145 | 25 | Lower Pushrod Cover O-Ring | \$7.95 |
| C9292 | 11157 | 25 | Inner Oil Pump O-Ring | \$20.33 |
| C9628 | 11256 | 10 | Cylinder Base O-Ring | \$16.64 |
| C9629 | 11270 | 10 | Rocker Arm Support O-Ring | \$4.02 |
| C9435 | 11273 | 10 | Engine Case Locating Dowel O-Ring | \$4.54 |
| C9437 | 11286 | 10 | Outer Oil Pump O-Ring | \$2.95 |
| C9627 | 11288 | 10 | Cam Position Sensor O-Ring | \$6.14 |
| C9667 | 11289A | 25 | Crank Shaft Sensor O-Ring | \$3.92 |
| C9630 | 11291 | 10 | Map Sensor Seal | \$15.95 |
| C9294 | 11293 | 10 | Upper Pushrod, Oil Filter Mount & Oil Pump O-Ring | \$10.17 |
| C9631 | 11298 | 10 | Cam Support Plate Plug O-Ring | \$3.92 |
| C9449 | 11301 | 10 | Oil Pump Inner Small O-Ring | \$9.26 |
| C9632 | 12068 | 5 | Motor Sprocket Shaft Oil Seal | \$30.95 |
| C9576 | 16719-99 | 10 | Rocker Housing Gasket | \$78.99 |
| C9745 | 16775-99 | 2 | Twin Cam 3.750" Cylinder Head Gasket (.040") | \$49.86 |
| C9722 | 16787-99 | 2 | Twin Cam 3.875" Cylinder Head Gasket (.040") | \$44.99 |

| Cometic # | OE# | Qty | Description | List |
|-----------|-----------|-----|--|---------|
| C9726 | 16801-07A | 2 | Twin Cam 4" Cylinder Head Gasket (.040") | \$44.99 |
| C9743 | | 2 | Twin Cam 4.125" Cylinder Head Gasket (.040") | \$44.99 |
| C9577 | 17286-99 | 10 | Rocker Cover Gasket | \$78.99 |
| C9579 | 17591-99 | 10 | Breather Cover Gasket | \$10.28 |
| C9580 | 17592-99 | 10 | Breather Baffle Gasket | \$10.28 |
| C9836 | 18001-83B | 25 | Valve Guide Oil Seal Kit 99-04 | \$73.42 |
| C9578F | 18635-99 | 10 | Tappet Cover Gasket | \$6.81 |
| C9575F5 | 25244-99 | 5 | Cam Cover Gasket | \$54.57 |
| C9287 | 26432-76A | 10 | Cylinder Dowel O-Ring | \$11.93 |
| C9633 | 26858-99 | 10 | Rocker Cover Umbrella Valve Seal | \$39.18 |
| C9290 | 26995-86B | 10 | Intake Manifold Seal | \$19.87 |
| C9088F5 | 27002-89 | 5 | Carburetor to Manifold Seal | \$30.99 |
| C9288 | 65324-83A | 10 | Exhaust Port Gasket, OE type | \$47.81 |
| C9719 | 65324-XX | 10 | Exhaust Port Gasket, S/E type | \$40.42 |
| C9540 | 65324-XXX | 10 | Exhaust Port Gasket, Xtreme Seal | \$74.56 |
| C9679 | 63815-99 | 10 | Breather Filter Element | \$15.10 |

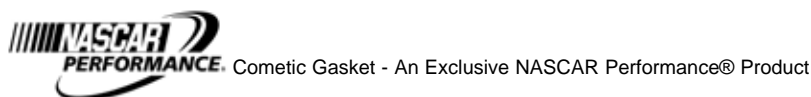



84-99 Big Twin Evolution

Display Board Complete with Gaskets, Seals & O-Rings

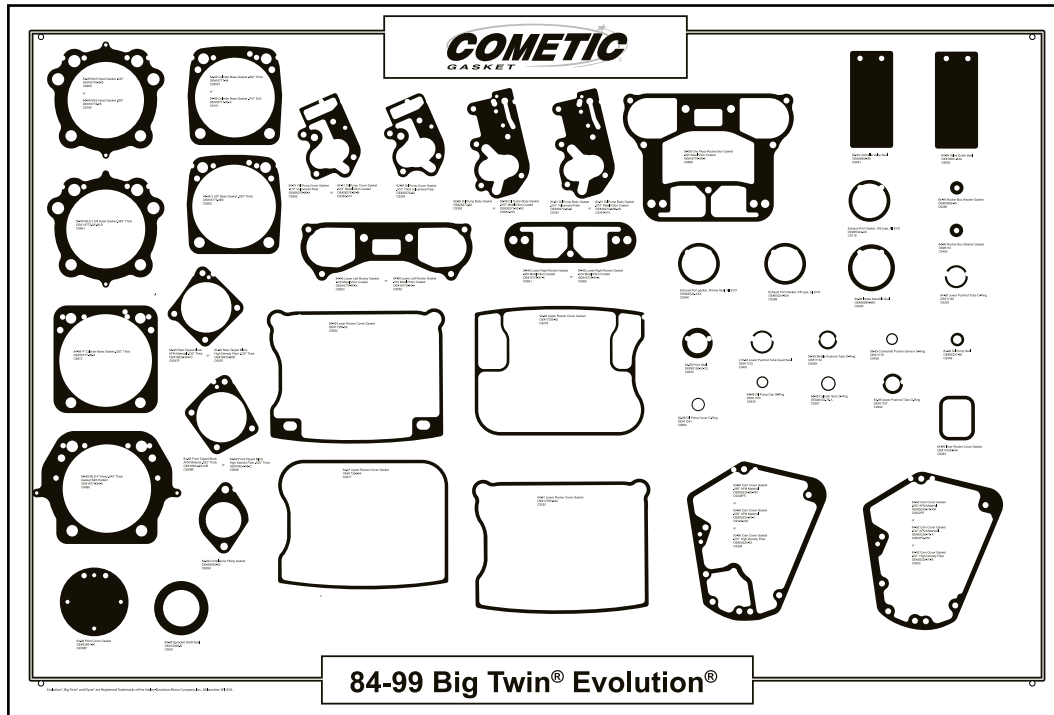

- Sold complete with all Gaskets, Seals & O-Rings and the necessary clamshells, display hooks and xmas treeclips for mounting

- Both Cometic and OE part numbers are printed on boards for easy clarification of parts

- 3 color design, boards measures 48"W x 32"H and are manufactured from 20 mil flexible vinyl and mount easily on 1/8" or 1/4" pegboard

Part#
C9229F-Gas
C9229F

Description
Gaskets Only
Display Board Only

List
\$1,298.52
\$98.28

| Cometic # | OE# | Qty | Description | List |
|-----------|--------------|-----|---|---------|
| C9400 | 6114 | 10 | 84-99 Rocker Box Washer Gasket (Copper) | \$6.58 |
| C9435 | 11105 | 10 | 84-99 Oil Pump Cap O-Ring | \$4.54 |
| C9459 | 11132 | 25 | 84-99 Middle Pushrod Tube O-Ring | \$3.92 |
| C9293 | 11145 | 25 | 84-99 Lower Pushrod Tube O-Ring | \$7.95 |
| C9461 | 11133 | 10 | L79-84 Lower Pushrod Tube Quad Seal | \$9.26 |
| C9292 | 11157 | 25 | 84-99 Upper Pushrod Tube O-Ring | \$20.33 |
| C9438 | 11170 | 10 | 95-99 Crankshaft Position Sensor O-Ring | \$6.58 |
| C9684 | 11241 | 10 | 92-98 Oil Pump Cover O-Ring | \$2.56 |
| C9351 | 12026-B | 5 | 84-99 Sprocket Shaft Seal | \$14.59 |
| C9180 | 16773-85 | 2 | 84-99 MLS Head Gasket (.060") | \$66.83 |
| C9689 | 16770-84B | 2 | 84-99 MLS Head Gasket (.040") | \$44.90 |
| C9691 | 16773-85-MLS | 2 | 84-99 MLS 3 5/8" Head Gasket (.040") | \$44.90 |
| C9880 | 16773-96-X | 2 | 84-99 MLS 4" Head Gasket S&S Pattern (.040") | \$44.90 |
| C9551 | 16777-94 | 2 | 84-99 Cylinder Base Gasket SLS (Metal/Viton .020") | \$23.85 |
| C9101 | 16777-83-A | 2 | 84-99 Cylinder Base Gasket SLS (Metal/Viton .010") | \$23.85 |
| C9552 | 16777-86S | 2 | 84-99 3 5/8" Base Gasket (Paper) | \$23.85 |
| C9872 | 16777-96-X | 2 | 84-99 4" Cylinder Base Gasket (.020") | \$23.85 |
| C9866 | 16779-99-X | 10 | 84-99 Lower Left & Right Rocker Box Gasket (One Piece Metal/Viton coated .020") | \$77.23 |
| C9561 | 16778-97-X | 5 | 84-99 Lower Right Rocker Gasket (Metal/Viton coated .020") | \$21.18 |
| C9560 | 16778-84-A | 5 | 84-99 Lower Right Rocker Gasket (Metal/Viton coated .010") | \$21.18 |
| C9563 | 16779-97-X | 5 | 84-99 Lower Left Rocker Gasket (Metal/Viton coated .020") | \$25.21 |
| C9562 | 16779-84-A | 5 | 84-99 Lower Left Rocker Gasket (Metal/Viton coated .010") | \$25.21 |
| C9281 | 17355-84A | 5 | 84-91 Lower Rocker Cover Gasket (Rubber) | \$29.19 |
| C9282 | 17355-92 | 5 | 92-99 Lower Rocker Cover Gasket (Rubber) | \$29.19 |
| C9277 | 17356-84 | 5 | 84-91 Upper Rocker Cover Gasket (Rubber) | \$29.19 |
| C9278 | 17356-92 | 5 | 92-99 Upper Rocker Cover Gasket (Rubber) | \$29.19 |
| C9283 | 17358-84A | 10 | 84-99 Inner Rocker Cover Gasket (Rubber) | \$18.56 |
| C9836 | 18001-83A | 25 | 84-99 Valve Guide Seal (Viton) | \$73.42 |

| Cometic # | OE# | Qty | Description | List |
|-------------|--------------|-----|--|---------|
| C9297 | 18633-48D | 10 | 84-99 Rear Tappet Block Gasket (High Density Fiber) | \$6.58 |
| C9297F | 18633-48A/C | 10 | 84-99 Rear Tappet Block Gasket (AFM) | \$6.58 |
| C9298 | 18634-48-C | 10 | 84-99 Front Tappet Block Gasket (High Density Fiber) | \$7.95 |
| C9298F | 18634-48-A/B | 10 | 84-99 Front Tappet Block Gasket (AFM) | \$7.95 |
| C9328F5 | 25225-93-XM | 5 | 93-99 Cam Cover Gasket (AFM .060") | \$33.50 |
| C9328F5-032 | 25225-93-X | 5 | 93-99 Cam Cover Gasket (AFM .032") | \$33.50 |
| C9328 | 25225-93 | 10 | 93-99 Cam Cover Gasket (High Density Fiber .031") | \$22.71 |
| C9302F5 | 25225-70-XM | 5 | 84-92 Cam Cover Gasket (AFM Material .060") | \$29.58 |
| C9302F5-032 | 25225-70-X | 5 | 84-92 Cam Cover Gasket (AFM Material .032") | \$29.58 |
| C9302 | 25225-70-B | 5 | 84-92 Cam Cover Gasket (High Density Fiber .031") | \$18.73 |
| C9349 | 26227-58 | 5 | 84-99 Oil Pump Seal | \$11.93 |
| C9381 | 26273-80-B | 10 | 84-91 Oil Pump Body Gasket (Vulcanized Fiber) | \$9.26 |
| C9381-010 | 26273-80B-XS | 10 | 84-91 Oil Pump Body Gasket (Metal/Viton coated .010") | \$15.94 |
| C9383 | 26273-92 | 10 | 92-99 Oil Pump Body Gasket (Vulcanized Fiber .010") | \$9.26 |
| C9383-010 | 26273-92-XS | 10 | 92-99 Oil Pump Body Gasket (Metal/Viton coated .010") | \$15.94 |
| C9382 | 26276-80-A | 10 | 84-91 Oil Pump Cover Gasket (Vulcanized Fiber) | \$7.95 |
| C9382-010 | 26276-80-M | 10 | 84-91 Oil Pump Cover Gasket (Metal/Viton coated .010") | \$15.94 |
| C9384 | 26276-92 | 10 | 92-99 Oil Pump Cover Gasket (Vulcanized Fiber .010") | \$9.26 |
| C9287 | 26432-76-A | 10 | 84-99 Cylinder Stud O-Ring | \$11.93 |
| C9481 | 26856-89 | 10 | 93-99 Umbrella Valve Seal | \$10.56 |
| C9290 | 26995-86A | 10 | 90-99 Intake Manifold Seal | \$19.87 |
| C9299 | 29242-83 | 10 | 84-89 Compliance Fitting Gasket | \$13.24 |
| C9306F | 32591-80 | 10 | 84-99 Point Cover Gasket | \$11.23 |
| C9286 | 63858-49 | 10 | 84-99 Rocker Box Washer Gasket (Vulcanized Fiber) | \$5.86 |
| C9288 | 65324-83A | 10 | Exhaust Port Gasket, OE type | \$47.81 |
| C9719 | 65324-XX | 10 | Exhaust Port Gasket, S/E type | \$40.42 |
| C9540 | 65324-XXX | 10 | Exhaust Port Gasket, XTREME SEAL | \$74.56 |
| C9350 | 83162-51-DL | 5 | 84-99 Point Seal (Double Lip) | \$18.56 |



36-84 Big Twin

Display Board Complete with Gaskets, Seals & O-Rings

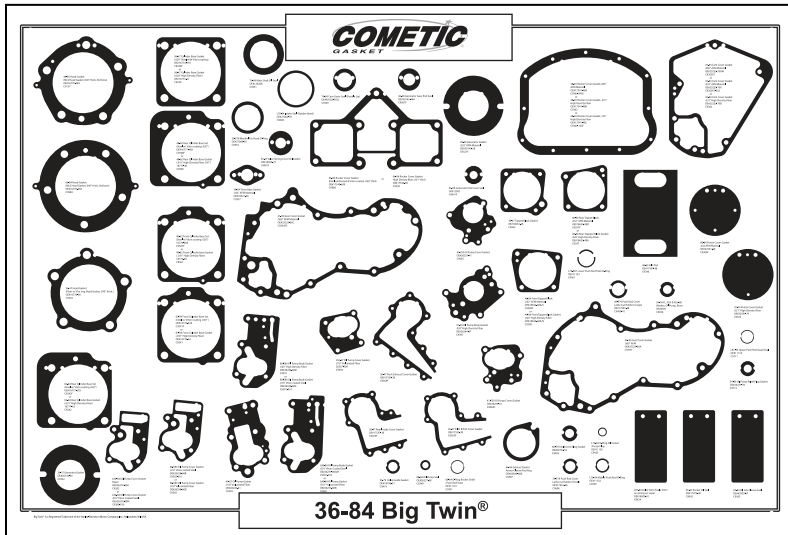

- Sold complete with all Gaskets, Seals & O-Rings and the necessary clamshells, display hooks and xmas treeclips for mounting
- Both Cometic and OE part numbers are printed on boards for easy clarification of parts
- 3 color design, boards measures 48"W x 32"H and are manufactured from 20 mil flexible vinyl and mount easily on 1/8" or 1/4" pegboard

| Part# | Description | List |
|------------|--------------------|------------|
| C9230F-Gas | Gaskets Only | \$1,437.48 |
| C9230F | Display Board Only | \$98.28 |

| Cometic # | OE# | Qty | Description | List |
|------------|-----------|-----|---|---------|
| C9034 | 6581 | 5 | 54-78 Oil Pump Relief Valve Plug Gasket | \$10.40 |
| C9451 | 11101 | 10 | 66-84 O-Ring Rocker Shaft/Pushrod Tube | \$4.49 |
| C9435 | 11105 | 10 | L70-84 O-Ring Oil Screen/Pump Plug | \$4.54 |
| C9711 | 11118 | 25 | L81-84 Upper Pushrod Quad Seal | \$19.93 |
| C9459 | 11132 | 25 | L79-84 Middle Pushrod O-Ring | \$3.92 |
| C9461 | 11133 | 10 | L79-E81 Lower Pushrod Tube O-Ring | \$9.26 |
| C9041F | 12002 | 5 | 61-69 Generator End Cover Seal | \$23.92 |
| C9351 | 12026B | 5 | 70-84 Main Shaft Oil Seal | \$14.59 |
| C9239 | 16770-36 | 2 | 36-47 Head Gasket (Fiber w/ Fire ring Head Gasket .043") | \$42.59 |
| C9137 | 16770-48X | 2 | 48-65 Head Gasket (MLS Head Gasket .040" Std bore) | \$44.99 |
| C9984 | 16770-66X | 2 | 66-84 Head Gasket (MLS Head Gasket .040" Std bore) | \$44.99 |
| C9240F | 16774-21X | 2 | 36-47 Cylinder Base Gasket (.020" Steel with Viton coating) | \$23.85 |
| C9240 | 16774-21 | 2 | 36-47 Cylinder Base Gasket (.020" High Density Fiber) | \$11.36 |
| C9567F | 16776-48X | 2 | 48-62 Front Cylinder Base Set (Steel w/ Viton coating .020") | \$23.85 |
| C9567 | 16776-48 | 10 | 48-62 Front Cylinder Base Gasket (.031" High Density Fiber) | \$20.90 |
| C9241F | 16776-63X | 2 | 63-84 Front Cylinder Base Set (Steel w/ Viton Coating .020") | \$23.85 |
| C9241 | 16776-63 | 2 | 63-84 Front Cylinder Base Gasket (.031" High Density Fiber) | \$20.90 |
| C9568F | 16777-48X | 2 | 48-62 Rear Cylinder Base Set (Steel w/ Viton coating .020") | \$23.85 |
| C9568 | 16777-48 | 10 | 48-62 Rear Cylinder Base Gasket (.031" High Density Fiber) | \$20.90 |
| C9242F | 16777-63X | 2 | 63-84 Rear Cylinder Base Set (Steel w/ Viton coating .020") | \$23.85 |
| C9242 | 16777-63 | 10 | 63-84 Rear Cylinder Base Gasket (.031" High Density Fiber) | \$20.90 |
| C9042 | 17475-38 | 5 | 36-47 Rocker Oil Seal | \$11.70 |
| C9346 | 17507-48 | 10 | 48-65 Felt Pad | \$22.54 |
| C9053F | 17535-38 | 5 | 36-47 F/Int R/Exh Cover Gasket | \$21.84 |
| C9055F | 17537-38 | 5 | 36-47 Rear Intake Cover Gasket | \$21.84 |
| C9059F | 17539-38 | 5 | 36-47 Front Exhaust Cover Gasket | \$21.84 |
| C9986 | 17540-69X | 2 | 66-84 Rocker Cover Gasket (Steel, embossed & Viton coated, .020") | \$21.18 |
| C9336 | 17540-69 | 10 | 66-84 Rocker Cover Gasket (High Density Fiber) | \$18.79 |
| C9342-AFM | 17541-48A | 2 | 48-65 Rocker Cover Gasket, .060" | \$4.49 |
| C9342 | 17541-48B | 10 | 48-65 Rocker Cover Gasket (High Density Fiber, .031") | \$44.52 |
| C9342-125F | 17541-48C | 2 | 48-65 Rocker Cover Gasket, .125" (High Density Fiber) | \$59.96 |
| C9696 | 17955-36 | 10 | 36-E79 Pushrod Cover Lathe Cut Rubber (Small) | \$6.14 |
| C9409-10 | 17955-48 | 10 | 48-E79 Pushrod Cover Lathe Cut Rubber (Large) | \$3.92 |
| C9424 | 18000-81 | 25 | L81-84 Valve Stem Seals, Viton w/ spring on wiper | \$45.25 |
| C9419 | 18196-51 | 20 | 51-79 Valve Guide Gasket | \$11.13 |

| Cometic # | OE# | Qty | Description | List |
|-------------|-------------|-----|--|---------|
| C9061F | 18265-37 | 10 | 36-47 Valve Spring Cover Oil Gasket | \$21.43 |
| C9062 | 18632-36 | 5 | 36-47 Tappet Block Gasket | \$8.01 |
| C9297F | 18633-48D | 10 | 48-84 Rear Tappet Block (.032" AFM) | \$6.58 |
| C9297 | 18633-48A | 10 | 48-84 Rear Tappet Block Gasket (.020" High Density Fiber) | \$6.58 |
| C9298F | 18634-48A/C | 10 | 48-84 Front Tappet Block (.032" AFM Material) | \$7.95 |
| C9298 | 18634-48A/B | 10 | 48-84 Front Tappet Block Gasket (.020" High Density Fiber) | \$7.95 |
| C9709 | 25225-36A | 5 | 36-40 Gear Cover Gasket, .060" AFM | \$55.42 |
| C9334F5 | 25225-36C | 5 | 41-69 Gear Cover Gasket, .060" AFM | \$55.42 |
| C9302F5 | 25225-70XM | 5 | 70-84 Cam Cover Gasket, .060" AFM | \$29.58 |
| C9302F5-032 | 25225-70X | 5 | 70-84 Cam Cover Gasket, .032" AFM | \$29.58 |
| C9302 | 25225-70B | 5 | 70-84 Cam Cover Gasket (.031" High Density Fiber) | \$18.73 |
| C9349 | 26227-58 | 5 | 68-84 Oil Pump Seal | \$11.93 |
| C9715 | 26231-78 | 10 | 54-80 Oil Pump Relief Plug Gasket | \$13.24 |
| C9397 | 26244-37 | 10 | 37-59 Oil Pump Body Gasket (.020" High Density Fiber) | \$8.98 |
| C9393 | 26245-41 | 10 | 41-67 Oil Pump Gasket (.010" Vulcanized Fiber) | \$8.34 |
| C9391 | 26246-68D | 10 | 68-E80 Oil Pump Body Gasket (.020" High Density Fiber) | \$7.95 |
| C9391-010 | 26246-68X | 10 | 68-E80 Oil Pump Body Gasket (.010" Viton Coated Sreel) | \$15.94 |
| C9064F | 26255-41 | 5 | 41-E50 Oi Pump Cover Gasket | \$9.05 |
| C9065 | 26257-41 | 5 | 41-E50 Oi Pump Cover Gasket | \$9.05 |
| C9394 | 26257-50A | 10 | L50-67 Oil Pump Cover Gasket (.010" Vulcanized Fiber) | \$7.95 |
| C9392 | 26258-68D | 10 | 68-E80 Oil Pump Cover Gasket (.010" Vulcanized Fiber) | \$13.24 |
| C9392-010 | 26258-68B | 10 | 68-E80 Oil Pump Cover Gasket (.010" Viton Coated Steel) | \$15.94 |
| C9381 | 26273-80B | 10 | L80-84 Oil Pump Body Gasket (.010" Vulcanized Fiber) | \$9.26 |
| C9381-010 | 26273-80AM | 10 | L80-84 Oil Pump Body Gasket (.010" Viton Coated Steel) | \$15.94 |
| C9382 | 26276-80A | 10 | L80-84 Oil Pump Cover Gasket (Paper) | \$7.95 |
| C9382-010 | 26276-80M | 10 | L80-84 Oil Pump Cover Gasket (.010" Viton coated steel) | \$15.94 |
| C9453 | 27060-55 | 10 | 55-E78 Manifold to Head O-Ring | \$6.58 |
| C9608 | 27062-78 | 10 | L78-84 Intake Seal (Rubber Band) | \$19.77 |
| C9322 | 30143-30 | 10 | 36-57 Generator Gasket | \$10.56 |
| C9321F | 30143-58 | 5 | 58-69 Generator Gasket (.032" AFM) | \$5.28 |
| C9067F | 30145-46A | 5 | 46-69 Generator Gear End Seal | \$23.92 |
| C9337 | 32521-36 | 10 | 36-64 Timer Base Gasket (.032" AFM) | \$5.28 |
| C9323 | 32591-70 | 10 | 70-79 Points Cover Gasket (.031" High Density Fiber) | \$11.18 |
| C9306F | 32591-80 | 10 | 80-84 Points Cover Gasket (.032" AFM) | \$11.13 |
| C9403 | 62702-52 | 10 | 66-E70 Oil Screen Plug Gasket | \$11.93 |
| C9365 | 63529-57 | 10 | 63-84 Oil Line Sleeve Seal | \$8.98 |
| C9587 | 65834-68X | 10 | 66-84 Exhaust Gasket (Armor Clad w/Fire Ring) | \$32.66 |
| C9350 | 83162-51DL | 5 | 70-84 Cam Cover Seal (Double Lip) | \$18.56 |



Big Twin Primary

Display Board Complete with Gaskets, Seals & O-Rings

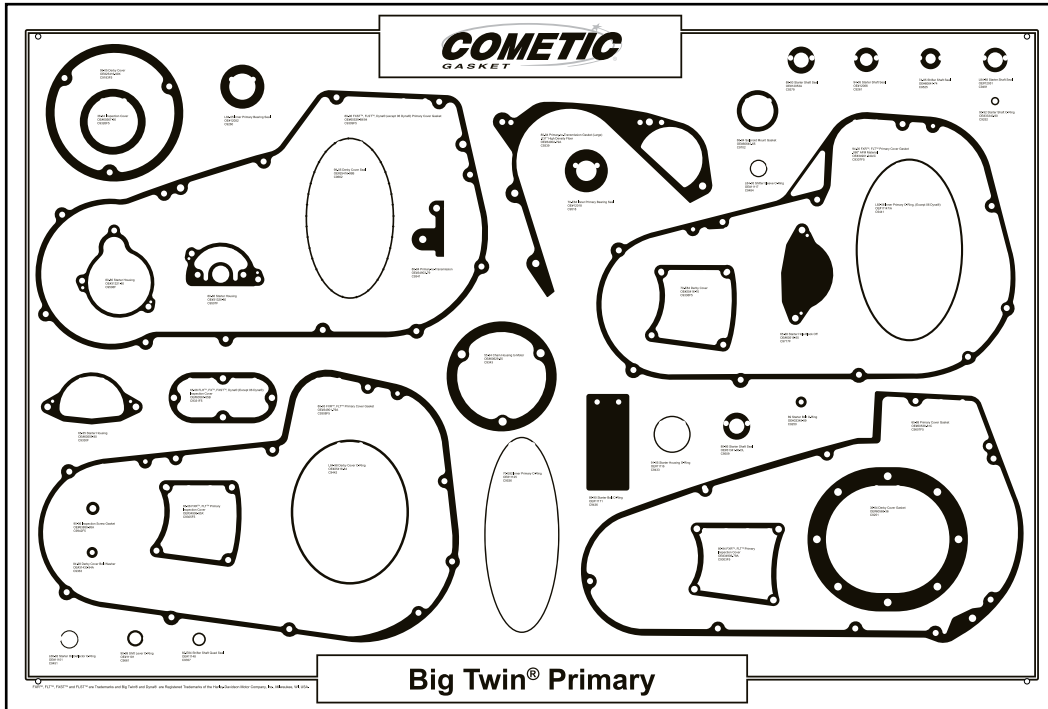

- Sold complete with all Gaskets, Seals & O-Rings and the necessary clamshells, display hooks and xmas treeclips for mounting
- Both Cometic and OE part numbers are printed on boards for easy clarification of parts
- 3 color design, boards measures 48"W x 32"H and are manufactured from 20 mil flexible vinyl and mount easily on 1/8" or 1/4" pegboard

| Part# | Description | List |
|------------|--------------------|------------|
| C9231F-Gas | Gaskets Only | \$1,257.20 |
| C9231F | Display Board Only | \$94.50 |

| Cometic # | OE# | Qty | Description | List |
|--------------|-------------|-------|---|----------|
| C9400..... | 6114 | 10... | 84-99 Rocker Box Washer Gasket (Copper) | \$6.58 |
| C9451..... | 11101 | 10... | L66-82 Starter Oil Deflector O-Ring | \$4.32 |
| C9433..... | 11116 | 25... | 91-05 Starter Housing O-Ring | \$6.58 |
| C9484..... | 11117 | 25... | L84-05 FXR, Dyna Shifter Sleeve O-Ring | \$11.93 |
| C9536..... | 11125 | 10... | 70-E82 Inner Primary O-Ring | \$65.87 |
| C9441..... | 11147/A | 10... | L82-06 Inner Primary O-Ring, Except 06 DYNA | \$22.54 |
| C9357..... | 11148 | 10... | 82-E84 Shifter Shaft Quad Seal | \$11.93 |
| C9436..... | 11171 | 10... | L84-88 Starter Bolt O-Ring | \$6.58 |
| C9661..... | 11191 | 25... | 90-99 FXST, FLST Shift Lever O-Ring | \$4.32 |
| C9518..... | 12018 | 5.... | 70-E84 Inner primary Bearing Seal | \$14.59 |
| C9491..... | 12051 | 5.... | L84-88 Starter Shaft Seal | \$11.93 |
| C9260..... | 12052 | 5.... | L84-05 Inner Primary Bearing Seal (Double Lip) | \$11.93 |
| C9379..... | 12053A | 5.... | 89-93 Starter Shaft Seal | \$18.56 |
| C9261..... | 12066 | 5.... | 94-05 Starter Shaft Seal | \$18.56 |
| C9338F5..... | 25416-70 | 5.... | 70-E84 Derby Cover Gasket (.060" AFM Material) | \$37.94 |
| C9442..... | 25416-84 | 10... | L84-98 Derby Cover O-Ring | \$17.21 |
| C9662..... | 25416-99B | 5.... | 99-05 Derby Cover Seal | \$19.30 |
| C9183F5..... | 25416-99X | 5.... | 99-05 Derby Cover Gasket (.060" AFM Material) | \$26.80 |
| C9507F..... | 31320-80 | 10... | 80-86 Starter Housing Gasket (.032" AFM Material) | \$6.58 |
| C9508F..... | 31321-80 | 10... | 80-86 Starter Housing Gasket (.032" AFM Material) | \$13.92 |
| C9509..... | 31341-80-DL | 5.... | 80-86 Starter Shaft Seal (Double Lip) | \$21.18 |
| C9363..... | 31433-84A | 5.... | 84-98 Derby Cover Bolt Washer (Metal) | \$6.58 |
| C9252..... | 33340-90 | 10... | 90-92 Starter Shaft O-Ring | \$11.65 |
| C9250..... | 33345-89 | 10... | 89 Starter Bolt O-Ring | \$19.76 |
| C9308F5..... | 34901-79A | 5.... | 80-93 FXR,FLT Primary Cover Gasket (.060" AFM Material) | \$151.73 |

| Cometic # | OE# | Qty | Description | List |
|--------------|-------------|-------|---|----------|
| C9307F5..... | 34901-94A/C | 5.... | 94-06 FXR, FLT Primary Cover Gasket (.060" AFM Material) | \$151.73 |
| C9339..... | 34902-79A | 10... | 80-84 Primary-to-Transmission Gasket (Large), .031" High Density Fiber | \$69.62 |
| C9341..... | 34903-79 | 10... | 80-84 Primary-to-Transmission Gasket (Small), .039" High Density Fiber | \$6.58 |
| C9303F5..... | 34906-79A | 5.... | 80-84 FXR,FLT Primary Inspection Cover Gasket (.060" AFM Material) | \$32.19 |
| C9305F5..... | 34906-85X | 5.... | 85-06 FXR,FLT Primary Inspection Rigid Mount (.060" AFM Material) | \$32.19 |
| C9717F..... | 60518-65 | 10... | 65-88 Starter Hole Block Off Gasket (.032" AFM Material) | \$26.69 |
| C9607F5..... | 60538-81C | 5.... | 65-88 Primary Cover Gasket, Rigid Mount (.060" AFM Material) | \$151.73 |
| C9309F5..... | 60539-89/94 | 5.... | 89-06 FXST,FLST, Dyna, Expect 06 DYNA Primary Cover Gasket (.060" AFM Material) | \$151.73 |
| C9330F..... | 60559-80 | 10... | 65-85 Starter Housing Gasket (.032" AFM Material) | \$7.95 |
| C9251..... | 60565-36 | 5.... | 36-64 Derby Cover Gasket | \$37.94 |
| C9326F5..... | 60567-36 | 10... | 36-64 Inspection Cover Gasket (.125" Cork) | \$20.55 |
| C9331F5..... | 60567-65B | 5.... | 65-06 FLH, FX, FXST Dyna Inspection Cover Gasket, Except 06 Dyna (.060" AFM Material) | \$23.17 |
| C9343..... | 60629-55 | 10... | 55-64 Chain Housing to Motor Gasket (.031" High Density Fiber) | \$222.32 |
| C9525..... | 60641-74 | 5.... | 74-85 Shifter Shaft Seal | \$13.24 |
| C9702..... | 60645-65 | 10... | 65-84 Solenoid Mount Gasket (.190" Closed cell foam) | \$7.84 |
| C9942F5..... | 63859-95A | 5.... | 95-06 Inspection Screw Gasket Pair | \$9.77 |



Big Twin Transmission

Display Board Complete with Gaskets, Seals & O-Rings

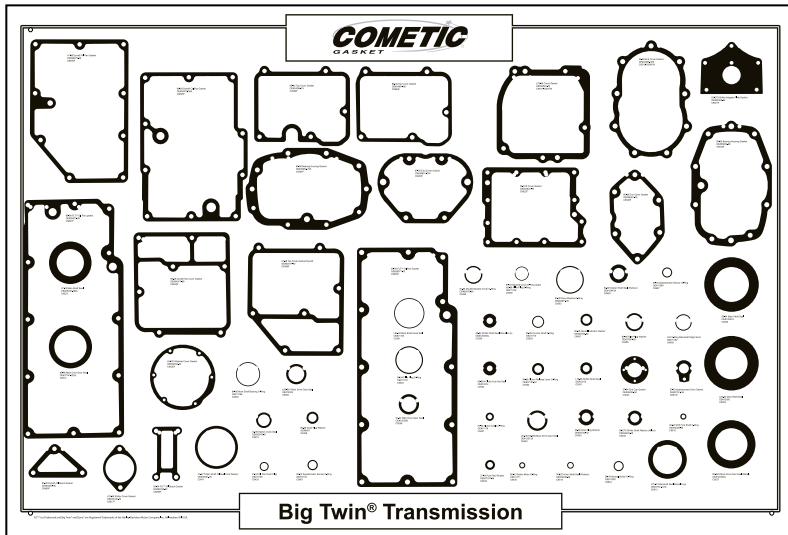

- Sold complete with all Gaskets, Seals & O-Rings and the necessary clamshells, display hooks and xmas treeclips for mounting
- Both Cometic and OE part numbers are printed on boards for easy clarification of parts
- 3 color design, boards measures 48"W x 32"H and are manufactured from 20 mil flexible vinyl and mount easily on 1/8" or 1/4" pegboard

| Part# | Description | List |
|-----------|--------------------|------------|
| C9232-Gas | Gaskets Only | \$1,056.42 |
| C9232F | Display Board Only | \$98.28 |

| Cometic # | OE# | Qty | Description | List | Cometic # | OE# | Qty | Description | List |
|--------------|-----------|-----|--|---------|--------------|------------|-----|--|---------|
| C9498 | 6007 | 10 | 80-98 Drain Plug Washer | \$8.41 | C9520F | 34552-52 | 10 | 52-E79 Ratchet Cover Gasket (.032" AFM Material) | \$14.59 |
| C9435 | 11105 | 10 | 91-04 Oil Pan Drian Plug O-Ring | \$4.54 | C9521F | 34565-52 | 10 | 52-E79 Shifter Adapter Plate Gasket (.032" AFM Material) | \$6.58 |
| C9529 | 11115 | 10 | 65-86 Counter Shaft O-Ring | \$7.95 | C9522F | 34824-36 | 10 | 36-E79 Cover Gasket (.060" AFM Material) | \$9.26 |
| C9459 | 11132 | 25 | 91-04 Dipstick Cover O-Ring | \$3.92 | C9516-032AFM | 34824-79 | 10 | L79-86 Cover Gasket (.032" AFM Material) | \$6.58 |
| C9667 | 11140 | 25 | 95-04 Speedometer Sensor O-Ring | \$3.92 | C9499F | 34904-79 | 10 | 80-85 Top Cover Gasket (.032" AFM Material) | \$29.24 |
| C9495 | 11162 | 25 | L84 O-Ring Mainshaft (right end) | \$6.58 | C9983F | 34904-86 | 10 | 86-04 Top Cover Gasket (.032" AFM Material) | \$23.74 |
| C9361 | 11165 | 10 | L84-04 Main Shaft Quad Seal | \$13.24 | C9488F | 34917-90 | 10 | 91-98 Top Cover Gasket Dyna (.032" AFM Material) | \$33.99 |
| C9530 | 11166 | 25 | 84-86 Main Shaft Bearing O-Ring | \$7.95 | C9645F | 34917-99 | 10 | 99-04 Dyna Top Cover Gasket (.060" AFM Material) | \$23.34 |
| C9436 | 11171 | 10 | 86-91 Starter Motor O-ring | \$6.58 | C9523 | 35230-39DL | 5 | 37-79 Main Shaft Seal | \$21.18 |
| C9263 | 11178 | 10 | 87-04 Filler Plug O-Ring | \$5.28 | C9411 | 35231-36 | 10 | 37-E77 Main Shaft Oil Seal Cork Washer | \$7.95 |
| C9447 | 11179 | 25 | 87-04 Clutch Cable O-Ring | \$3.92 | C9264F | 35652-79X | 10 | 80-98 Bearing Housing Gasket (.032" AFM Material) | \$31.28 |
| C9667 | 11289 | 25 | 99-04 Speedometer Sensor O-Ring | \$3.92 | C9644F | 35653-98 | 10 | 99-05 Bearing Housing Gasket (.032" AFM Material) | \$25.90 |
| C9642 | 11290 | 10 | 99-04 Neutral Switch O-Ring | \$11.93 | C9243 | 36025-36 | 10 | 37-64 End Cap Gasket (.020" High Density Fiber) | \$10.92 |
| C9531 | 12010 | 5 | L79-86 Shifter Shaft Seal | \$11.47 | C9526F | 36801-79 | 10 | 80-86 End Cover Gasket (.032" AFM Material) | \$17.43 |
| C9493 | 12013A | 5 | 65-E66/L81-90 Main Drive Gear Seal | \$11.18 | C9483F | 36801-87A | 10 | 87-05 End Cover Gasket (.032" AFM Material) | \$24.99 |
| C9494 | 12014 | 5 | 65-E84 Clutch Hub Nut Seal | \$7.95 | C9496 | 37091-80 | 10 | 80-86 Filler Plug Washer (.094" Nylon) | \$17.54 |
| C9506 | 12022 | 5 | L66-E81 Main Drive gear Seal | \$11.18 | C9354 | 37101-84 | 1 | 84-86 Clutch Release Lever O-Ring | \$2.61 |
| C9258 | 12035B | 5 | 91-04 Main Drive gear Seal | \$9.26 | C9249 | 37337-36 | 10 | 37-64 Pushrod Rubber | \$59.80 |
| C9528 | 12043A | 5 | 80-86 Starter Shaft Seal (Rubber) | \$10.56 | C9513 | 37741-67A | 5 | L79-81 Mainshaft Seal (Double Lip) | \$26.51 |
| C9527 | 12044DL | 1 | 80-E84 Main Drive Gear Seal (Metal) | \$7.95 | C9514 | 37741-82DL | 5 | 82-86 Main Drive Gear Seal (Double Lip) | \$30.49 |
| C9259 | 12045DL | 5 | 80-04 Shifter Shaft Seal (Double lip) | \$11.93 | C9489F | 62423-90 | 10 | 91-98 Dyna Oil Spout Gasket (.032" AFM Material) | \$11.93 |
| C9359 | 12050 | 1 | L84-94 Main Shaft Seal | \$5.28 | C9266F | 62432-93 | 10 | 93-04 FLT Oil Spout Gasket (.032" AFM Material) | \$46.17 |
| C9262 | 12067A | 1 | 95-04 Main Shaft Seal | \$6.58 | C9485 | 62672-90 | 10 | 91-98 Dyna Dipstick Cover O-Ring | \$6.58 |
| C9490F | 26072-90 | 10 | 91-98 Dyna Oil Pan Gasket (.032" AFM Material) | \$42.41 | C9263 | 62673-90 | 10 | 91-98 Dyna Dipstick O-Ring | \$5.28 |
| C9646F | 26072-99A | 10 | 99-09 Dyna Oil Pan Gasket (.060" AFM Material) | \$92.33 | C9403 | 62702-52 | 10 | 36-86 Drain Plug Washer | \$11.93 |
| C9265F | 26077-93 | 5 | 93-98 FLT Oil Pain Gasket (.060" AFM Material) | \$46.17 | C9512F | 67141-36 | 10 | 37-83 Speedometer Drive Gasket (.032" AFM Material) | \$6.58 |
| C9647F | 26077-99 | 10 | 99-09 FLT Oil Pan Gasket (.060" AFM Material) | \$92.33 | | | | | |
| C9497 | 33043-80 | 10 | 80-92 Neutral Indicator Washer (.063" Nylon) | \$8.41 | | | | | |
| C9374 | 33076-37 | 10 | 37-86 Starter Crank Seal | \$11.93 | | | | | |
| C9517F | 33196-79 | 10 | L79-86 Shifter Cover Gasket (.032" AFM Material) | \$7.95 | | | | | |
| C9515-032AFM | 33295-36X | 10 | 36-86 End Cover Gasket (.032" AFM Mataterial) | \$37.30 | | | | | |
| C9519 | 34036-36 | 10 | 36-E79 Cam Shaft Seal (Rubber) | \$6.58 | | | | | |
| C9510 | 34026-80 | 10 | 36-84 Shift Fork Shaft O-Ring | \$6.58 | | | | | |
| C9248 | 34459-26 | 10 | 36-E79 Shifter Shaft Washer (Nylon) | \$9.88 | | | | | |



86-00 XL Evolution

Display Board Complete with Gaskets, Seals & O-Rings

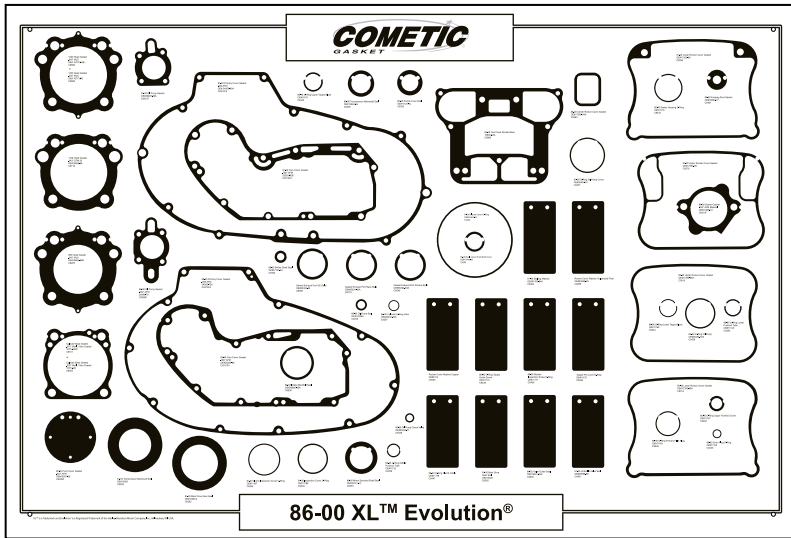

- Sold complete with all Gaskets, Seals & O-Rings and the necessary clamshells, display hooks and xmas treeclips for mounting
- Both Cometic and OE part numbers are printed on boards for easy clarification of parts
- 3 color design, boards measures 48"W x 32"H and are manufactured from 20 mil flexible vinyl and mount easily on 1/8" or 1/4" pegboard

| Part# | Description | List |
|------------|--------------------|------------|
| C9233F-Gas | Gaskets Only | \$1,332.58 |
| C9233F | Display Board Only | \$98.28 |

| Cometic # | OE# | Qty | Description | List |
|-----------|-----------|-----|--|---------|
| C9400 | 6114 | 10 | 86 Rocker Cover Washer (Copper) | \$6.58 |
| C9435 | 11105 | 10 | 86-00 Drain Plug O-Ring | \$4.54 |
| C9448 | 11110 | 10 | 86-90 O-Ring Tappet Guide Screw | \$5.28 |
| C9433 | 11116 | 25 | 86-00 Starter Housing O-Ring | \$6.58 |
| C9355 | 11124-DL | 5 | 86-00 Points Cover Seal (Double Lip) | \$10.28 |
| C9459 | 11132 | 25 | 86-90 O-Ring Middle Pushrod Tube | \$3.92 |
| C9446 | 11139 | 10 | 86-90 O-Ring Primary Filler Plug | \$6.58 |
| C9293 | 11145 | 25 | 86-90 O-Ring Lower Pushrod Tube | \$7.95 |
| C9292 | 11157 | 25 | 86-90 O-Ring Upper Push Rod Cover | \$20.33 |
| C9443 | 11167 | 10 | 86-90 O-Ring Upper Tappet Block | \$10.56 |
| C9444 | 11168 | 10 | 86-90 O-Ring Lower Tappet Block | \$10.56 |
| C9436 | 11171 | 10 | 86-00 Starter/Inspection Screw O-Ring | \$6.58 |
| C9296 | 11176 | 10 | Tappet Pin Cover O-Ring | \$1.03 |
| C9447 | 11179 | 25 | 88-00 O-Ring Clutch Cable | \$3.92 |
| C9434 | 11187 | 10 | 91-93 Clutch Inspection Cover O-Ring | \$7.95 |
| C9439 | 11188 | 10 | 91-00 Inspection Cover O-Ring | \$7.95 |
| C9294 | 11190 | 10 | 91-00 O-Ring Upper Pushrod Cover | \$10.17 |
| C9362 | 12030 | 5 | 91-00 Main Drive Gear Seal | \$10.56 |
| C9376 | 12036A | 5 | 86-90 Oil Pump Seal (Metal) | \$7.66 |
| C9356 | 12049-DL | 5 | 86-90 Transmission Mainshaft Seal | \$10.28 |
| C9359 | 12050 | 1 | 91-94 Transmission Mainshaft Seal | \$5.28 |
| C9262 | 12067A | 1 | 91-00 Main Drive Gear Seal | \$6.58 |
| C9205 | 16664-86B | 2 | 86-00 883 Head Gasket | \$44.99 |
| C9718 | 16665-86 | 2 | 86-87 1100 Head Gasket (.043" CFM20 W/ Fire Ring) | \$42.54 |
| C9689 | 16770-84B | 2 | 88-08 1200 Head Gasket (.040 MLS) | \$44.99 |
| C9688 | 16773-85 | 2 | 88-08 1200 Head Gasket (.030" MLS) | \$44.99 |
| C9553 | 16774-96 | 2 | 86-00 Cylinder Base Gasket (.020" Steel Viton coated) | \$23.85 |
| C9101 | 16774-86D | 2 | 86-00 Cylinder Base Gasket (.010" Steel Viton coated) | \$23.85 |
| C9866 | 16800-84A | 10 | 86-up One piece rocker base (.020" Steel Viton coated) | \$77.23 |
| C9014 | 17353-86A | 5 | 86-90 Lower Rocker Cover Gasket (Rubber) | \$33.84 |
| C9280 | 17353-89 | 5 | 91-00 Lower Rocker Cover Gasket (Rubber) | \$25.21 |
| C9010 | 17354-86A | 5 | 86-90 Upper Rocker Cover Gasket (Rubber) | \$33.84 |

| Cometic # | OE# | Qty | Description | List |
|-----------|-----------|-----|---|----------|
| C9276 | 17354-89 | 5 | 91-00 Upper Rocker Cover Gasket (Rubber) | \$25.21 |
| C9283 | 17358-84A | 10 | 86-00 Center Rocker Cover Gasket (Rubber) | \$18.56 |
| C9295 | 17944-89 | 10 | 91-00 Seal, Lower Push Rod Cover | \$17.66 |
| C9836 | 18001-83X | 25 | 86-00 Valve Guide Seal (Viton w/ spring on wiper) | \$73.42 |
| C9311F5 | 25263-86 | 5 | 86-90 Cam Cover Gasket (.060" AFM Material) | \$67.40 |
| C9313F5 | 25263-90B | 5 | 91-00 Cam Cover Gasket (.060" AFM Material) | \$60.65 |
| C9220 | 25463-94 | 5 | 94-00 Clutch Cover O-Ring Replaces C9958 | \$35.43 |
| C9287 | 26432-76A | 10 | 86-00 Cylinder O-Ring (Viton) | \$11.93 |
| C9449 | 26433-77 | 10 | 86-90 O-Ring, Oil Pump Check Valve | \$9.26 |
| C9439 | 26434-76A | 10 | 86-90 O-Ring Oil Pump | \$7.95 |
| C9437 | 26434-91 | 0 | 91-00 O-Ring Oil Pump Cover | \$2.95 |
| C9399F | 26495-75 | 10 | 86-90 Oil Pump Gasket (.032" AFM Material) | \$9.26 |
| C9315F | 26495-89A | 10 | 91-00 Oil Pump Gasket (.032" AFM Material) | \$7.95 |
| C9481 | 26856-89 | 10 | 91-00 Umbrella Valve Seal | \$10.56 |
| C9290 | 26995-86A | 10 | 86-00 Intake Manifold Seal | \$19.11 |
| C9363 | 31433-84A | 5 | 91-93 Sealing Washer | \$6.17 |
| C9312F | 31488-81 | 10 | 86-00 Starter Gasket (.032" AFM Material) | \$7.66 |
| C9306F | 32591-80 | 5 | 86-00 Point Cover Gasket (.032" AFM Material) | \$11.13 |
| C9401 | 34624-77 | 10 | 86-90 Footpeg Stud Gasket | \$12.83 |
| C9310F5 | 34955-75X | 5 | 86-90 Primary Cover Gasket (.060" AFM Material) | \$105.16 |
| C9314F5 | 34955-89A | 5 | 91-00 Primary Cover Gasket (.060" AFM Material) | \$105.16 |
| C9353 | 35151-74 | 5 | 86-00 Motor Sprocket Shaft Seal | \$21.58 |
| C9354 | 37101-84 | 1 | 86-00 Shifter Shaft Seal | \$2.61 |
| C9286 | 63858-49 | 10 | 87-00 Rocker Cover Washer Gasket | \$5.86 |
| C9288 | 65324-83 | 10 | 86-92 Gasket Exhaust Port (OE Style Replacement) | \$47.81 |
| C9719 | 65324-83A | 10 | 86-00 Gasket, Exhaust Port (S/E Race Style) | \$40.42 |
| C9540 | 65324-83X | 10 | 86-00 Gasket, Exhaust Port Extreme Performance spiral wound | \$74.56 |

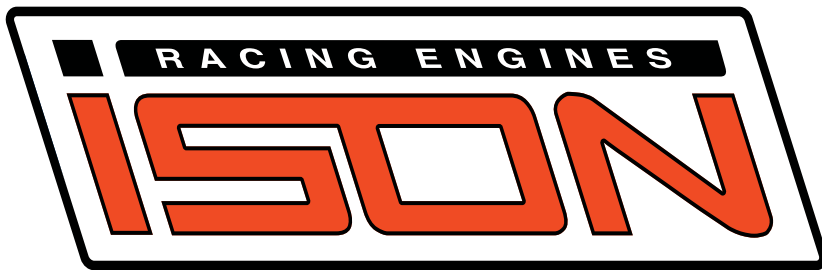

Phone (440) 853-2332

Address 8090 Auburn Road, Concord OH 44077

email sales@isonracingengines.com

web www.isonracingengines.com

www.facebook.com/IsonRacingEngines

@IsonRacing

Ison is a full service performance engine builder, serving the powersports and automotive industries.

Ison provides precision workmanship by our experienced staff for everything from complete engine builds and dyno testing, to component machining and assembly.

Outfitted with the finest equipment including Sunnen hones, Kwik-Way boring bars, Serdi seat cutters, and Haas 5-axis CNC mills, close tolerance machining and repeatability can be expected. To complete our expansive list of services, we have added engine dyno testing which is made possible by our new in-house Superflow 902S dyno.

Our extremely clean state-of-the-art facility is a testament to our principles and dedication to quality when working on your power plant.

NEW!

Superflow 902S Engine Dyno



Ison Services

Automotive Services

- Resurfacing and Square Decking
- Align Honing
- Boring and Sleeving
- Diamond Honing
- Dynamic Balancing
- Cylinder Head Reconditioning
- Standard and Radius Valve Job Capability
- Port Machining
- Valve Guide Reconditioning
- Valve Seat Repair
- Complete Engine Builds
- Engine Dyno Testing

Powersports and V-Twin Services

- 2 and 4 Stroke Cylinder Sleeving
- Port Matching
- Boring and Honing
- Case Boring
- Complete Cylinder Head Service

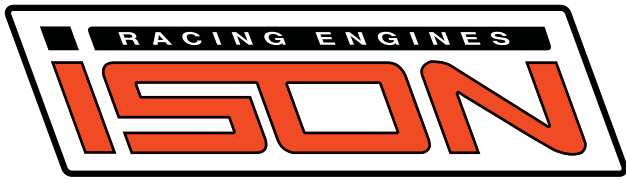

Toll Free - 1-800-752-9850

Ison Racing Engines • 8090 Auburn Rd., Concord, OH 44077

www.isonracingengines.com

POWERSPORTS ENGINE SERVICES ORDER FORM

Customer #: _____ Contact: _____ Date: _____

PO#: _____ Company Name: _____

Address: _____ City: _____ State: _____ Zip: _____

Phone: _____ Fax: _____ e-mail: _____

Make: _____ Model: _____ Year: _____

Parts sent in for services: _____

REQUIRED SERVICES - Check each box for services required

Cylinder Boring & Honing

| Part # | Description | List |
|--------------------------------|--|---------|
| <input type="checkbox"/> CB2 |2 Cycle / Per Hole up to 1mm over | \$60.51 |
| <input type="checkbox"/> CB2M | ...2 Cycle up to 1mm over | \$77.00 |
| <input type="checkbox"/> CB4 |4 Cycle / Per Hole up to 1mm over | \$55.00 |
| <input type="checkbox"/> CB4M | ...4 Cycle up to 1mm over | \$71.51 |
| <input type="checkbox"/> CB4SC | .4 Cycle, Briggs, Kohler per hole..... | \$88.00 |

Cylinder Honing

| Part # | Description | List |
|------------------------------|---------------------------------------|---------|
| <input type="checkbox"/> CH2 |2 Cycle / Deglaze Per Hole | \$27.51 |
| <input type="checkbox"/> CH4 |4 Cycle / Deglaze Per Hole | \$22.00 |

Cylinder Resleeving

| Part # | Description | List |
|-------------------------------|---|--|
| <input type="checkbox"/> CS2 |Most 2-Cycle w/o Power Valve..... (Labor only Sleeve price not included) | \$166.67 |
| <input type="checkbox"/> CS2V |Most 2-Cycle w/ Power Valve | \$200.00 (Labor only Sleeve price not included) |
| <input type="checkbox"/> CS4 |Most 4-Cycle drop in /per hole | \$86.67 (Labor only Sleeve price not included) |
| <input type="checkbox"/> CS4B |Most 4-Cycle where cylinder must | \$106.67 be bored to accept a larger sleeve/ per hole (Labor only Sleeve price not included) |
| <input type="checkbox"/> CS4C |4-Cycle where extensive machining is req. \$166.67 3mm or larger / Liquid cooled Big Bore (Labor only sleeve price not included per hole) | |

Additional Services

| Part # | Description | List |
|--------------------------------|--|-----------------------------|
| <input type="checkbox"/> CO4 | O-Ring 4 Cycle Block / per hole..... | \$40.00 |
| <input type="checkbox"/> GSKTM | Gasket removal multiple cylinder..... | \$53.34 |
| <input type="checkbox"/> GSKTS | Gasket removal single cylinder..... | \$33.34 |
| <input type="checkbox"/> HC | Heli Coil / Per Hole | \$46.67 |
| <input type="checkbox"/> SR | Remove Cylinder Head Stud | \$4.00 |
| <input type="checkbox"/> LH | Additional Labor (Per Hour)..... | \$85.00 |
| <input type="checkbox"/> BB | Bead Blast (Single Cylinder)..... | \$26.67 |
| <input type="checkbox"/> BC | Bore Cases (Single Cylinder) | \$69.34 |
| <input type="checkbox"/> PVA | Re-assemble Power Valve Complete | \$40.00 |
| <input type="checkbox"/> PMRP | Port Match Sleeve to existing | \$100.00 ported cylinder |

4-Cycle Head Services

| Part # | Description | List |
|--------------------------------|--|--|
| <input type="checkbox"/> VJ2VS | ..Valve Job 3 angle - 2 Valve Single | \$119.95 Cylinder Head (Disassembly, Inspection, Valve Job, Reassembly complete w/New Valve Stem Seals) |
| <input type="checkbox"/> VJ4VS | ..Valve Job 3 angle - 4 Valve Single | \$169.95 Cylinder Head (Disassembly, Inspection, Valve Job, Reassembly complete w/New Valve Stem Seals) |
| <input type="checkbox"/> VJ5VS | ..Valve Job 3 angle - 5 Valve Single | \$189.95 Cylinder Head (Disassembly, Inspection, Valve Job, Reassembly complete w/New Valve Stem Seals) |
| <input type="checkbox"/> VJM |Valve 3 angle - Multi Cyl. Head (ea)..... | \$38.95 |
| <input type="checkbox"/> VJOR |Valve Job +1mm/2mm | \$63.95 Oversize Radius (ea) |
| <input type="checkbox"/> VGRR | ...Valve Guide (removal, replace, resize,..... | \$28.95 guide not included) |
| <input type="checkbox"/> VSRR |Valve Seat (removal, replace, recut | \$68.95 (seat not included) |
| <input type="checkbox"/> CDH |Deck Cylinder Head/Base Single Head | \$52.95 |
| <input type="checkbox"/> CHHI |Deck Cylinder Inline | \$99.95 |

Additional Parts

| Description |
|---|
| <input type="checkbox"/> Pistons - Wiseco / CP / ProX |
| <input type="checkbox"/> Cometic Top End Gasket Set |
| <input type="checkbox"/> Top End Bearing (2-Stroke) |
| <input type="checkbox"/> Stainless Valves |
| <input type="checkbox"/> Titanium Valves |
| <input type="checkbox"/> Valve Stem Seals |
| <input type="checkbox"/> Hot Rod Crank Assembly |
| <input type="checkbox"/> Hot Rod Stroker Crank Assembly |
| <input type="checkbox"/> Main Bearings |
| <input type="checkbox"/> Main Seals |
| <input type="checkbox"/> Cometic Bottom End Gasket Set |
| <input type="checkbox"/> Klotz BeNOL Racing Castor Oil |
| <input type="checkbox"/> Klotz R50 Techniplate Lubricant |
| <input type="checkbox"/> Klotz Flexdrive Transmission Lubricant |
| <input type="checkbox"/> Klotz ATV/UTV Differential Lubricant |
| <input type="checkbox"/> Klotz MX4 4-Stroke Lubricant |
| <input type="checkbox"/> Klotz Chain Lube |
| <input type="checkbox"/> Klotz Foam Filter Oil |
| <input type="checkbox"/> Klotz Assembly Lube |



V-TWIN ENGINE SERVICES ORDER FORM

Customer #: _____ Contact: _____ Date: _____
 PO#: _____ Company Name: _____
 Address: _____ City: _____ State: _____ Zip: _____
 Phone: _____ Fax: _____ e-mail: _____
 Make: _____ Model: _____ Year: _____
 Parts sent in for services: _____

REQUIRED SERVICES - Check each box for services required

Cylinder Services

| Part # | Description | List |
|--------------------------------|---|----------|
| <input type="checkbox"/> HDHP | Hone Pan/Shovelhead (ea.) | \$55.00 |
| <input type="checkbox"/> HDH | Hone Evo & Twin Cam w/torque plates (ea.) | \$65.00 |
| <input type="checkbox"/> HDBP | Bore & Hone Pan/Shovelhead (ea.) | \$75.00 |
| <input type="checkbox"/> HDCB | Bore & Hone Evo & Twin Cam w/torque plates (ea.) | \$85.00 |
| <input type="checkbox"/> HDCBM | Multi pass Bore & Hone Evo & T/C w/torque plates (ea.) | \$95.00 |
| <input type="checkbox"/> HDCBB | 883 to 1200 Big Bore Conversion (ea.) | \$115.00 |
| <input type="checkbox"/> HDDC | Deck Cylinder Evo & Twin Cam (ea.) | \$45.00 |
| <input type="checkbox"/> HDS58 | Sleeve Evo & Twin Cam Cylinder, labor only (ea.) | \$150.00 |

Engine Case Services

| Part # | Description | List |
|--------------------------------|---|----------|
| <input type="checkbox"/> HDC58 | Bore Cases for Big Bore Cylinders (both holes) | \$260.00 |
| <input type="checkbox"/> HDSR | Remove studs Evo & Twin Cam (8 studs) | \$25.00 |
| <input type="checkbox"/> HDHT | Hot Tank Clean HD Engine Cases | \$30.00 |

Cylinder Head Services

| Part # | Description | List |
|--------------------------------|------------------------------------|----------|
| <input type="checkbox"/> HDCVJ | Complete Valve Service (per head) | \$150.00 |
| <input type="checkbox"/> HDCVS | Cut Valve & Seat (ea.) | \$36.00 |
| <input type="checkbox"/> HDIS | Install Seat (ea.) | \$75.00 |
| <input type="checkbox"/> HDIG | Install Guide (ea.) | \$30.00 |
| <input type="checkbox"/> HDRH | Resurface Head (ea.) | \$45.00 |
| <input type="checkbox"/> HDPR | FATSO Pushrod Conversion (ea.) | \$150.00 |
| <input type="checkbox"/> D3097 | Rocker Mod for Delkron heads (ea.) | \$25.00 |

Additional Parts

- | | | | | |
|--|--|--|--------------------------------------|--|
| <input type="checkbox"/> Cometic Top End Gasket Kit | <input type="checkbox"/> Cometic Complete Gasket Kit | | | |
| <input type="checkbox"/> Pistons | <input type="checkbox"/> Wiseco | <input type="checkbox"/> CP | <input type="checkbox"/> KB | <input type="checkbox"/> JE |
| <input type="checkbox"/> Main Bearing | <input type="checkbox"/> Pinion Bearing | | <input type="checkbox"/> Cam Bearing | |
| <input type="checkbox"/> Klotz Lubricants | <input type="checkbox"/> Engine | <input type="checkbox"/> Trans | <input type="checkbox"/> Primary | <input type="checkbox"/> Assembly Lube |
| <input type="checkbox"/> Oil filter | <input type="checkbox"/> Air filter | <input type="checkbox"/> Fuel filter | | |
| <input type="checkbox"/> Spark Plugs | <input type="checkbox"/> Wires | <input type="checkbox"/> MODOtek - Ignition System | | |
| <input type="checkbox"/> High Performance Cylinder Studs | <input type="checkbox"/> Twin Cam | <input type="checkbox"/> B/T Evo | <input type="checkbox"/> Shovelhead | |
| <input type="checkbox"/> High Performance Head Bolts | <input type="checkbox"/> Twin Cam | <input type="checkbox"/> B/T Evo | <input type="checkbox"/> Shovelhead | |
| <input type="checkbox"/> High Performance Engine Case Bolt Set | <input type="checkbox"/> Twin Cam | <input type="checkbox"/> B/T Evo | <input type="checkbox"/> Shovelhead | |
| <input type="checkbox"/> 2:1 Ratio Oil Pump Drive Gear Set | <input type="checkbox"/> Modified Breather Timer | | | |



Promotional Items

| Part # | Description | Price |
|--------|--|---------|
| DC15 | Package Decal 5.25" x 1.75" | \$.05 |
| DC06 | Decal Sheet 5.5" x 8.5" | \$1.00 |
| DC10 | Embroidered Patch 2" x 5" | \$2.00 |
| DC04 | Trailer Decal 6" x 19" | \$4.00 |
| DC03 | Decal 3.125" x 9" | \$1.00 |
| DC11 | Banner 3' x 8' | \$10.00 |
| DC17 | StreetPro Decal 1.625" x 9" | \$.50 |
| DC13 | Dealer Open House Kit | \$61.99 |
| | (100) DC01, (2) DC04, (2) DC11, (2) DC12, (10) 40% Off Retail Certificates, (25) Catalogs | |
| DC12 | Adjustable Embroidered Hat | \$10.00 |



BLOCK and HEAD SURFACE CLEANER

| Part # | Description | List |
|--------|-----------------|---------|
| C1047 | Single Can | \$9.31 |
| C1048 | Case of 10 Cans | \$88.82 |



Worldwide supplier of gaskets and engine sealing solutions for the Automotive Performance, Powersports, Original Equipment and Remanufactured Engine Industries.

WARRANTY DISCLAIMER*

Due to the nature of performance applications, the parts in this catalog are sold without any express warranty or any implied warranty of merchantability or fitness for a particular purpose. Comet Gasket Inc. shall not, under any circumstances, be liable for any special, incidental or consequential damages, including, person, party or property, but not limited to, damage, or loss of property or equipment, loss of profits or revenue, cost of purchased or replacement goods, or claims of customers of the purchase, which may arise and/or result from sale, installation or use of these parts.

Installation of these parts could adversely affect the motor manufacturers warranty coverage.

VENUE-The agreed upon venue, in the event of any dispute whatsoever between the parties, whether instituted by either party, including, but not limited to, contract terms, payment terms, delivery, type, defects, sufficiency of product, shall be the Court of Common Pleas, Lake County, Ohio or the Painesville Municipal Court, Lake County, Ohio, depending on the amount in controversy.

This agreement shall be governed by and construed under the laws of the State of Ohio.

All prices and terms are subject to change without notice.

Terms Open accounts may be established by well rated firms. A credit application is available upon request. Open accounts are due payable Net 30 days from date of invoice. No statement will be sent. If an account becomes 60 or more days past due, it is subject to being placed on credit hold. No orders will be shipped or new orders accepted until past due balance is paid. If an account becomes 90 or more days past due, it is subject to being placed for collections. All costs of collection are the responsibility of the customer, including attorney fees, court costs, and other expenses of litigation.

Returns- Authorization (RGA) must be obtained in advance on all returns. A packing slip or invoice number must accompany the merchandise. No returns after 30 days from invoice date. All returns are subject to a 25% restocking charge. All custom designed and custom manufactured gaskets are non-returnable. Only catalog parts are returnable.

Review your invoice and notify us immediately of any incorrect or inaccurate information. Shortages must be reported within 10 days.

This catalog uses the term "Harley-Davidson" and various model designations of Harley-Davidson Inc. solely for reference and fitment purposes. No affiliation exists between Comet Gasket and Harley-Davidson Inc., and the use of any trademarks or other proprietary designations of Harley-Davidson in this catalog should not be construed as indicating sponsorship or official approval by Harley-Davidson, Inc. of Comet Gasket or Comet products.



Made in the U.S.A.

OEM Production

One Source for Prototyping to Full Production

- Prototyping with economical tooling options.
- Full production Capabilities
- Quick turnaround
- In-house tool & die capabilities
- ISO 9001 :2008 Certified
- We can assist in developing a sealing solution for nearly any environment.
- Personal attention by our dedicated staff. We currently supply production to many customers in the automotive, marine, powersports, industrial, and power generator industries.
- Stamping, Laser Cutting, Rubber Injection Molding and 5 Axis Machining

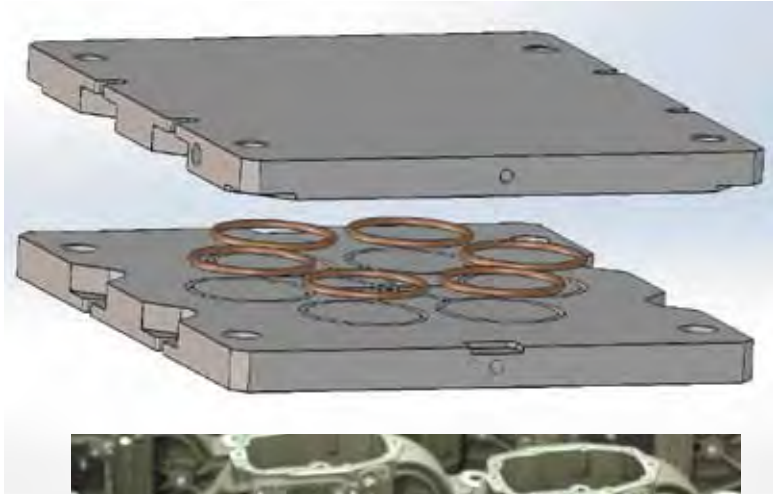

Flexibility is Key

We understand many variables go into determining design, volume, and production forecasts. We are accustomed to working in an ever changing environment.

Maintain knowledge base and part awareness during the transition from the early stages of development all the way through production, without the hassle of changing suppliers.

Inventory turns are important. We can work together for a delivery solution that best fits your inventory level and cash flow needs.



Call our Engineering Team today @ (440) 354-0777 for a quote



Contact Us

Order Toll Free By Calling (800) 752-9850

Cometic Gasket, Inc.
8090 Auburn Road
Concord, OH 44077

For Technical Assistance Call (440) 354-0777
Fax (440) 354-0350
email info@cometic.com
web www.cometic.com

Method of Payment Mastercard/VISA

Ship Via UPS Next Day Air / 2nd Day Air / Regular Ground / 3 Day Ground Service

facebook.com/cometic

@CometicGasket

Cometic Partners



Cometic Gasket, Inc. - An Exclusive NASCAR Performance® Product



The NASCAR Performance® logo and word mark are used under license by the National Association for Stock Car Auto Racing, Inc.

Copyright© 2016 Cometic Gasket, Inc.
Cover photo courtesy of James Pickett. RCH Racing photo courtesy of Simon Cudby.

PS16
Printed in U.S.A.

